



**VIGOR**<sup>®</sup> EQUIPMENT

**TOOL CATALOGUE**

**2025/26**



K-W25/EN/XX/0  
Errors excepted

[www.vigor-equipment.com](http://www.vigor-equipment.com)

**EINFACH VIGOR.**

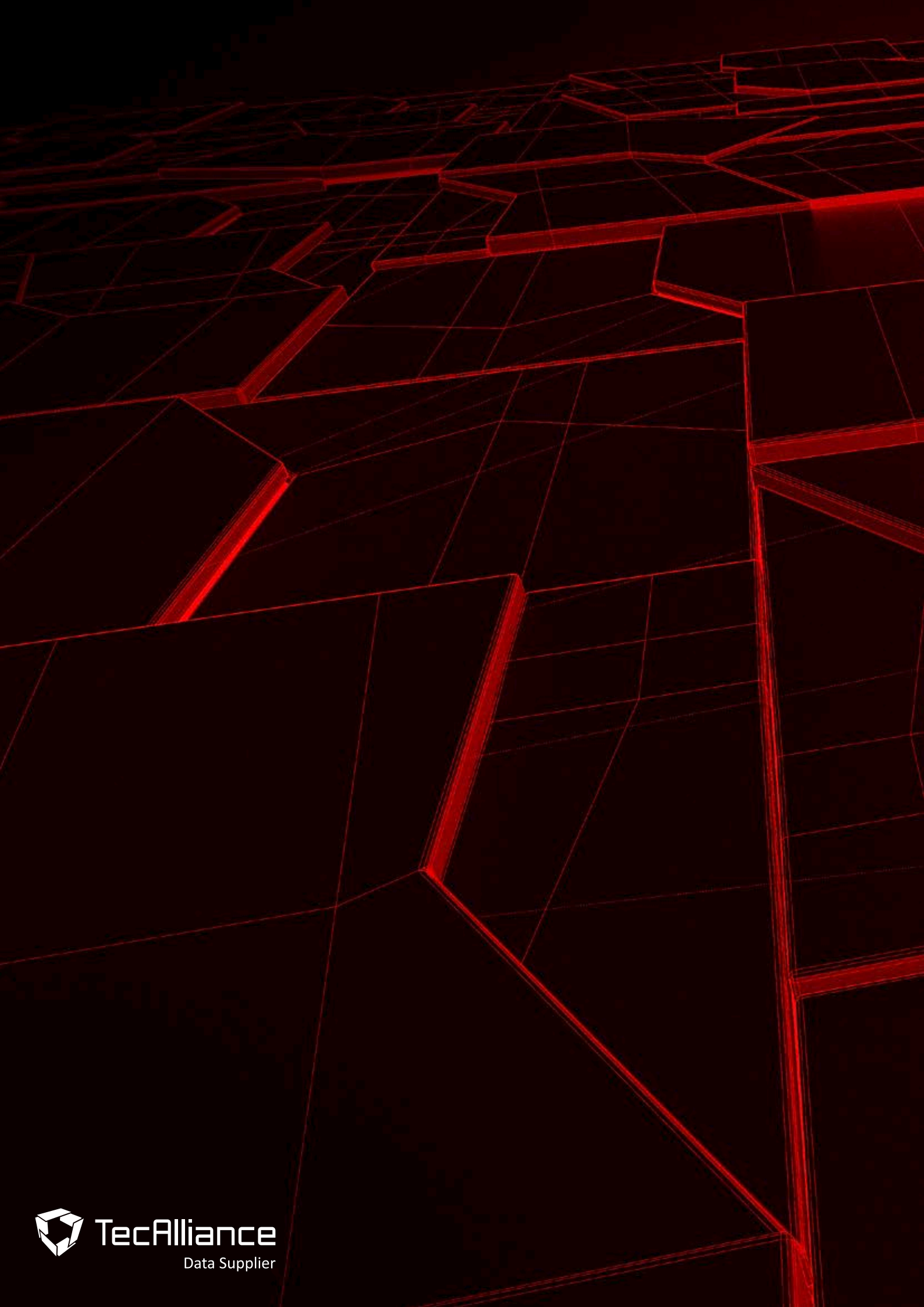

**TecAlliance**

Data Supplier



## Dear tool friend,

We're delighted to welcome you to our main catalogue.

This issue heralds a new era – as our main catalogue will now be published every two years. This decision enables us to enhance the quality and depth of our main catalogue. What's more, our Hot Deals brochures are even more up-to-date. This way, we guarantee that you get the best of both worlds: proven quality and depth in the main catalogue and exciting new products in the Hot Deals.

As you've come to expect from us, the Hot Deals will be published twice a year. These brochures are packed with exciting and innovative new products – perfectly tailored to seasonal needs and rapidly changing technologies. So you're sure to stay ahead of the game.





Thank you for being part of our VIGOR community. We look forward to continuing to provide you with our high-quality and effective tools – for outstanding results in your projects.

And now, have fun exploring your new VIGOR main catalogue. You can find us wherever you are. Be it on our social media channels, on our website or at one of our many dealers.

**Thank you for your trust.**

**Best wishes,  
Your VIGOR Team**



	<b>Tool trolleys and factory equipment</b>	→ 16–89
	<b>Tool storage</b>	→ 90–117
	<b>Hand tools</b>	→ 118–219
	<b>Torque tools</b>	→ 220–221
	<b>Pneumatic tools</b>	→ 222–228
	<b>General workshop tools</b>	→ 229–238
	<b>Diagnostics / Battery / Electrical System</b>	→ 239–246
	<b>Engine / Radiator / A/C</b>	→ 247–257
	<b>Oil service</b>	→ 258–263
	<b>Brakes</b>	→ 264–279
	<b>Wheels / tyres</b>	→ 280–292
	<b>Body</b>	→ 293–298
	<b>Motor / commercial vehicle chassis specialty tools</b>	→ 299–303

# Table of contents



Tool trolleys with assortment	19–39	Service trolley	54
Mobile work bench with assortment	40–43	Accessories for tool trolleys	55–63
Tool trolleys without assortment	44–50, 53	Storage system	64–81
Mobile work bench without assortment	51–52	Accessories for storage system	82–89

Multiboxes	92–93
Soft foam inserts	94–117

Sockets	120–168	VDE tools	201–204
Universal tool cases	169–170	Impact and releasing tools, scrapers	205–212
Wrenches	171–179	Various hand tools	212–213
Screwdrivers and bits	180–192	Cutting and sawing	213–219
Pliers	193–200		

Torque wrenches	221
Rotation angle tester	221

Impact wrenches	223–224
Air ratchets	225
Die grinder	226
Pneumatic air blow and body protection guns	227
Hose reel	228

Video borescope	240–241
Flue gas leakage tester	242
Electrical system	243, 245–246
Multimeter	243
Cable release tools	244
Crimping pliers set	245

Engine tools	248–251
Cooling system diagnostics	251–253
Turbo system diagnostics	254–255
Compression and pressure loss testers	256
Injector sealing seat cleaning	257

Oil dipsticks	259
Oil filter tensioner adjusters	260
Oil pumps and filling devices	261–263

Brake maintenance and bleeding	265–267
Brake piston readjusting tools	268–271
Brake disc tools	272–273
Tube flaring tools	274–276
Inspection tools	277–279

Impact sockets	281–284
Service jacks and jack stands	285–288
Wheel / tyre tools	289–292

Wiper arm puller set	294
Repair and installation sets	295
Induction heater and accessories	296–298

Motor vehicles chassis – Various	299–303
----------------------------------	---------



## Description of drive symbols

	For slotted screws
	For Phillips-Recess screws (PH)
	For Pozidriv screws (PZ)
	For inside hexagon screws
	For outside hexagon screws
	For inside hexalobular screws
	For tamper-resistant hexalobular screws (inside hexalobular screws with pin)
	For outside hexalobular screws
	For screws with internal serration XZN
	For spline socket screws
	For Polydrive screws
	For inside 5-star screws with centre pin
	For Tri-Wing® screws
	Nominal size 6.3 mm
	Nominal size 10 mm
	Nominal size 12.5 mm
	Nominal size 20 mm
	Nominal size 25 mm
	Inside square
	Outside square
	Inside hexagon
	Outside hexagon
	EN/IEC 60900:2004

## Description of icons

	Tools for motor vehicles
	Tools for trucks
	Operating instructions / Application note
	Central locking
	Weight of tool trolley
	Loading capacity of tool trolley
	Number of pieces
	Teeth
	Rotation angle
	Bore holes
	Shafts
	Magnet
	Operating time
	Charging time
	Weight
	Battery type
	Audible signal
	Working pressure
	Vibration
	rpm
	Sound level
	Max. loosening torque
	Twin hammer mechanism
	Coupler plug, nominal size
	Battery type
	Test equipment
	SUV/Van
	Agricultural machinery
	Industry
	QR Code
	Application video
	Hose length
	Oil capacity
	Hydraulic working
	Mechanical working

## A

Adapter / connection piece.....	129, 139–140, 158, 161, 164, 255, 263
Air blow gun.....	227–228
Air ratchet / air-operated power wrench.....	225, 283–284
Assembly trolley.....	19–28, 30–39, 44–50, 52–57, 59–62
Assortment / set.....	96–103, 105, 114–116, 120–122, 130, 141, 144, 161–168, 177, 181, 183, 185–187, 194, 196, 201, 203, 207, 209–212, 217, 231–233, 237, 245, 248, 250–252, 254–255, 257, 259, 262, 265–267, 275–276, 279, 283–284, 287–289, 294–295, 299

## B

Balance weight pliers.....	289
Balance weight tool.....	289, 291
Bits and screwdrivers.....	97–98, 104–105, 115, 123, 126–127, 129, 135–140, 142–144, 153–158, 180–192, 202–203
Bottle jack.....	287
Box-end wrench.....	97, 173–178
Brush.....	207, 209, 217–219, 237

## C

Cable release tools.....	244
Can holder.....	57
Cape chisel.....	206, 208
Car body tools.....	294–298
Car light tester.....	243, 245
Cardan shaft puller.....	301
Carpet knife.....	214–215
Case.....	92–93, 169–170
Centre punch.....	206, 208
Chassis tool.....	275, 277, 281–282, 289–292, 299, 301–303
Chisel.....	99, 115–116, 206
Circlip pliers.....	100, 194–197, 251
Clamping screw tool.....	299
Club hammer.....	205
Combination pliers.....	193, 200, 204
Combination wrench.....	172–173
Compression and engine leakage tester.....	256
Connection piece / adapter.....	117, 129, 139–140, 158, 161, 164, 255
Cooling system diagnostics.....	251–252
Corner base cabinet.....	76
Crimping pliers.....	245
Cross recess (PH) tool.....	127, 135, 180, 182, 202
Cutting knife.....	214–215

## D

Depth gauge.....	289
Diagnostic liquid.....	242
Diagnostics.....	203, 212–213, 221, 243, 245, 250–252, 254–256, 259, 273, 277, 289
Diagonal cutter.....	193, 200, 204
Die grinder.....	226
Double box-end wrench.....	173, 176, 178
Double open-end wrench.....	171
Double ratcheting box-end wrench.....	178–179
Double-joint pliers.....	98, 193

## D

Drawer.....	59
Drawer separation sheet.....	58
Drift pin.....	206, 209
Drift punch.....	206, 209
Drill.....	217
Drive-out pin.....	206, 209

## E

Engine leakage / compression tester.....	256
Extension.....	128, 139–140, 157, 202
Extractor socket set with spiral profile.....	146
Extractor socket with spiral profile.....	145, 159

## F

Feeler gauge.....	212
File.....	99, 216, 277
Fine tooth ratchet.....	122–123, 132, 149
Finger ratchet.....	123
Fixed castor.....	59
Flat chisel.....	206, 209
Flat wrench.....	104
Flexible / wobble extension.....	128, 140, 157
Flexible handle.....	149
Flexible screwdriver.....	184
Flue gas leakage tester.....	242
Foam mat.....	61
Forceps.....	232

## G

Gas torch.....	233
Grinding / Cutting / Machining.....	99, 213–217, 226, 238, 277
Grip pliers.....	98, 195–196
Guiding rail.....	60

## H

Hammer.....	99, 115–116, 205, 290
Hand riveting tool.....	198–199
Hexagon socket profile tool.....	127, 131, 137–139, 143, 147, 153–154, 202
Hexalobular tool.....	96, 98, 125–126, 131, 134–136, 142, 148, 152, 155–156, 183, 185, 187
Hinged-door cabinet.....	75, 78
Holder for paper reel.....	56
Hose clamp pliers.....	196–197, 251
HSS drill.....	217
Hydraulic service jack.....	285–286

**I**

Impact wrenches and sockets ..... 96, 100–101, 116, 146–147, 159–160, 162–163, 223–224, 281–284

Induction heater and accessories ..... 296–298

Injector sealing seat cleaning ..... 257

Inner bearing ring puller ..... 303

Inside wedge (Ribe CV) tool ..... 144, 156–157

Inspection tool ..... 277, 279

**J**

Jack stand and service jack ..... 285–288

Jack-knife ..... 214–215

Japan spatula ..... 231

**K**

Kneeling mat ..... 236

Knife / shears ..... 213–215, 217

**L**

Lambda sensor tool ..... 248

Lock ..... 60

**M**

Machinist's hammer ..... 205

Magnetic pick-up tool ..... 232

Measuring / testing ..... 203, 212–213, 221, 243–245, 250–252, 254–256, 259, 273, 277, 279, 289

Measuring cable set ..... 246

**M**

Mechanic's creeper ..... 93

Mobile work bench ..... 40–43, 51–52

Motor vehicle chassis / steering tie rod / shock absorber ..... 299

Motor vehicle electrics / electronics ..... 243–245

Motor vehicle wheel bearing tool ..... 302–303

Multi-purpose profile tool ..... 122, 126, 144, 153

Multi-Tool ..... 230

Multiboxes ..... 92–93

Multifunctional drain pan ..... 233

Multimeter / measuring cable ..... 243

**N**

Nut / socket ..... 96, 102–103, 114, 120–147, 149–168, 186, 201–202, 249, 281–284

**O**

Offset screwdriver ..... 105, 185

Oil service tools ..... 233, 259–262

Open-end wrench ..... 97, 174–175, 177, 179

**P**

Perforated plate ..... 84

Phase tester ..... 203

Pick-up tool with claws ..... 232

Plastic cover ..... 60

Pliers ..... 98–100, 105, 115–116, 193–200, 203–204, 245, 251, 289

Pneumatic tools ..... 96, 100–101, 116, 223–228, 283–284

Pozidriv (PZ) tool ..... 127, 135

Pry bar ..... 210–212

Pull-handle ..... 57, 61

Puller / extractor ..... 250, 294, 301, 303

**R**

Ratchet / ratcheting wrench ..... 97, 122–124, 132, 149–150, 161, 174–175, 177–178, 201

Ratchet box ..... 120–122, 130, 141, 144, 161, 163–168, 201, 283–284

Ratcheting combination wrench ..... 97, 174–175, 177

Ratcheting combination wrench with hinge ..... 97, 177

Refractometer ..... 251

Release lever ..... 210–212

Reversible ratchet ..... 122–124, 132, 149–150, 161, 201

Ribe CV tool ..... 144, 156–157

Rotary handle ratchet ..... 123–124, 132, 150

Rotation angle tester ..... 221

Round file ..... 216

Round-nose pliers ..... 204

Rubber hammer ..... 290

**S**

Sabre saw ..... 213–214

Safety platform ..... 238

Scraper ..... 99, 207, 209

Screw extractor ..... 145, 159

Screwdriver socket ..... 96, 104, 107, 126–127, 131, 135–139, 142–144, 147–148, 153–157, 202

Screwdrivers and bits ..... 96–98, 104–105, 107–108, 115, 123, 126–127, 129, 135–140, 142–144, 153–158, 180–192, 202–203

Seeger ring pliers ..... 100, 194–197, 251

Serration tool ..... 143, 154

Service jack ..... 285–288

Service jacks and jack stands ..... 285–288



# Alphabetical index of key words



## S

Service trolley.....	54
Set / assortment.....	96–103, 105, 114–117, 120–122, 130, 141–144, 161–168, 177, 181, 183, 185–187, 194, 196, 201, 203, 207, 209–212, 217, 231–233, 237, 245, 248, 250–252, 254–255, 257, 262, 265–267, 275–276, 279, 283–284, 287–289, 294–295, 299
Shears / knife.....	213–215, 217
Shock absorber tool.....	299–300
Sliding head.....	140
Sliding T-handle / sliding piece.....	124, 150, 161
Slot profile tool.....	127, 135, 180, 202–203
Snap ring pliers.....	100, 194–197, 251
Snipe nose pliers.....	193, 200, 204
Socket.....	96, 100–103, 114, 116, 120–147, 149–168, 186, 201–202, 249, 272, 281–282
Socket combinations.....	106, 120, 164–168
Socket wrench set.....	120–122, 130, 141, 144, 161, 163–168, 201, 283–284
Soff face hammer.....	205, 290
Soft foam insert.....	95–117
Soldering iron.....	233
Solid steel ratchet.....	122–123, 132, 149
Spanner socket set.....	120–122, 130, 141, 144, 161, 163–168
Spark plug tools.....	134, 152, 193, 249
Spatula.....	231
Specialty tool for	
brakes.....	265–268, 270–279
axles.....	301
electricians.....	201–204
wheels / tyres.....	281–282, 289–292
Spin type speeder.....	124
Square drive	
6.3 mm (1/4 inch).....	102–103, 114, 120–129, 164–168
10 mm (3/8 inch).....	126, 129–140, 152, 158, 169–170, 249
12.5 mm (1/2 inch).....	102–103, 114, 128, 140–147, 149–162, 164–168, 201–202, 225, 282–284
20 mm (3/4 inch).....	161–163
Steering wheel level.....	290
Storage shelf.....	61, 84
Stud extractor set.....	145
Supporting joint tool.....	299
Swivel castor.....	59
Synthetic repair tool.....	295

## T

T-handle screwdriver.....	105, 187
Tamper-resistant hexalobular tool.....	126, 135–136
Tape measure.....	212
Telescopic inspection mirror.....	231
Testing / measuring.....	221, 243, 256, 277, 279
Tool case / box.....	92–93, 169–170
Tool chest.....	45
Tool hook.....	62
Tool organisation.....	19–28, 30–57, 59–62, 67–69, 72, 75, 77–80, 82–89, 95–117
Tool trolley and accessories.....	19–28, 30–39, 44–50, 52–57, 59–62
Tools for engines.....	248, 250–251, 254–257
Tools for motor vehicles.....	243–245, 299, 302–303
Torque tool.....	221
Tray.....	233
Tube cutter.....	217
Tube flaring tool.....	274–276, 278
Turbo system diagnostics.....	250, 254–255
Twist drill bits.....	217

## U

Under-bench drawer cabinet.....	70–74
Universal joint.....	129, 139, 157, 163
Universal pliers.....	199

## V

V-ribbed belt tool.....	251
Vacuum and pressure pump.....	261
VDE tools.....	201–204
Vernier calliper.....	213
Vice.....	63
Video borescope.....	241
VIGOR 1000.....	23–25, 40–43, 51
VIGOR 1000 XD.....	37–38, 50
VIGOR 1000 XL.....	34–36, 39, 48–49, 52–53
VSS – VIGOR Storage System.....	62, 67–80, 82–89

## W

Wall cabinet.....	79
Wall unit.....	62, 67–80, 82–89
Window pane holder.....	235
Wiper arm puller.....	294
Wire brush.....	217
Wire stripper.....	204
Wobble / flexible extension.....	128, 140, 157
Wooden worktop.....	60
Work bench and accessories.....	40–43, 51–52
Work platform / ladder.....	238
Workshop equipment.....	62, 67–69, 72, 75, 77–80, 82–89, 233–236, 302
Worktop.....	60, 82–83
Wrench.....	97, 173–178
Wrenching bar.....	210–212

## X

XZN tools.....	131, 143, 148, 154
----------------	--------------------



# Numerical Index

VIGOR No.	Page	VIGOR No.	Page	VIGOR No.	Page	VIGOR No.	Page	VIGOR No.	Page
V1008	175	V1698	180	V1963-5	253	V2014	129	V2097	154
V1009	175	V1699	180	V1963-6	253	V2016N	133	V2098	154
V1010	175	V1700	180	V1963-7	253	V2017N	133	V2099	154
V1021	175	V1701	180	V1963-25	253	V2018N	133	V2100	154
V1022	175	V1702	180	V1963/28	252	V2019N	133	V2101	153
V1023	175	V1703	180	V1963N-0	252	V2020N	133	V2102	153
V1025	175	V1704	180	V1963N-6	252	V2027	203	V2103	153
V1026	175	V1707	217	V1963N-8	252	V2028	202	V2104	153
V1027	175	V1711-1	270	V1963N-9	252	V2029	202	V2105	153
V1028	175	V1711N	270	V1963N-A	252	V2030	202	V2106	153
V1029	175	V1713	213	V1963N-B	252	V2031-T15	203	V2107	153
V1030	175	V1714	212	V1963N-C	252	V2031-T20	203	V2108	140
V1031	175	V1715	213	V1963N-E	252	V2031-T25	203	V2109	158
V1138	203	V1722	243	V1963N-F	252	V2031-T30	203	V2110	158
V1208	180	V1728	275	V1963N-G	252	V2059	154	V2111	161
V1209	180	V1741	232	V1963N-H	252	V2060	154	V2113	154
V1212	205	V1764	232	V1963N-M	252	V2061	202	V2114N	140
V1213	207	V1781N	164	V1963N-R	253	V2062	202	V2115N	139
V1214	206	V1782	275-276, 278	V1963N-S	253	V2063	202	V2116N	140
V1215	206			V1963N-T	253	V2064	202	V2117N	139
V1216	206	V1783	206	V1963N-X	253	V2065	154	V2118N	139
V1217	206	V1787	216	V1970	47	V2066	154	V2119N	134
V1218	206	V1788	216	V1976	126	V2067	154	V2120N	134
V1219	206	V1789	216	V1977	126	V2068	154	V2121	154
V1220	206	V1790	216	V1978	126	V2069	153	V2122	154
V1221	206	V1801	216	V1979	126	V2070	153	V2123	154
V1222	206	V1802	196	V1980	126	V2071	140	V2124	154
V1281	260	V1803	196	V1981	126	V2072	153	V2126	154
V1283	207	V1804	196	V1982	126	V2073	153	V2128	154
V1293	164	V1808	196	V1983	126	V2074	153	V2129	154
V1301	212	V1897	122	V1984	126	V2075	153	V2130N	126
V1304	213	V1898	144	V1985	126	V2076	153	V2132	154
V1368N	207	V1901	18, 45	V1986	126	V2077	153	V2133	154
V1369	210	V1901/376	22	V1987	126	V2078	153	V2134	154
V1371	210	V1901-X	18, 46	V1988	153	V2079	153	V2135	154
V1371-1	210	V1901-X/376	26	V1989	153	V2080	153	V2136N	126
V1371-2	210	V1901-X/442	27	V1990	153	V2081	153	V2137	154
V1371-3	210	V1901-X/NKW	28	V1991	153	V2082	153	V2138N	126
V1371-4	210	V1902	45	V1992	153	V2083	153	V2139N	126
V1371-5	210	V1903	60	V1993	153	V2084	153	V2140N	126
V1371-6	210	V1904	60	V1994	153	V2085	153	V2141N	126
V1372	207	V1905	59	V1995	153	V2086	153	V2142N	126
V1409	187	V1906	59	V1996	153	V2087	154	V2143N	134
V1410	187	V1907	59	V1997	153	V2088	154	V2144N	134
V1423	290	V1908	59	V1998	153	V2089	154	V2145N	134
V1438	232	V1909	60	V1999	153	V2090	154	V2146N	134
V1446	215	V1917	142	V2000	153	V2091	154	V2149N	136
V1571	290	V1918	143	V2001	153	V2092	154	V2151	155
V1584	289	V1919	143	V2002	153	V2094	154	V2152	155
V1637	181	V1963-3	253	V2003	153	V2095	154	V2153	155
V1657	289	V1963-4	253	V2004	153	V2096	154	V2154	155

# Numerical Index



VIGOR No.	Page	VIGOR No.	Page	VIGOR No.	Page	VIGOR No.	Page	VIGOR No.	Page
V2155	155	V2213	156	V2285N	138	V2395	217	V2440N	127
V2156	155	V2214	156	V2286N	135	V2396	217	V2441N	127
V2157	155	V2215	156	V2287N	135	V2397	56	V2442N	126
V2160	155	V2216	156	V2288N	135	V2400	170	V2443N	126
V2161	155	V2217	156	V2289N	135	V2404N	145	V2444N	126
V2162	155	V2218	156	V2290N	135	V2404N-6	159	V2445N	126
V2163	155	V2219	156	V2291N	135	V2404N-7	159	V2446N	126
V2165	155	V2220	156	V2292N	135	V2404N-8	159	V2447N	126
V2167	155	V2221	156	V2293N	135	V2404N-9	159	V2452N	129
V2168	155	V2222	156	V2294N	135	V2404N-10	159	V2453N	124
V2169	155	V2223	156	V2295N	136	V2404N-11	159	V2454N	129
V2170	155	V2224	156	V2296N	136	V2404N-12	159	V2455N	128
V2171	155	V2225	156	V2297N	136	V2404N-13	159	V2456N	128
V2172	155	V2226	156	V2298N	136	V2404N-14	159	V2457N	128
V2173	155	V2227	157	V2299N	136	V2404N-15	159	V2458N	124
V2174	155	V2228	157	V2300N	136	V2404N-16	159	V2459N	251
V2175	155	V2229	157	V2301N	136	V2404N-17	159	V2460N	141
V2176	155	V2230	157	V2302N	136	V2404N-19	159	V2461N	166
V2177	155	V2231	157	V2303N	136	V2404N-21	159	V2462	60
V2178	155	V2232	157	V2305N	130	V2404N-22	159	V2465N	151
V2179	155	V2233	157	V2311N	133	V2404N-24	159	V2466	275
V2180	155	V2234	290	V2312N	133	V2404N-27	159	V2467	275
V2181	155	V2235	290	V2313N	133	V2404N-30	159	V2471	284
V2182	155	V2249	277	V2314N	133	V2404N-32	159	V2472	284
V2183	155	V2250	277	V2315N	133	V2413N	124	V2473	284
V2184	155	V2256N	162	V2317N	162	V2414N	121	V2474	284
V2185N	125	V2257	284	V2318N	161	V2415N	124	V2475	284
V2186N	125	V2261N	133	V2319N	161	V2416N	124	V2477	287
V2187N	125	V2262N	133	V2320N	162	V2417N	124	V2478	287
V2188N	125	V2263N	133	V2321N	162	V2418N	124	V2481	285
V2189N	125	V2264N	133	V2322N	161	V2419N	124	V2482	187
V2192N	126	V2265N	133	V2323N	162	V2420N	124	V2483	187
V2193N	137	V2266N	133	V2324N	162	V2421N	124	V2484	187
V2194N	137	V2267N	133	V2325N	162	V2422N	124	V2485	187
V2195N	137	V2268N	133	V2326N	162	V2423N	124	V2486	187
V2196N	152	V2269N	133	V2327N	162	V2424N	124	V2487	207
V2197N	152	V2270N	133	V2328N	162	V2425N	124	V2488	207
V2198N	155	V2271N	133	V2329N	162	V2426N	124	V2489	187
V2199N	155	V2272N	133	V2331N	162	V2427N	127	V2490	187
V2201	144	V2273N	133	V2332N	162	V2428N	127	V2491	210
V2202	156	V2274N	133	V2333N	162	V2429N	127	V2492	210
V2203	156	V2275N	133	V2334N	162	V2430N	127	V2493	210
V2204	156	V2276N	133	V2335N	162	V2431N	127	V2494	210
V2205	156	V2277N	133	V2336N	162	V2432N	127	V2495	210
V2206	156	V2278N	133	V2337N	162	V2433N	127	V2496	142
V2207	156	V2279N	138	V2338	236	V2434N	127	V2497	187
V2208	156	V2280N	138	V2379N	19	V2435N	127	V2498	187
V2209	156	V2281N	138	V2393	57	V2436N	127	V2499	245
V2210	156	V2282N	138	V2393-S	57	V2437N	127	V2499-A	245
V2211	156	V2283N	138	V2393-XD	57	V2438N	127	V2499-B	245
V2212	156	V2284N	138	V2394	217	V2439N	127	V2499-C	245



# Numerical Index

VIGOR No.	Page	VIGOR No.	Page	VIGOR No.	Page	VIGOR No.	Page	VIGOR No.	Page
V2499-D	245	V2571N	151	V2662-1000	205	V2823	174	V3562	181
V2499-F	245	V2572N	151	V2663-1500	205	V2824	174	V3571	251
V2501	187	V2573N	150	V2667N	150	V2825	174	V3597	180
V2502	187	V2574N	151	V2687N	165	V2826	174	V3598	180
V2503	187	V2575N	157	V2699N	125	V2827	174	V3599	180
V2504	187	V2576N	157	V2700N	125	V2828	174	V3600	180
V2505	187	V2577N	157	V2701N	125	V2829	174	V3601	180
V2506	187	V2578N	152	V2705	178	V2830	174	V3602	180
V2507	187	V2579N	151	V2712N	20	V2831	174	V3607	178
V2508	207	V2580N	151	V2722N	125	V2832	174	V3609	180
V2509	207	V2581N	151	V2723N	125	V2833	174	V3610	180
V2511N	259	V2582N	152	V2724N	134	V2837	103	V3613	180
V2512	289	V2584N	151	V2725N	134	V2838	103	V3635	175
V2513	289	V2585N	151	V2726N	134	V2924N	162	V3636	175
V2514	289	V2586N	151	V2727N	134	V2941	124	V3651N	129
V2515	289	V2587N	151	V2728N	134	V3277N	167	V3652N	140
V2516	289	V2588N	151	V2729N	134	V3309	217	V3653	224
V2517	62	V2589N	151	V2730N	152	V3330	202	V3661	299
V2518	62	V2590N	151	V2731N	152	V3331	202	V3670N	295
V2519	62	V2591N	151	V2732N	152	V3332	202	V3671N	295
V2520	62	V2592N	152	V2733N	152	V3333	202	V3672N	295
V2521	259	V2593N	127	V2734N	152	V3334	202	V3673N	295
V2522	284	V2594N	127	V2735N	152	V3335	202	V3676N	295
V2523	294	V2595N	126	V2762	287-288	V3336	202	V3677N	295
V2533N	125	V2596N	126	V2781	193	V3337	202	V3681	262
V2534N	125	V2597N	127	V2782	193	V3338	202	V3682	262
V2535N	125	V2598N	151	V2783	193	V3339	202	V3683	262
V2536N	125	V2599N	151	V2788	199	V3340	202	V3684	262
V2537N	125	V2600N	151	V2788-4.0	199	V3341	202	V3685	262
V2538N	125	V2603N	151	V2788-3.2	199	V3342	201	V3686	262
V2539N	125	V2613N	134	V2788-6.4	199	V3343	201	V3687	262
V2540	275	V2614N	134	V2788-4.8	199	V3344	202	V3688	262
V2542	170	V2615N	134	V2789N	277	V3366	183	V3689	262
V2551	275	V2616N	139	V2790N	214	V3367	183	V3690	262
V2552	275	V2626	217, 275	V2795	221	V3368	183	V3691	262
V2553	275	V2627	214	V2804	177	V3369	183	V3729	253
V2554	275	V2628	204	V2805	177	V3370	183	V3734N	120
V2555	275	V2629	204	V2806	177	V3381	251	V3735	198
V2556	275	V2630	204	V2807	177	V3391	183	V3735-M5	198
V2558	275	V2631	285	V2808	177	V3392	183	V3735-M6	198
V2559	275	V2632	285	V2809	177	V3393	183	V3735-M8	198
V2561N	151	V2639	285	V2810	177	V3427N	186	V3735-M10	198
V2562N	151	V2640	285	V2811	177	V3441	221	V3735-4.0	198
V2563N	151	V2641	204	V2812	177	V3451	217	V3735-4.8	198
V2564N	151	V2643	204	V2813	177	V3541	205	V3735-3.2	198
V2565N	151	V2645	259	V2814	177	V3551N	295	V3735-6.4	198
V2566N	151	V2647N	158	V2817	177	V3551N-ABS	295	V3738	195
V2567N	151	V2648	288	V2818	177	V3551N-PE	295	V3738-S	195
V2568N	151	V2662-300	205	V2820	175	V3551N-PP	295	V3739	195
V2569N	151	V2662-500	205	V2821	174	V3551N-PS	295	V3741N	146
V2570N	151	V2662-800	205	V2822	174	V3551N-W	295	V3760-0	269

# Numerical Index



VIGOR No.	Page	VIGOR No.	Page	VIGOR No.	Page	VIGOR No.	Page	VIGOR No.	Page
V3760-0-DISC	269	V4122	60	V4313	128	V4451-10	244	V4646M-9	237
V3760-1	268	V4126N	299	V4314	140	V4451-11	244	V4646M-10	237
V3760-2	268	V4130	102	V4315	140	V4451-12	244	V4646M-11	237
V3760-3	268	V4153	294	V4316	140	V4451-13	244	V4646M-12	237
V3760-4	268	V4154	294	V4317	157	V4451-14	244	V4646M-13	237
V3760-5	268	V4155	294	V4318	157	V4451-15	244	V4646M-14	237
V3760-6	268	V4156	294	V4319	157	V4451-16	244	V4646M-15	237
V3760-7	268	V4157	294	V4322	228	V4451-17	244	V4646M-16	237
V3760-8	269	V4158	294	V4324	243	V4451-18	244	V4646M-17	237
V3760-9	269	V4159	294	V4324-1	243	V4451-19	244	V4646M-18	237
V3760-11	268	V4160	294	V4324-2	243	V4451-20	244	V4646M-19	237
V3760-12	268	V4161	294	V4326N	246	V4451-21	244	V4646N-8	237
V3760-A	268	V4163	294	V4369	261	V4451-22	244	V4646N-9	237
V3760-A1	269	V4164	294	V4383	262	V4451-23	244	V4646N-10	237
V3760-B	268	V4165	294	V4384	262	V4461	256	V4646N-11	237
V3760-B1	269	V4188	102	V4385N	262	V4477	160	V4646N-12	237
V3760-C	268	V4192	254	V4398N	157	V4478	160	V4646N-13	237
V3760-D	268	V4199	186	V4399	273	V4481	18, 48	V4646N-14	237
V3760-E	268	V4200	186	V4411	265	V4481-X	18, 49	V4646N-15	237
V3760-F	268	V4201	261	V4413	260	V4481-X-4	57	V4646N-16	237
V3760-F1	269	V4201-1	261	V4414	260	V4481-X-5	61	V4646N-17	237
V3760-G	268	V4202	253	V4415	260	V4481-X/375	34	V4646N-18	237
V3760-G1	269	V4219	21	V4416	274	V4481-X/466	35	V4646N-19	237
V3760-H6	269	V4219-X	30	V4416-1	274, 276	V4481-X/499	36	V4646S-8	237
V3760-H7	269	V4221	186	V4416-2	274, 276	V4481-XD	18, 50	V4646S-9	237
V3760-IV	269	V4222	186	V4416-3	274, 276	V4481-XD-1	60	V4646S-10	237
V3760-J	268	V4223	186	V4416-4	274, 276	V4481-XD-2	59	V4646S-11	237
V3760-K	269	V4224	186	V4416-5	274	V4481-XD-3	59	V4646S-12	237
V3760-K1	269	V4225	186	V4418	183	V4481-XD-4	57	V4646S-13	237
V3760-K2	269	V4227	230	V4419	183	V4481-XD-5	61	V4646S-14	237
V3760-M	269	V4228	230	V4420	183	V4481-XD/469	37	V4646S-15	237
V3760-N	269	V4230	105	V4421	183	V4481-XD/775	38	V4646S-16	237
V3760-P	269	V4231	105	V4422	183	V4481-XXL	18, 53	V4646S-17	237
V3760-P1	269	V4233	254	V4425N	169	V4481-XXL/929	39	V4646S-18	237
V3760-Q	269	V4241	230	V4432/6	182	V4521	114	V4646S-19	237
V3760-R	269	V4248	299	V4433	182	V4542	32	V4651	214
V3760-S	269	V4249	299	V4434	182	V4560	24	V4655	181
V3760-T	269	V4250	299	V4435	182	V4560-X	31	V4661	205
V3760-V	269	V4274	215	V4436	182	V4561	25	V4661-1	205
V3760-VW	269	V4275	215	V4437	182	V4586	114	V4663	207
V3760-X	269	V4278	231	V4438	182	V4631	117	V4664	184
V3760-Z	269	V4279	231	V4451	244	V4632	117	V4665	184
V3760N	268	V4303	186	V4451-1	244	V4633	117	V4666	184
V3863	299	V4304	255	V4451-2	244	V4636N	303	V4667	180
V3898	221	V4305	255	V4451-3	244	V4637N	197	V4668	265
V3899	221	V4306	255	V4451-4	244	V4638	238	V4690	213
V4111	59	V4308	214	V4451-5	244	V4640	196	V4697	274
V4112	59	V4309	281	V4451-6	244	V4641	197	V4697-1	274
V4113	262	V4310N	211	V4451-7	244	V4642	301	V4697-2	274-276
V4114	262	V4311	128	V4451-8	244	V4646	237	V4700-A	93
V4115	262	V4312	128	V4451-9	244	V4646M-8	237	V4700-L	92



# Numerical Index

VIGOR No.	Page	VIGOR No.	Page	VIGOR No.	Page	VIGOR No.	Page	VIGOR No.	Page
V4700-R	93	V4941N-3	257	V4995	98	V5191	54, 59	V5550S-19	159
V4700-XL	92	V4941N-4	257	V4995-L	98	V5202	120	V5550S-21	159
V4700-XXL	93	V4941N-5	257	V4999N	100	V5434	33	V5550S-22	159
V4701	261	V4941N-10	257	V4999N-L	100	V5436	123	V5550S-24	159
V4708	185	V4941N-11	257	V5004	98	V5437	150	V5591	212
V4709N	151	V4941N-19T	257	V5004-L	98	V5461	168	V5601	185
V4726	104	V4941N-20	257	V5006	99	V5480	231	V5602	96
V4727	104	V4941N-22	257	V5006-L	99	V5485N	184	V5602-L	96
V4728	104	V4941N-245	257	V5009	117	V5488	233	V5603	101
V4729	104	V4941N-BK	257	V5017	99	V5489	18, 44	V5603-L	101
V4737	197	V4941N-BL	257	V5017-L	99	V5489-1	60	V5631	203
V4752	104	V4941N-M5	257	V5018	117	V5489-2	61	V5632	201
V4753	104	V4941N-R1	257	V5019	190	V5489-3	59	V5633N	100
V4758	54	V4941N-R2	257	V5020	191	V5489-4	59	V5633N-L	100
V4800N	223	V4941N-R3	257	V5024	162	V5489-5	61	V5634N	110
V4813	18, 51	V4941N-R4	257	V5025	162	V5494	193	V5634N-L	110
V4813-1	60	V4941N-R5	257	V5026	162	V5502	190	V5636N	110
V4813-2	61	V4941N-R6	257	V5042	180	V5505N	163	V5636N-L	110
V4813/NKW	40	V4941N-R7	257	V5043	180	V5505N-1/2	163	V5637N	110
V4814	18, 52	V4941N-R8	257	V5044	180	V5505N-1/4	163	V5637N-L	110
V4814-1	59	V4941N-R9	257	V5045	207	V5505N-3/8	163	V5638N	115
V4814-2	59	V4941N-R10	257	V5048	259	V5512	233	V5638N-L	115
V4814-3	59	V4941N-R11	257	V5055	23	V5513	276	V5639	199
V4814-4	60	V4941N-R12	257	V5068	98	V5513-1	276	V5639-24	199
V4884	149	V4941N-R13	257	V5068-L	98	V5513-2	276	V5650	193
V4884-01	149	V4942	185	V5070	99	V5513-3	276	V5660	251
V4885	211	V4944-REP	122	V5070-L	99	V5531	235	V5661	184
V4891	296	V4944-S	122	V5072	99	V5550L	147	V5671N	223
V4891-1	296	V4944-XS	123	V5072-L	99	V5550L-10	159	V5672	226
V4891-2	296	V4945-REP	132	V5075	97	V5550L-11	159	V5673	226
V4891-3	296	V4945-S	132	V5075-L	97	V5550L-12	159	V5674	225
V4891-4	296	V4946-REP	149	V5077	97	V5550L-13	159	V5675	225
V4891-5	297	V4946-S	149	V5077-L	97	V5550L-14	159	V5676	248
V4891-6	297	V4961	175	V5095	96	V5550L-15	159	V5677	233
V4891-7	297	V4962	175	V5095-L	96	V5550L-16	159	V5678	234
V4891-8	297	V4963	175	V5099	96	V5550L-17	159	V5691	277
V4891-9	297	V4964	175	V5099-L	96	V5550L-18	159	V5885	211
V4891-10	297	V4965	175	V5109	103	V5550L-19	159	V5909	277
V4891-3.5	298	V4966	175	V5109-L	103	V5550L-21	159	V5922	251
V4891-3.5-1	298	V4971N	95	V5111N	109	V5550L-22	159	V5930	282, 284
V4891-3.5-2	298	V4971N-L	95	V5111N-L	109	V5550L-24	159	V5931	282, 284
V4891-3.5-3	298	V4973N	95	V5154	41	V5550S	146	V5932	282, 284
V4891-3.5-4	298	V4973N-L	95	V5156	42	V5550S-10	159	V5933/3	284
V4891-3.5-5	298	V4975N	95	V5158	43	V5550S-11	159	V6000-01	72
V4891-3.5-6	298	V4975N-L	95	V5170	115	V5550S-12	159	V6000-01XD	72
V4891/6	297	V4987	97	V5170-L	115	V5550S-13	159	V6000-01XL	72
V4893	61	V4987-L	97	V5175	105	V5550S-14	159	V6000-02	75
V4930	273	V4989	97	V5175-L	105	V5550S-15	159	V6000-02XD	76
V4941N	257	V4989-L	97	V5180	54, 59	V5550S-16	159	V6000-02XL	76
V4941N-1	257	V4991	98	V5182	162	V5550S-17	159	V6000-03	78
V4941N-2	257	V4991-L	98	V5183	162	V5550S-18	159	V6000-3	69

# Numerical Index



VIGOR No.	Page	VIGOR No.	Page	VIGOR No.	Page	VIGOR No.	Page	VIGOR No.	Page
V6000-3-X	69	V6000-046XL	80	V6008	132	V6100	136	V6156	139
V6000-03D	78	V6000-047LR-E	89	V6012	149	V6101	136	V6157	139
V6000-03XD	79	V6000-047LRS-E	89	V6012-REP	149	V6102	136	V6158	139
V6000-03XL	78	V6000-047M-E	89	V6014	122	V6103	136	V6159	139
V6000-3P1	67	V6000-047MS-E	89	V6014-REP	122	V6104	136	V6160	139
V6000-3P1XL	67	V6000-048	84	V6015	116	V6105	136	V6161	139
V6000-3P1XL-X	67	V6000-050	86	V6015-L	116	V6106	137	V6194	139
V6000-3P2	68	V6000-051	86	V6017	131	V6107	137	V6200	209
V6000-3P2XL	68	V6000-052	87	V6018	131	V6108	137	V6200-2	209
V6000-3P2XL-X	68	V6000-053	87	V6019	131	V6109	137	V6200-3	209
V6000-04	79	V6000-054	87	V6027N	263	V6110	137	V6200-4	209
V6000-04XL	79	V6000-055	88	V6028	285	V6111	137	V6200-5	209
V6000-05	84	V6000-055XL	88	V6028-1	285	V6112	137	V6200-6	209
V6000-05S	84	V6000-056XL	77	V6028-2	285	V6113	137	V6200-7	209
V6000-05SP	84	V6000-058	77	V6028-3	285	V6114	137	V6200-8	209
V6000-05SXL	84	V6000-059	87	V6028-4	285	V6115	137	V6210-4	208
V6000-09	85	V6000-060	88	V6029	286	V6116	137	V6210-10	208
V6000-010	85	V6000-0676	82	V6029-1	286	V6117	137	V6220-10	209
V6000-011	76	V6000-0676-D	83	V6029-2	286	V6118	137	V6220-16	209
V6000-015	84	V6000-0676-X	82	V6029-3	286	V6119	137	V6220-20	209
V6000-015S	84	V6000-0676-XD	83	V6030	209	V6120	137	V6220-29	209
V6000-015S-E	84	V6000-0860	82	V6030-12	209	V6121	137	V6220/4	209
V6000-015SP	84	V6000-0860-X	82	V6030-16	209	V6122	137	V6221	55
V6000-015SXL	84	V6000-0861	82	V6030-20	209	V6123	137	V6230-5	208
V6000-017	84	V6000-0861-D	83	V6031	286	V6124	137	V6230-7	208
V6000-017XL	84	V6000-0861-X	82	V6031-1	286	V6125	137	V6309	281
V6000-018	84	V6000-0861-XD	83	V6031-2	286	V6126	137	V6311	281
V6000-018XL	84	V6000-01083-D	83	V6031-3	286	V6127	137	V6312/12	283
V6000-019	73	V6000-01083-XD	83	V6038	132	V6128	138	V6313	281
V6000-019XL	73	V6000-01357	82	V6038-REP	132	V6129	138	V6313-20.5	281
V6000-020	86	V6000-01357-D	83	V6048	179	V6130	138	V6313-21.5	281
V6000-029	70	V6000-01357-X	82	V6049	179	V6131	138	V6393	57
V6000-029XL	70	V6000-01357-XD	83	V6068	191	V6137	138	V6393-S	57
V6000-030	70	V6000-01541	82	V6082	135	V6138	138	V6394	56
V6000-030XL	70	V6000-01541-X	82	V6083	135	V6139	138	V6395	55
V6000-031	71	V6000-01725	82	V6084	136	V6140	138	V6396	55
V6000-031XD	71	V6000-01725-D	83	V6085	136	V6141	138	V6397	56
V6000-031XL	71	V6000-01725-X	82	V6086	136	V6142	138	V6398	54
V6000-032	73	V6000-01725-XD	83	V6087	136	V6143	138	V6399	62
V6000-032XL	74	V6000-02036	82	V6088	136	V6144	138	V6399-XD	62
V6000-033	74	V6000-02036-D	83	V6089	136	V6145	138	V6412/4	145
V6000-033XL	74	V6000-02036-X	82	V6090	136	V6146	138	V6435	236
V6000-035	75	V6000-02036-XD	83	V6091	136	V6147	138	V6435-XL	236
V6000-035XL	75	V6000-02215	82	V6092	136	V6148	138	V6436-L	236
V6000-037	77	V6000-02215-X	82	V6093	136	V6149	139	V6436-M	236
V6000-040/4	85	V6000-02404	82	V6094	136	V6150N	63	V6436-XL	236
V6000-041/4	86	V6000-02404-X	82	V6095	136	V6151	139	V6436-XXL	236
V6000-043	85	V6000-02588	82	V6096	136	V6152	139	V6452	300
V6000-044	80	V6000-02588-D	83	V6097	136	V6153	139	V6452-H6	300
V6000-044XL	80	V6000-02588-X	82	V6098	136	V6154	139	V6452-H7	300
V6000-046	80	V6000-02588-XD	83	V6099	136	V6155	139	V6452-H8	300



# Numerical Index

VIGOR No.	Page	VIGOR No.	Page	VIGOR No.	Page	VIGOR No.	Page	VIGOR No.	Page
V6452-1	300	V6640	111	V6799	198	V7001/4	292	V7037-IP8	126
V6452-5	300	V6640-L	111	V6800-50	218	V7002-14	249	V7037-IP10	126
V6452-6	300	V6643N	111	V6800-75	218	V7002-16	249	V7037-IP15	126
V6452-16	300	V6643N-L	111	V6801-65	219	V7002-18	249	V7037-IP20	126
V6452-17	300	V6650N	116	V6802	218	V7002-20.8	249	V7037-IP25	126
V6452-18	300	V6650N-L	116	V6803-75	218	V7002/4	249	V7037-IP27	126
V6452-19	300	V6685-1/20	58	V6803-100	218	V7014	165	V7037-IP30	126
V6452-21	300	V6685-2/20	58	V6804	219	V7014-4	125	V7037-IPR10	127
V6452-22	300	V6685-3/10	58	V6805	219	V7014-5	125	V7037-IPR15	127
V6452-24	300	V6685-4/10	58	V6806	219	V7014-6	125	V7037-IPR20	127
V6452-250	300	V6685H/5	58	V6807-4	217	V7014-7	125	V7037-IPR25	127
V6468	234	V6685H-2/20	58	V6807N	112	V7014-8	125	V7037-IPR27	127
V6500-140	200	V6685H-3/10	58	V6807N-L	112	V7014-10	134	V7037-IPR30	127
V6500-160	200	V6685H-4/10	58	V6808N	113	V7014-11	134	V7037-IPR8	127
V6500-190	200	V6686/5	58	V6808N-L	113	V7014-12	134	V7037-T8H	126
V6501-180	200	V6687/5	58	V6809	107	V7014-14	134	V7055-IP40	155
V6502-200	200	V6687H/5	58	V6809-L	107	V7014-16	134	V7055-IP45	155
V6503-200	200	V6688	58	V6809-4	217	V7014-18	152	V7055-IP50	155
V6504-125	199	V6688-XD	58	V6810	107	V7014-20	152	V7055-IP55	155
V6504-250	199	V6688-XL	58	V6810-L	107	V7014-22	152	V7055-IP60	155
V6510-10/4	194	V6688H	58	V6811	109	V7014-24	152	V7055-IPR40	156
V6510-19/4	194	V6688H-XD	58	V6811-L	109	V7015N	116	V7055-IPR45	156
V6510A-10	194	V6688H-XL	58	V6812	109	V7015N-L	116	V7055-IPR50	156
V6510A-19	194	V6689	56	V6812-L	109	V7017	148	V7055-IPR55	156
V6510A-40	194	V6721N	100	V6813	107	V7017-T30	159	V7055-IPR60	156
V6510B-10	194	V6721N-L	100	V6813-L	107	V7017-T40	159	V7055-T40H	156
V6510B-19	194	V6722N	100	V6814	108	V7017-T45	159	V7055-T45H	156
V6510B-40	194	V6722N-L	100	V6814-L	108	V7017-T50	159	V7055-T50H	156
V6510C-12	195	V6723N	101	V6816N	113	V7017-T55	159	V7055-T55H	156
V6510C-19	195	V6723N-L	101	V6816N-L	113	V7017-T60	159	V7055-T60H	156
V6510C-40	195	V6724N	112	V6817	108	V7017-T70	159	V7099	215
V6510D-12	195	V6724N-L	112	V6817-L	108	V7017-T80	159	V7099/2	215
V6510D-19	195	V6726N	112	V6818	108	V7018	148	V7120	279
V6510D-40	195	V6726N-L	112	V6818-L	108	V7018-M5	160	V7132N	271
V6554	225	V6740	250	V6821	106	V7018-M6	160	V7135	227
V6565	111	V6741	250	V6821-L	106	V7018-M8	160	V7135-150	227
V6565-L	111	V6742	234	V6822	106	V7018-M10	160	V7143-10	228
V6605	235	V6752-8	176	V6822-L	106	V7018-M12	160	V7158	272
V6606	235	V6752-9	176	V6831	114	V7018-M14	160	V7158-1	272
V6611/4	179	V6752-10	176	V6831-L	114	V7018-M16	160	V7158-2	272
V6612N	150	V6752-11	176	V6899N	224	V7018-M18	160	V7158-3	272
V6612N-REP	150	V6752-12	176	V6905	227	V7019	147	V7158-4	272
V6614N	123	V6752-13	176	V6906	226	V7019-H5	160	V7158-5	272
V6614N-REP	123	V6752-14	176	V6906-10	226	V7019-H6	160	V7158-6	272
V6632	269, 272	V6752-15	176	V6917	278	V7019-H8	160	V7158-7	272
V6633	269, 272	V6752-16	176	V6917-REP	278	V7019-H10	160	V7158-8	272
V6634	269, 272	V6752-17	176	V6952	212	V7019-H12	160	V7181	291
V6635	269, 272	V6752-18	176	V6956	301	V7019-H14	160	V7181-1	291
V6636	272	V6752-19	176	V6973	236	V7019-H17	160	V7181-2	291
V6638N	132	V6752/5	176	V6973-1	236	V7019-H19	160	V7181-3	291
V6638N-REP	132	V6752/12	176	V7001	292	V7031	179	V7181-4	291



# Numerical Index



VIGOR No.	Page	VIGOR No.	Page	VIGOR No.	Page	VIGOR No.	Page	VIGOR No.	Page
V7181-5	291	V7512-13	151	V7514L-12	125	V7730-14X15	171	V7750/12	173
V7181-6	291	V7512-14	151	V7514L-13	125	V7730-16X17	171	V7784	192
V7212	163	V7512-15	151	V7520	101	V7730-18X19	171	V7920-EP4	126
V7212-H14	163	V7512-16	151	V7520-L	101	V7730-20X22	171	V7920-EP5	126
V7212-H17	163	V7512-17	151	V7524	242	V7730-21X23	171	V7920-EP6	126
V7212-H19	163	V7512-18	151	V7524-1	242	V7730-24X27	171	V7920-EP7	126
V7212-H21	163	V7512-19	151	V7524-2	242	V7730-25X28	171	V7920-EP8	126
V7212-M14	163	V7512-20	151	V7524-3	242	V7730-30X32	171	V7920-EP10	134
V7212-M16	163	V7512-21	151	V7524-4	242	V7730/12	171	V7920-EP12	134
V7212-M18	163	V7512-22	151	V7524-5	242	V7740-6	172	V7920-EP14	134
V7259	279	V7512-23	151	V7524-6	242	V7740-7	172	V7920-EP16	134
V7283	89	V7512-24	151	V7524-7	242	V7740-8	172	V7920-EP18	152
V7283/2	89	V7512-27	151	V7524-8	242	V7740-9	172	V7920-EP20	152
V7285	262	V7512-30	151	V7524-9	242	V7740-10	172	V7920-EP22	152
V7286	262	V7512-32	151	V7524-10	242	V7740-11	172	V7920-EP24	152
V7287	262	V7512-36	151	V7525	302	V7740-12	172		
V7288	262	V7512/17	141	V7538-9	133	V7740-13	172		
V7323	96	V7512L-10	151	V7538-10	133	V7740-14	172		
V7323-L	96	V7512L-11	151	V7538-11	133	V7740-15	172		
V7324	101	V7512L-12	151	V7538-12	133	V7740-16	172		
V7324-L	101	V7512L-13	151	V7538-13	133	V7740-17	172		
V7385	260	V7512L-14	151	V7538-14	133	V7740-18	172		
V7401	273	V7512L-15	151	V7538-15	133	V7740-19	172		
V7402	238	V7512L-16	151	V7538-16	133	V7740-20	172		
V7403	238	V7512L-17	151	V7538-17	133	V7740-21	172		
V7471	266	V7512L-18	151	V7538-18	133	V7740-22	172		
V7471-A	266-267	V7512L-19	151	V7538-19	133	V7740-24	172		
V7471-T	266-267	V7512L-22	151	V7538/10	131	V7740-27	172		
V7471-TL	266-267	V7514-4	125	V7538L-9	133	V7740-30	172		
V7471-TS	266-267	V7514-5	125	V7538L-10	133	V7740-32	172		
V7471-W	266-267	V7514-6	125	V7538L-11	133	V7740-34	172		
V7471/17	267	V7514-7	125	V7538L-12	133	V7740-36	172		
V7471L-7	266-267	V7514-8	125	V7538L-13	133	V7740-38	172		
V7471L-8	266-267	V7514-9	125	V7538L-14	133	V7740-41	172		
V7471L-9	266-267	V7514-10	125	V7538L-15	133	V7740-46	172		
V7471L-10	266-267	V7514-11	125	V7538L-16	133	V7740-50	172		
V7471L-11	266-267	V7514-12	125	V7538L-17	133	V7740/6	173		
V7471L-12	266-267	V7514-13	125	V7538L-18	133	V7740/15	172		
V7471S-7	266-267	V7514-14	125	V7538L-19	133	V7740/22	172		
V7471S-8	266-267	V7514-4.5	125	V7548	245	V7750-6X7	173		
V7471S-9	266-267	V7514-5.5	125	V7548-1	245	V7750-8X9	173		
V7471S-10	266-267	V7514/13	121	V7600	189	V7750-10X11	173		
V7471S-11	266-267	V7514L-4	125	V7601-150	188	V7750-12X13	173		
V7471S-12	266-267	V7514L-5	125	V7601-250	188	V7750-14X15	173		
V7501-39	241	V7514L-5.5	125	V7603/3	189	V7750-16X17	173		
V7501/2	241	V7514L-6	125	V7614	189	V7750-18X19	173		
V7512-8	151	V7514L-7	125	V7638	189	V7750-20X22	173		
V7512-9	151	V7514L-8	125	V7730-6X7	171	V7750-21X23	173		
V7512-10	151	V7514L-9	125	V7730-8X9	171	V7750-24X27	173		
V7512-11	151	V7514L-10	125	V7730-10X11	171	V7750-25X28	173		
V7512-12	151	V7514L-11	125	V7730-12X13	171	V7750-30X32	173		



## Tool trolleys: organise your workplace!

Are you ready for more organisation in your workshop? Our tool trolleys not only get your tools into shape – they also roll efficiency directly to your workplace. Robust and reliable, just like your daily work.

With one of our tool trolleys, you have everything you need for your projects quickly to hand – without having to search for things.

Thanks to the well thought-out organisation and the smooth-running castors, you can easily move your tools from A to B.

Browse through our assortment and find the tool trolley that not only keeps your tools safe and organised – but also suits your working style. Because a well-organised workshop is the first step towards efficient work!

Looking for the perfect setup for your workshop? Our workshop equipment offers the perfect solution to make your workspace not only functional but also pleasant. From robust workbenches to practical storage systems – we have everything you need to create an environment that promotes efficiency and productivity.

Our products are specially developed to withstand the tough demands of the commercial sector. They not only offer stability and durability, but also flexibility to adapt to your growing needs. Whether you're planning a complete redesign of your workplace or simply want to improve individual elements – our workshop equipment is the reliable choice.





## Tool trolleys and factory equipment

Tool trolleys with assortment 19–39

Mobile work bench with assortment 40–43

Tool trolleys without assortment 44–50, 53

Mobile work bench without assortment 51–52

Service trolley 54

Accessories for tool trolleys 55–63

Storage system 64–81

Accessories for storage system 82–89

VIGOR No:	h x w x d mm	Total loading capacity kg	Worktop	Insert size	Insert dimension mm	Number of drawers	Loading capacity per drawer kg	Drawer slide-out	Drawer lock	
<b>V5489</b>		1000x677x459	400	Removable foam mat	L	563x393	7	20	100%	Central locking
<b>V1901</b>		1000x723x459	500	Solvent resistant plastic material	L	563x393	7	25	100%	Central locking
<b>V1901-X</b>		1000x723x459	500	Stainless steel worktop	L	563x393	7	25	100%	Central locking
<b>V4481</b>		1000x907x481	500	Solvent resistant plastic material	XL	750x393	8	25	100%	Central locking
<b>V4481-X</b>		1017x940x514	500	Stainless steel worktop	XL	750x393	8	25	100%	Central locking
<b>V4481-XXL</b>		1017x1625x695	1000	Stainless steel worktop	XD	790x570	13	30	100%	Central locking
<b>V4481-XD</b>		1017x986x695	500	Stainless steel worktop	XD	790x570	8	30	100%	Central locking
<b>V4813</b>		1000x1091x481	1000	Wooden worktop with collecting groove	L	563x393	8	40	100%	Central locking
<b>V4814</b>		1000x907x481	1000	Wooden worktop with collecting groove	XL	750x393	4	40	100%	Central locking

# Tool trolleys with assortment



V2379N, EAN 4047728055444



Tool trolley with assortment and mat

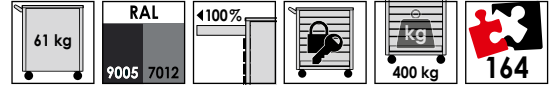

Drawer equipment variants:

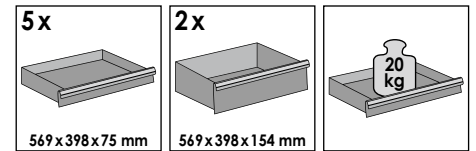
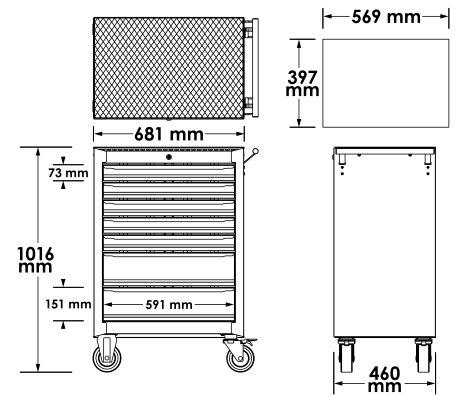

+ assortment

V5116



V6726N

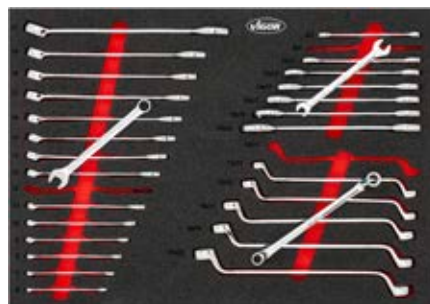

V5111N



V2712N, EAN 4047728055451



Tool trolley with assortment and mat

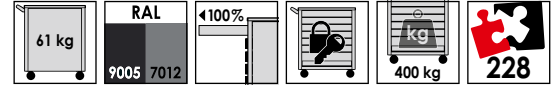

Drawer equipment variants:

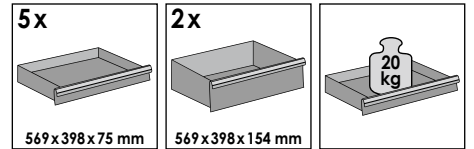
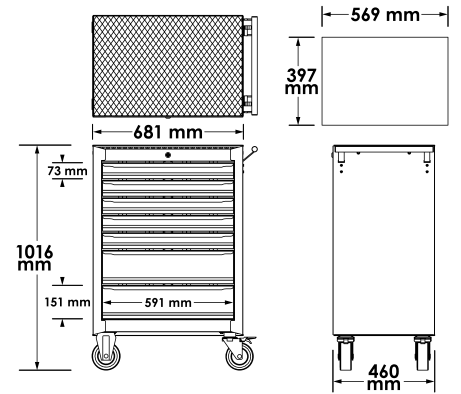

**+ assortment**

V2837

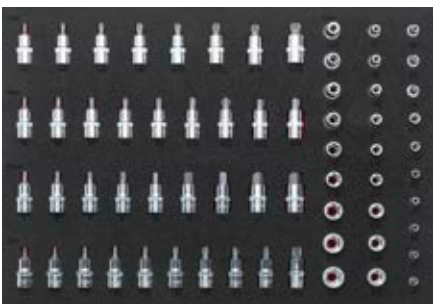

V6726N

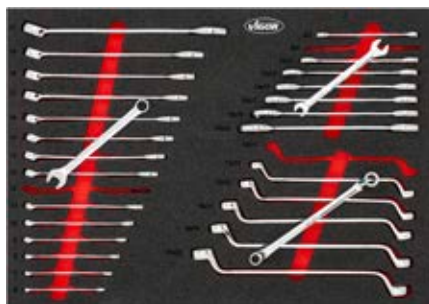

V5116



V5111N



# Tool trolleys with assortment



V4219, EAN 4047728042192



Tool trolley with assortment and plastic worktop

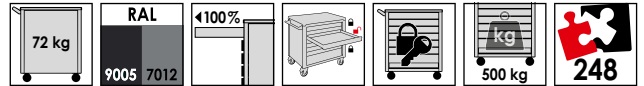

Drawer equipment variants:

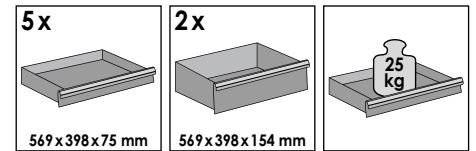
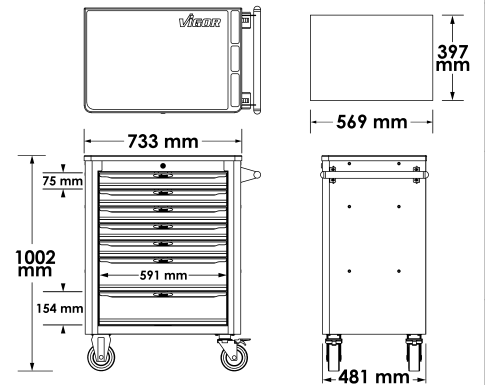

+ assortment

V6643N

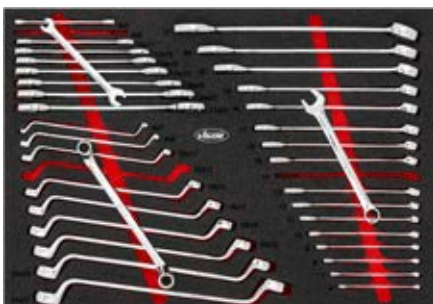

V4188



V5634N



V1901/376, EAN 4047728080293

**VIGOR**  
SERIES **L**

Tool trolley with assortment and plastic worktop

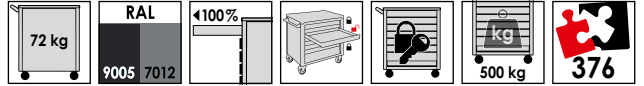

Drawer equipment variants:

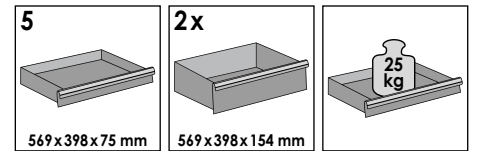
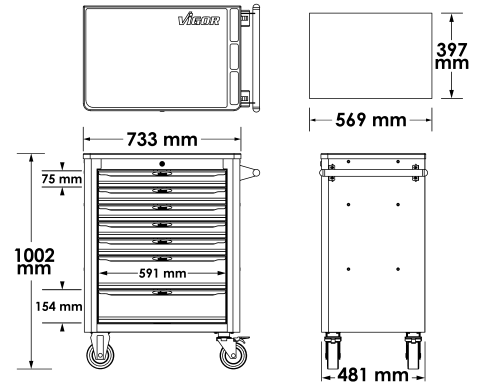

**+ assortment**

V4188



V4753

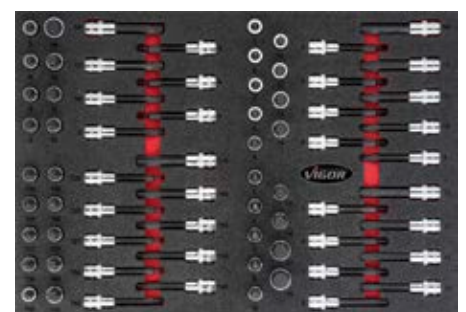

V6724N

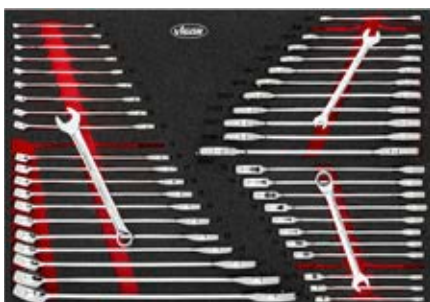

V5068



V5070

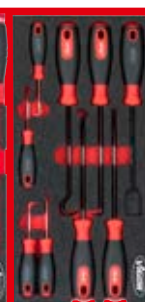

V5006



V5633N



V5603



V7324





# Tool trolleys with assortment



V5055, EAN 4047728050562



Tool trolley with assortment and plastic worktop

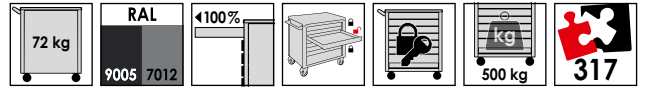

Drawer equipment variants:

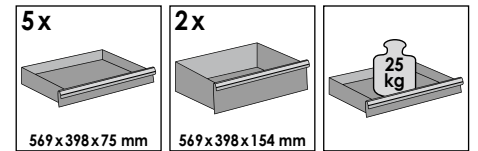
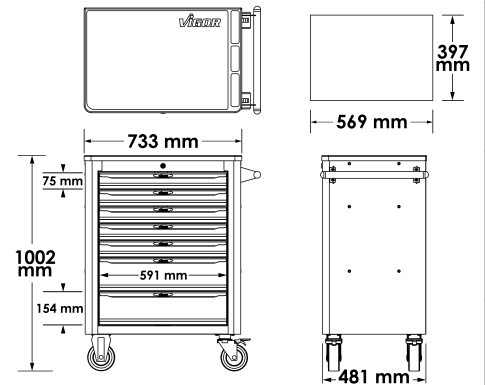

+ assortment

V4753

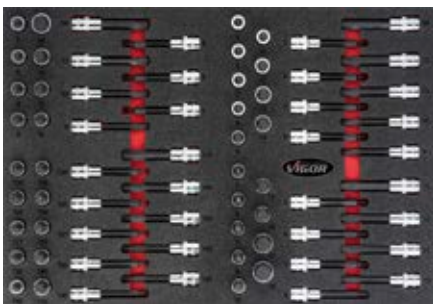

V6643N

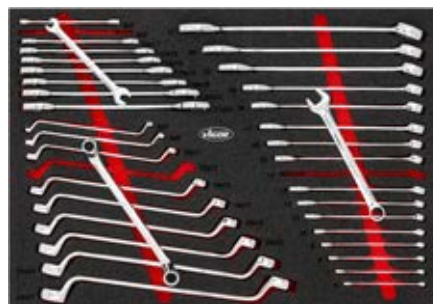

V4188



V5634N



V4560, EAN 4047728045605

**VIGOR**  
SERIES **L**

Tool trolley with assortment and plastic worktop

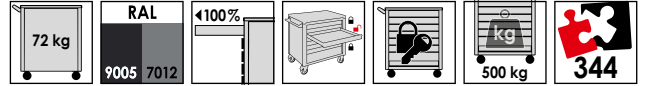

Drawer equipment variants:

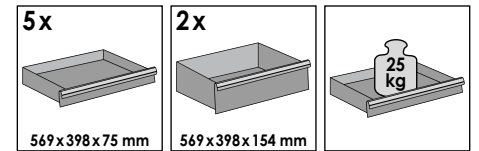
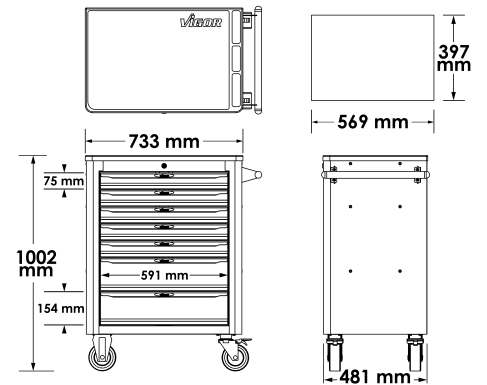

V4188



V2837

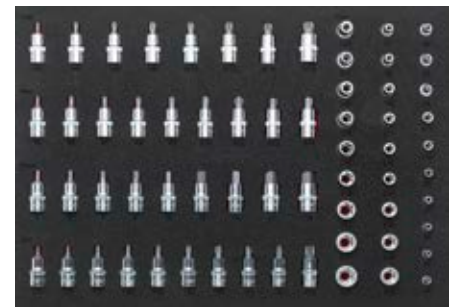

**+ assortment**

V4230



V5637N



V6643N

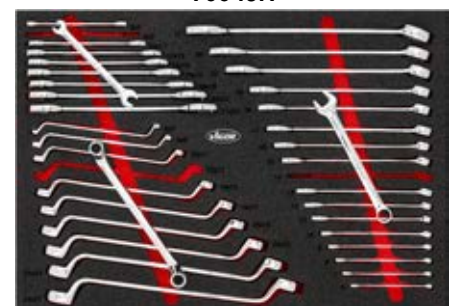

# Tool trolleys with assortment



V4561, EAN 4047728045810



Tool trolley with assortment and tool chest with plastic worktop

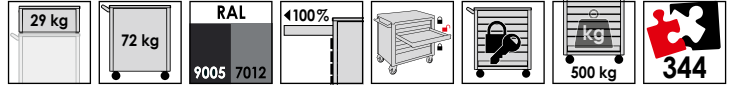

Drawer equipment variants:

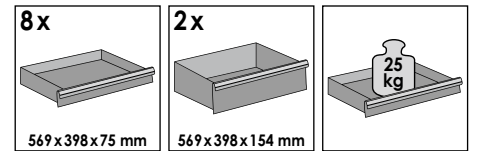
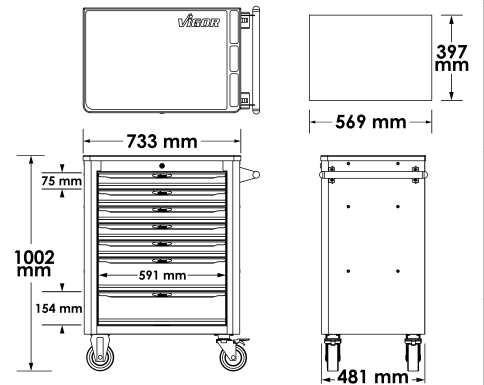

V4188



V2837

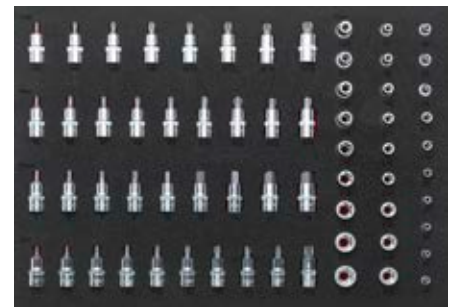

+ assortment

V4230



V5637N



V6643N

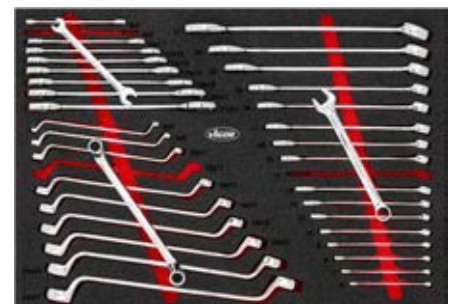

V1901-X/376, EAN 4047728084192

**VIGOR**  
SERIES **L**

Tool trolley with assortment and stainless steel worktop



**NEW**

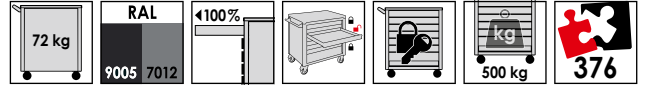

Drawer equipment variants:

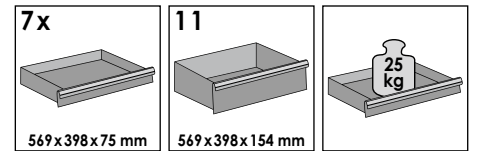
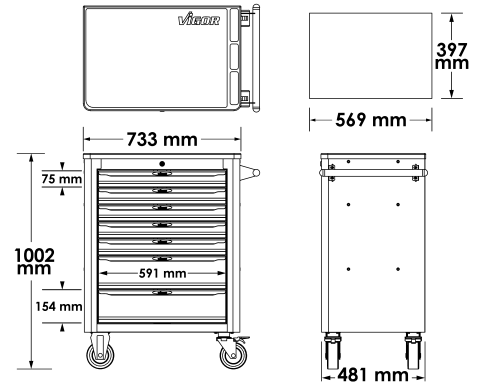

**+ assortment**

V4188



V4753

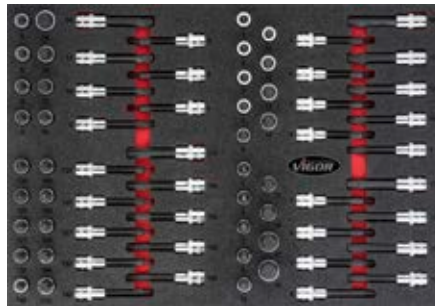

V6724N

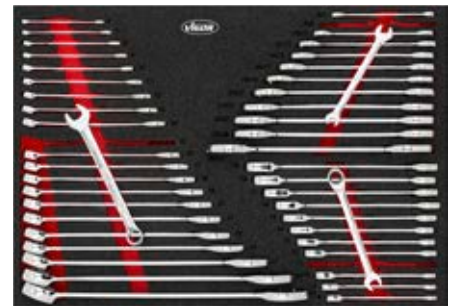

V5068

V5070

V5006



V5633N

V5603

V7324

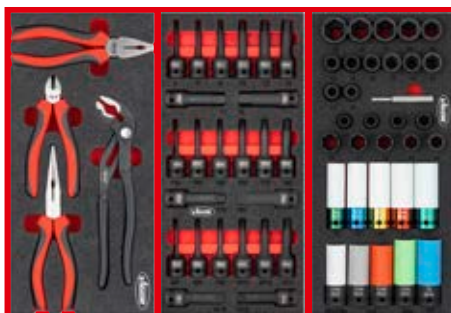

# Tool trolleys with assortment



V1901-X/442, EAN 4047728084338



Tool trolley with assortment and stainless steel worktop



**NEW**

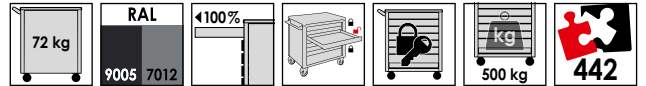

Drawer equipment variants:

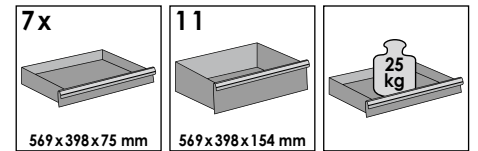
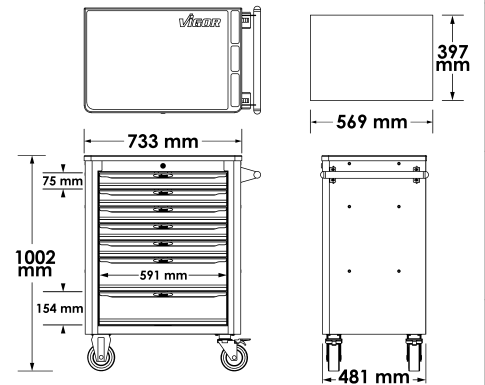

**+ assortment**



V4188

V4753

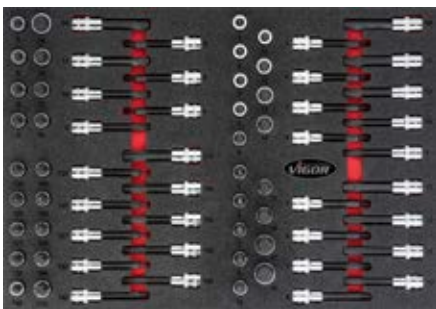

V6724N

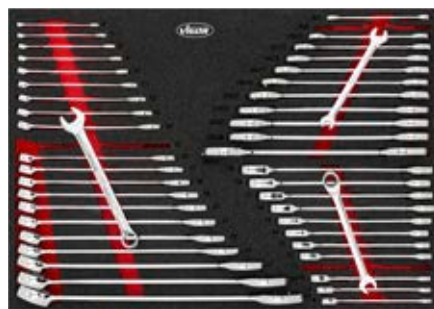

V5006

V5017

V4995



V5068

V4991

V5070



V5004

V5072

V5633N



V6811



V1901-X/NKW, EAN 4047728085601

**VIGOR**  
SERIES **L**

Tool trolley with assortment and stainless steel worktop



**NEW**

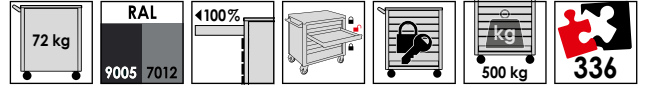

Drawer equipment variants:

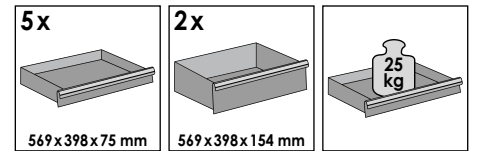
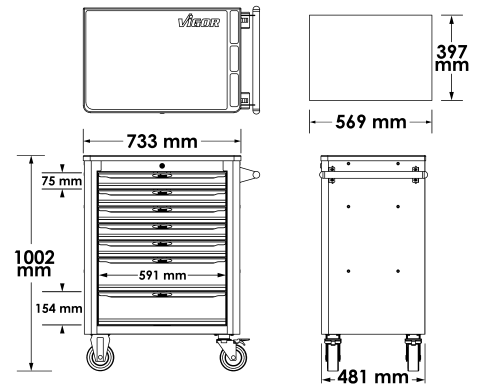

V5109

**+ assortment**



V6640



V6565

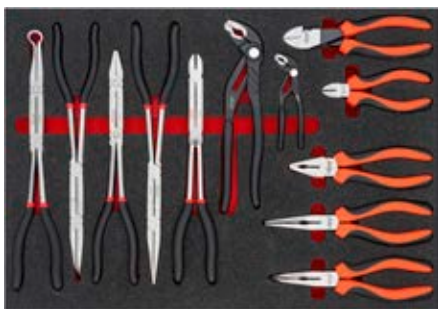

V4971N

V4973N

V4975N



V6813

V6807N



V6817

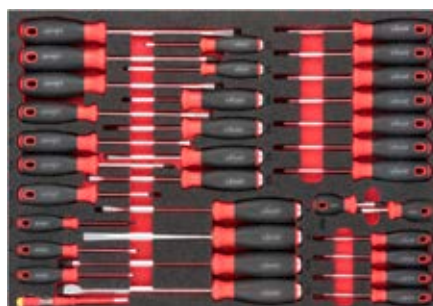



V4219-X, EAN 4047728084185

**VIGOR**  
SERIES **L**

Tool trolley with assortment and stainless steel worktop



**NEW**

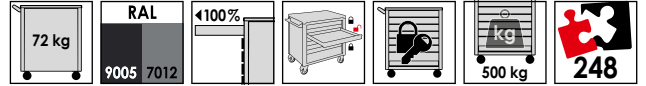

Drawer equipment variants:

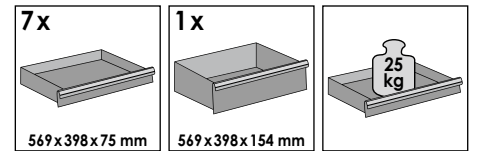
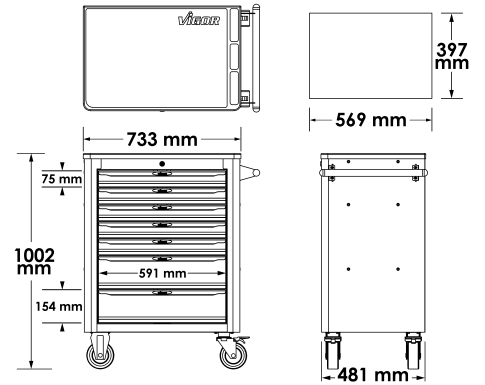

**+ assortment**

V4188



V5634N



V6643N

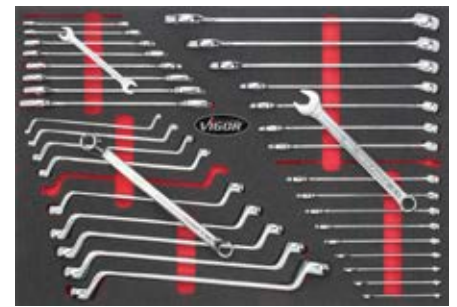



# Tool trolleys with assortment



V4560-X, EAN 4047728084178



Tool trolley with assortment and stainless steel worktop



**NEW**

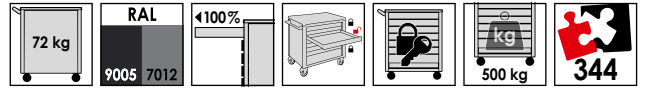

Drawer equipment variants:

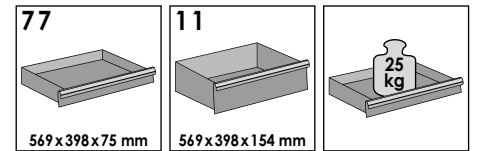
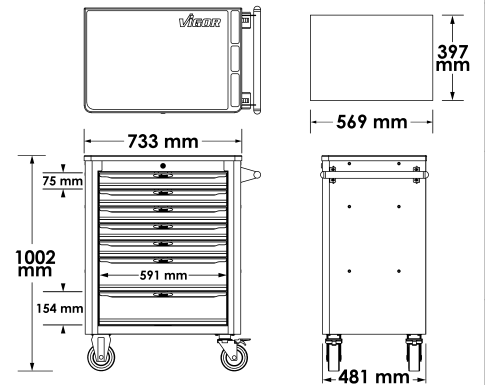

**+ assortment**

V4188



V6643N

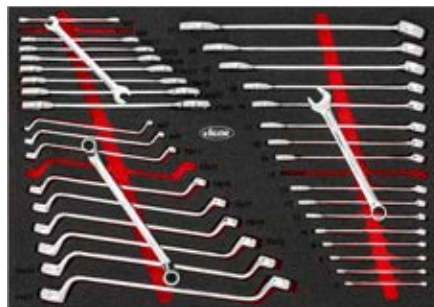

V4230



V5637N



V2837

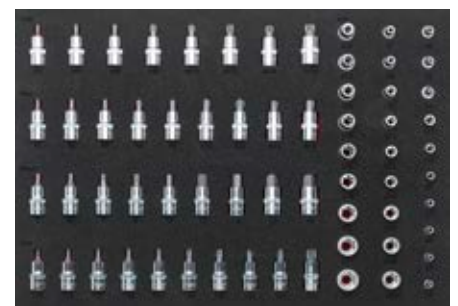

V4542, EAN 4047728045421

**VIGOR**  
SERIES **XL**

Tool trolley with assortment and plastic worktop

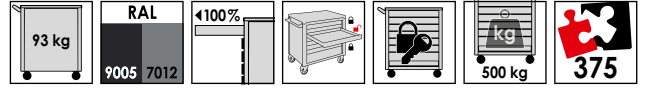

Drawer equipment variants:

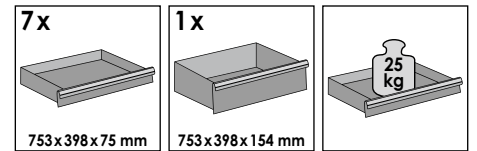
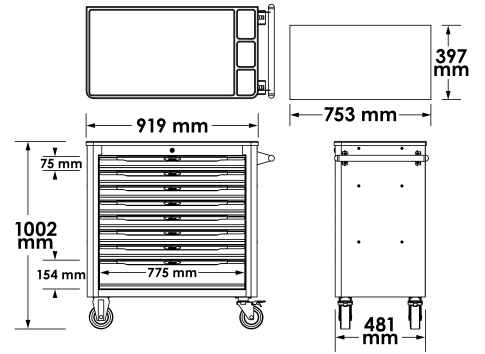

**+ assortment**

V4586



V6650N



V5170



V5638N



# Tool trolleys with assortment



V5434, EAN 4047728054348



Tool trolley with assortment and plastic worktop

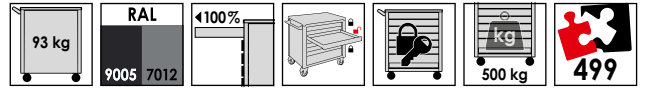

Drawer equipment variants:

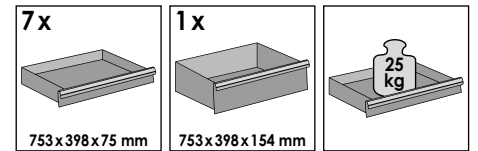
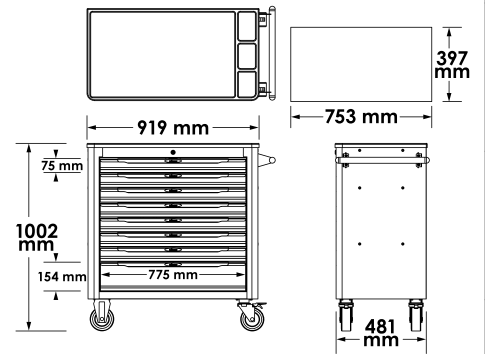

+ assortment

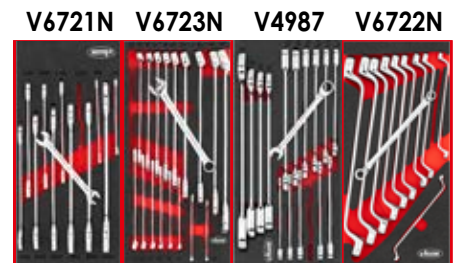
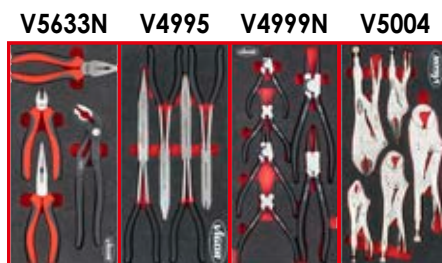
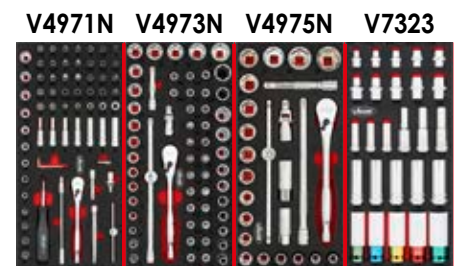
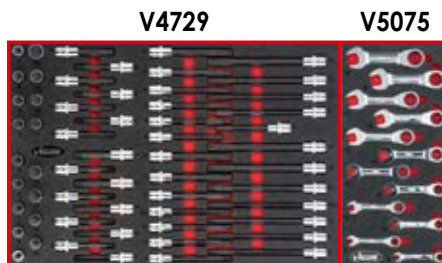
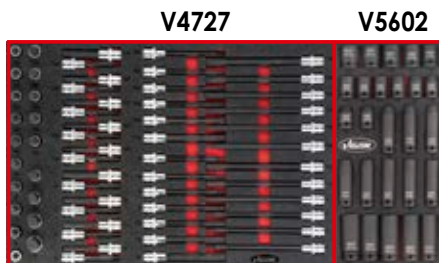

V4481-X/375, EAN 4047728062350

**VIGOR**  
SERIES **XL**

Tool trolley with assortment and stainless steel worktop

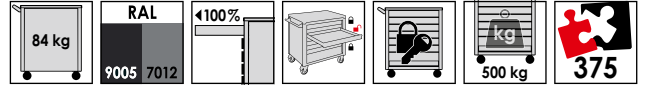

Drawer equipment variants:

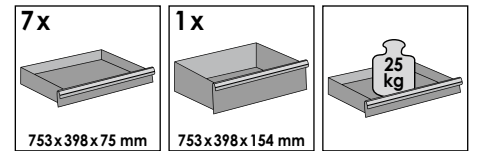
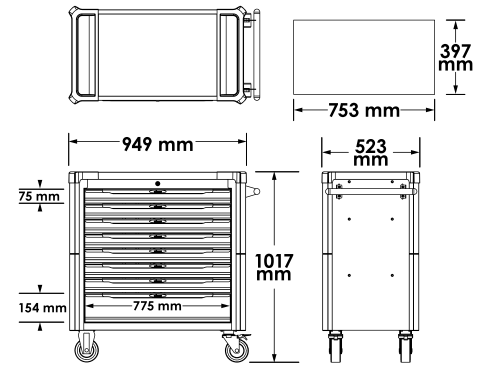

**+ assortment**

V4586



V6650N

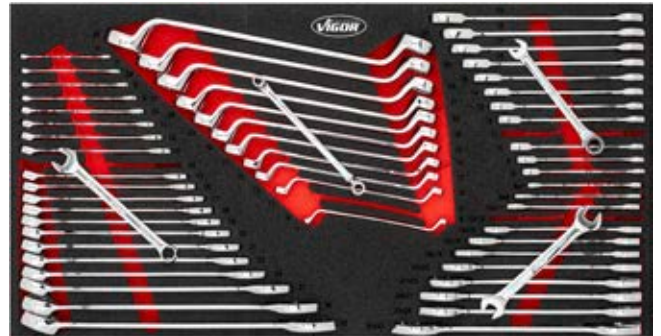

V5170



V5638N



# Tool trolleys with assortment



V4481-X/466, EAN 4047728074674



Tool trolley with assortment and stainless steel worktop



V2393-S

V6394



V4586

+ assortment



V6015



V6650N



V5170



V7015N

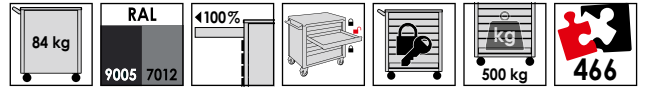

Drawer equipment variants:

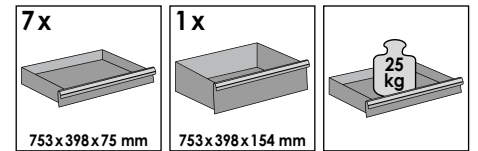
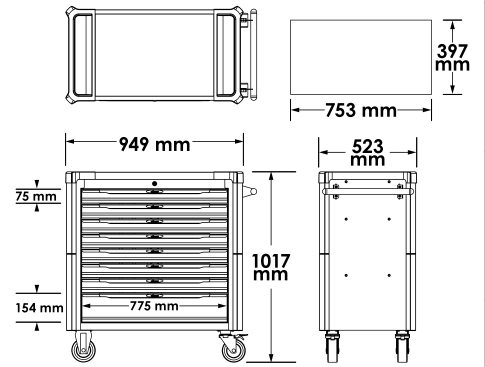

V4481-X/499, EAN 4047728062367

**VIGOR**  
SERIES **XL**

Tool trolley with assortment and stainless steel worktop

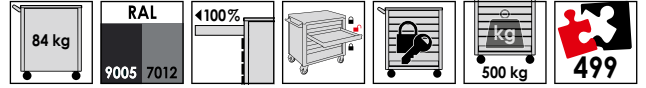

Drawer equipment variants:

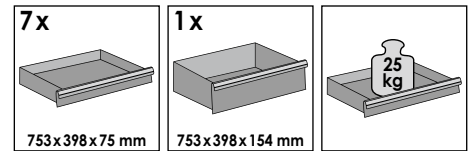
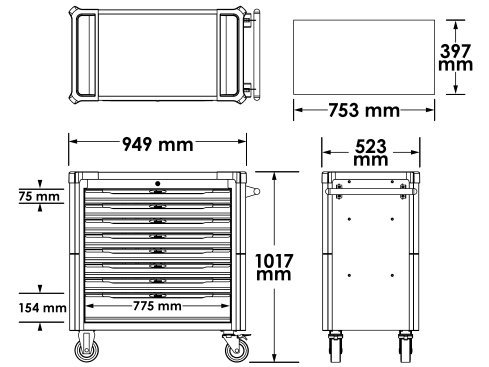

**+ assortment**

V4971N V4973N V4975N V7323

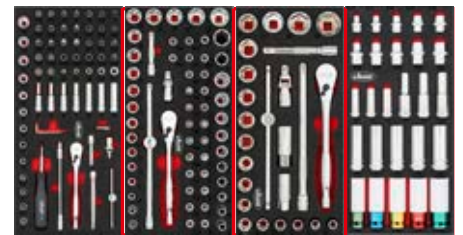

V4727

V5602



V4729

V5075



V6721N

V6723N

V4987

V6722N

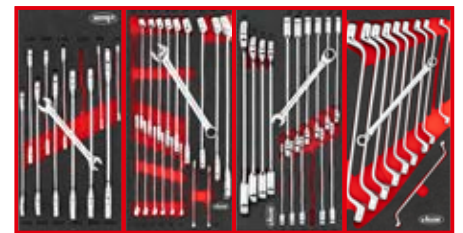

V5170



V5633N

V4995

V4999N

V5004

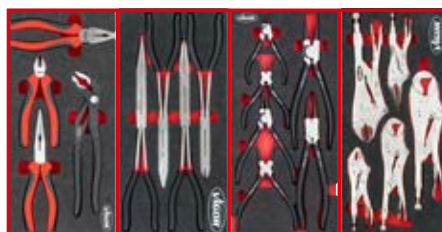

V5006

V5017

V5070

V5072



# Tool trolleys with assortment



V4481-XD/469, EAN 4047728068512



Extra-deep tool trolley with assortment and stainless steel worktop

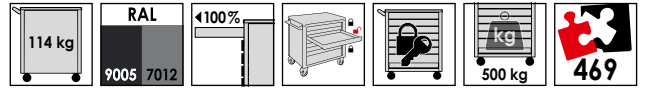

Drawer equipment variants:

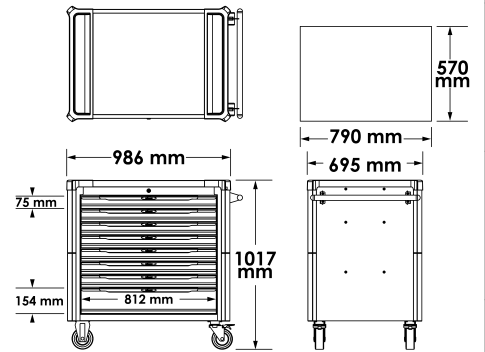

V4481 - EXTRA DEEP

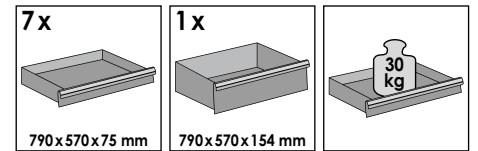

+ assortment



V6821



V6822



V6807N



V6808N



V6813



V6814



V6565



V6816

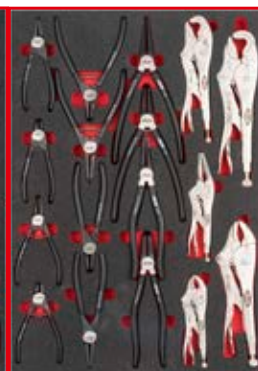

V4481-XD/775, EAN 4047728068529

**VIGOR**  
SERIES **XD**

Extra-deep tool trolley with assortment and stainless steel worktop

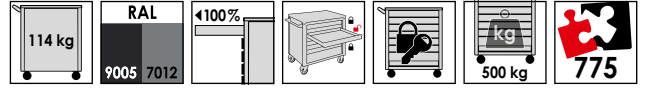

Drawer equipment variants:

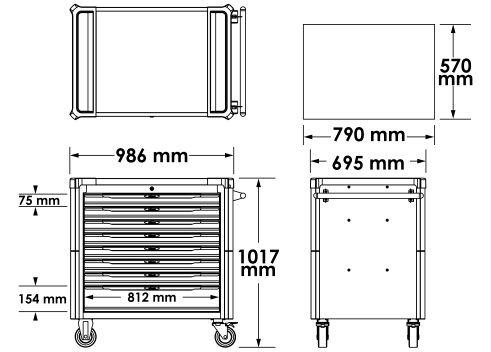

**V4481 - EXTRA DEEP**

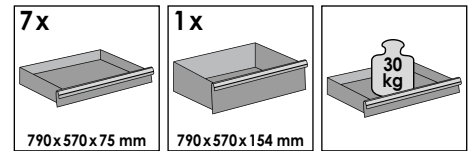

V6821 V6822

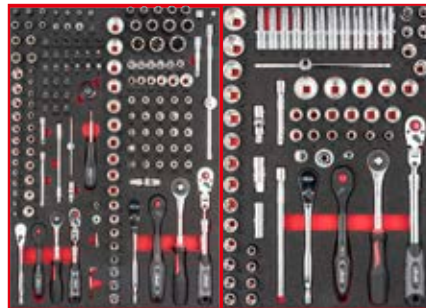

**+ assortment**

V6809 V6810

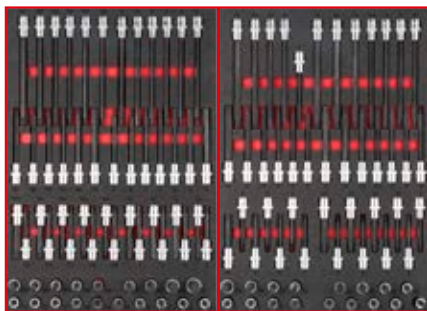

V6807N V6808N

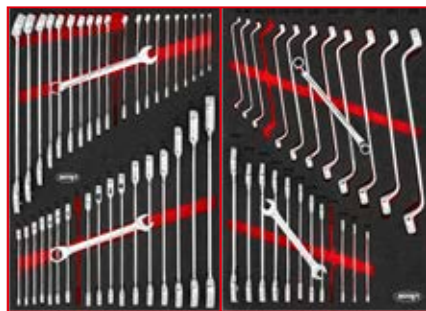

V6813 V6814



V6565 V6816N

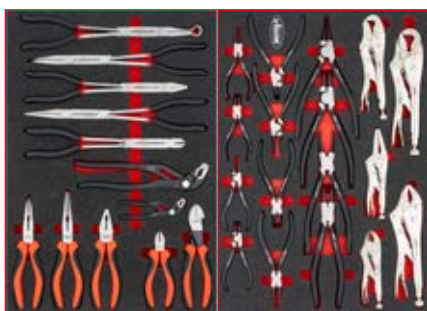

V6817 V6818



V6811 V6812

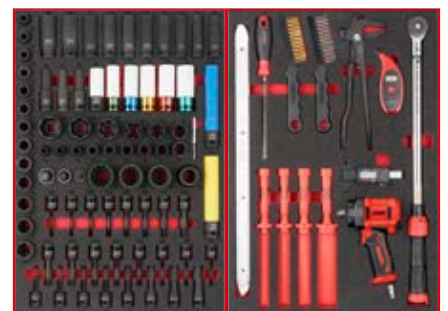



# Tool trolleys with assortment



V4481-XXL/929, EAN 4047728082303



Extra-deep, extra-wide tool trolley with assortment and stainless steel worktop



V6830

V6831

+ assortment



V6807N

V6808N

V6813

V6814

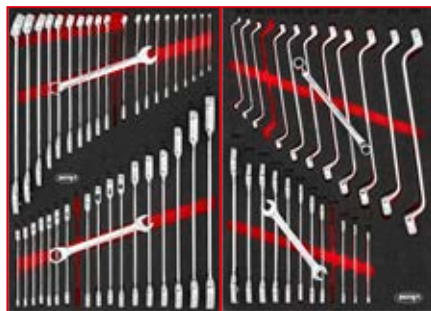

V6809

V6810

V6565

V6811

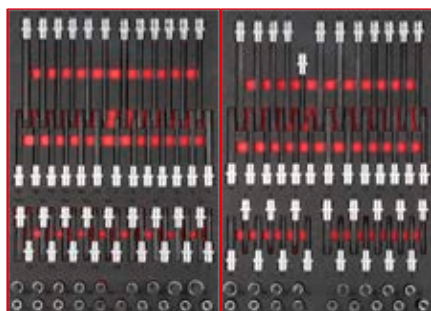

V2393-XD



V6817

V6818

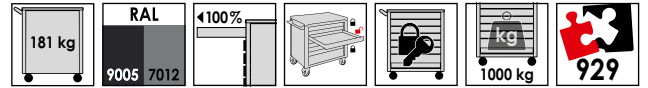

Drawer equipment variants:

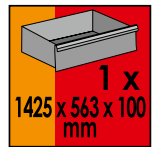
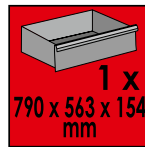
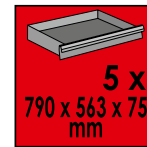
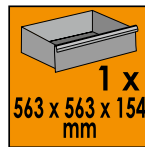
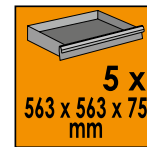
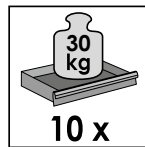
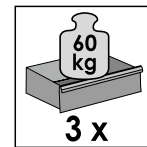

V4813/NKW, EAN 4047728085687

**VIGOR SERIES L**

**NEW**

Mobile work bench with assortment and wooden board

• Delivery without pull-handle



V5109

**+ assortment**

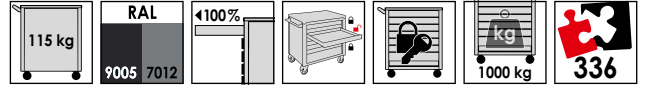

Drawer equipment variants:

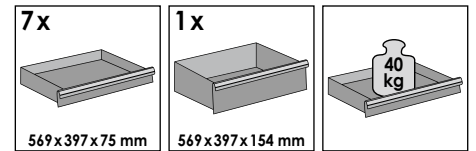
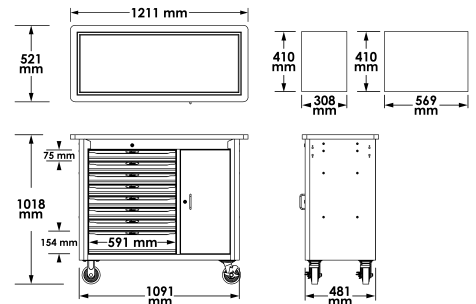

V6640

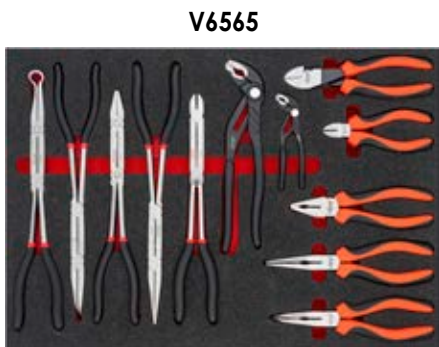

V6565



V6813



V6807N

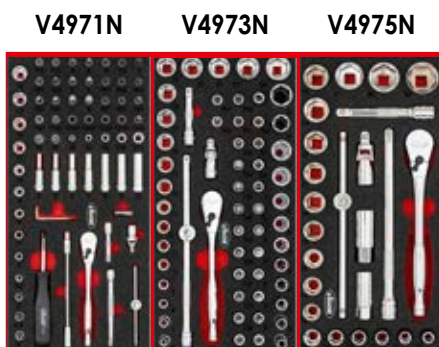

V4971N

V4973N

V4975N



V6817

# Mobile work bench with assortment



V5154, EAN 4047728083430



Mobile work bench with assortment and wooden board

• Delivery without pull-handle

**NEW**



**+ assortment**

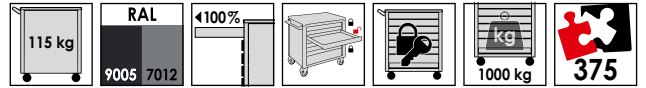

Drawer equipment variants:

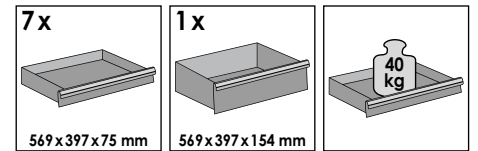
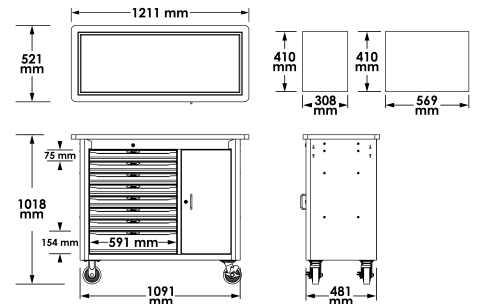

V4188



V4753

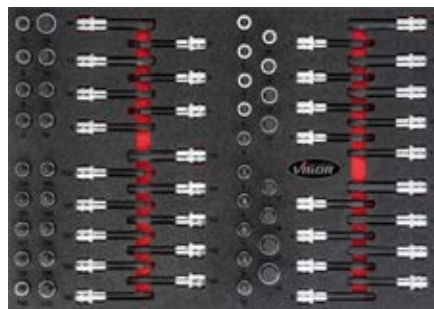

V5109



V5068

V5070

V5633N



V6724N



V6817



V5156, EAN 4047728051569

**VIGOR**  
SERIES **L**

Mobile work bench with assortment and wooden board

• Delivery without pull-handle

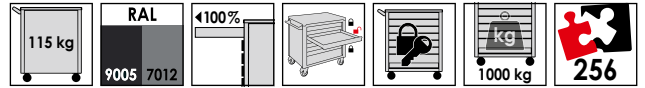

Drawer equipment variants:

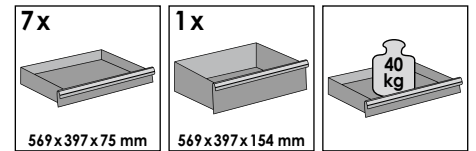
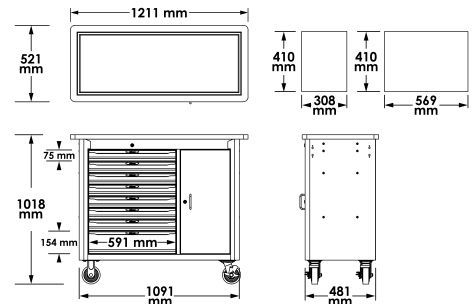

**+ assortment**

V6643N

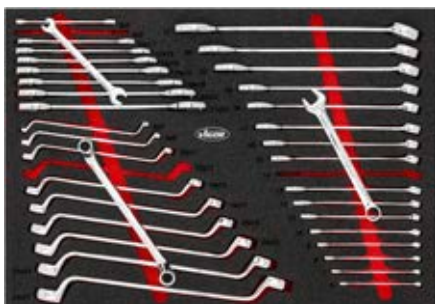

V4230



V4188



V5636N



# Mobile work bench with assortment



V5158, EAN 4047728051583



Mobile work bench with assortment and wooden board

• Delivery without pull-handle

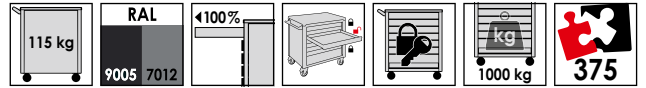

Drawer equipment variants:

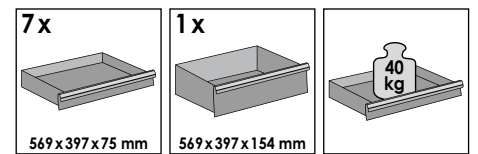
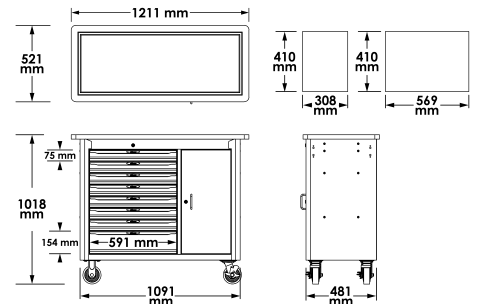

## + assortment

V4188



V4727

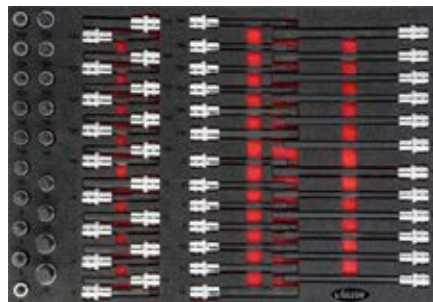

V4729



V6643N



V4230



V5636N



V5489, EAN 4047728054898

**VIGOR**  
SERIES **M**

Tool trolley without assortment, with foam mat

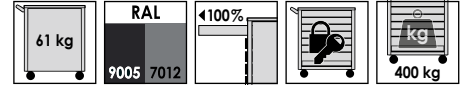

Drawer equipment variants:

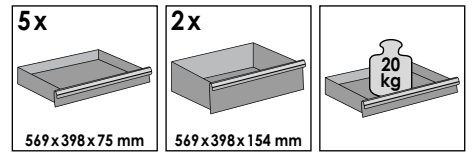
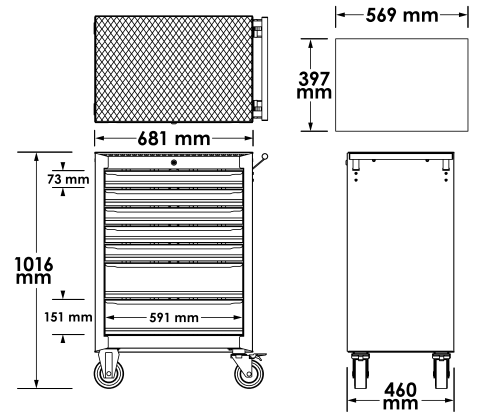

Would you like a customised insert?  
Create this with the insert KonVIGORator on our website.



# Tool trolleys without assortment



V1901, EAN 4047728019019



Tool trolley without assortment, with plastic worktop

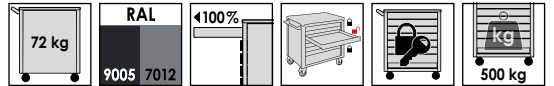

Drawer equipment variants:

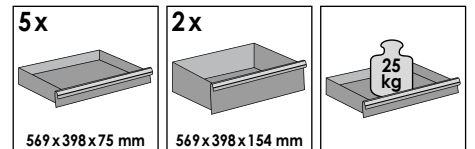
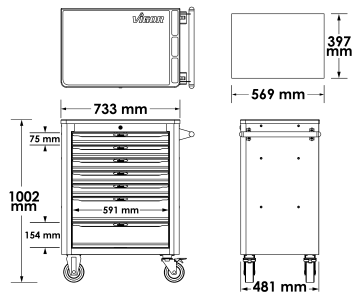

Would you like a customised insert? Create this with the insert KonVIGORator on our website.



V1902, EAN 4047728019026



Tool chest for tool trolley V1901

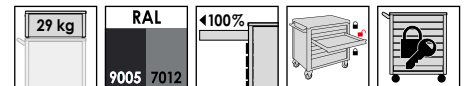

Drawer equipment variants:

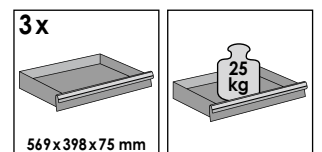
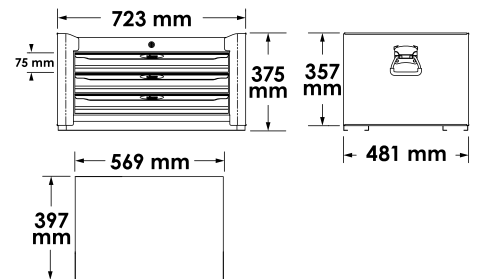

V1901-X, EAN 4047728083072

**VIGOR**  
SERIES **L**

Tool trolley without assortment,  
with stainless steel worktop

**NEW**

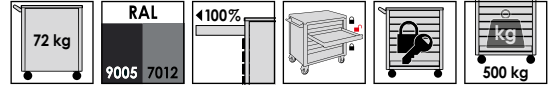

Drawer equipment variants:

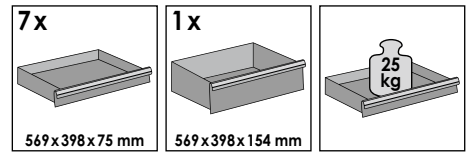
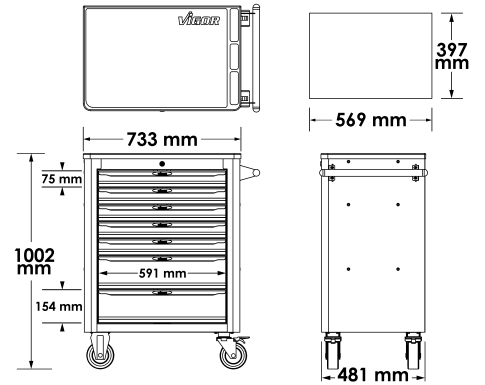

Would you like a  
customised insert?  
Create this with the  
insert KonVIGORator  
on our website.





# Tool trolleys without assortment



V1970, EAN 4047728019705



Tool trolley including tool chest without assortment, with plastic worktop

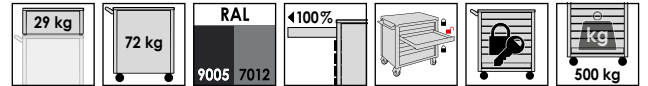

Drawer equipment variants:

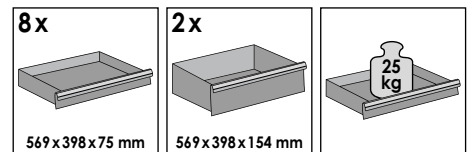
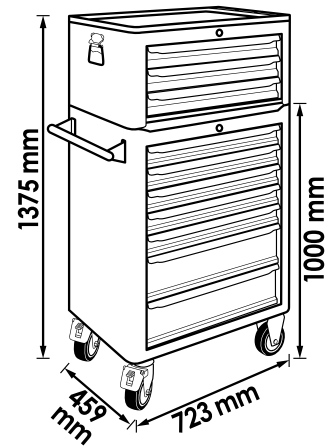

Would you like a customised insert? Create this with the insert KonVIGORator on our website.



V4481, EAN 4047728044813

**VIGOR**  
SERIES **XL**

Tool trolley without assortment, with plastic worktop

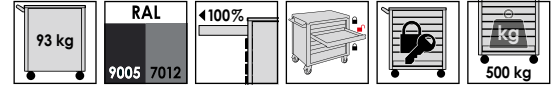

Drawer equipment variants:

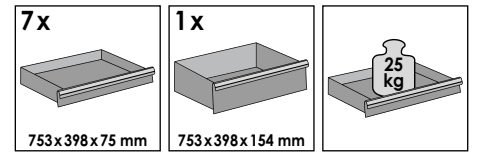
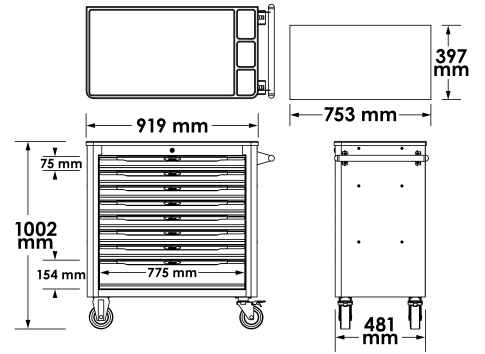

Would you like a customised insert?  
Create this with the insert KonVIGORator on our website.



# Tool trolleys without assortment



V4481-X, EAN 4047728060721



Tool trolley without assortment, with stainless steel worktop

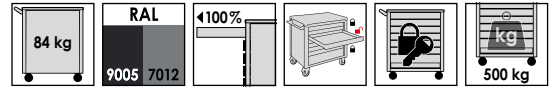

Drawer equipment variants:

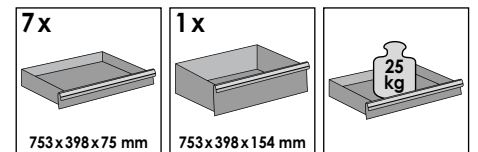
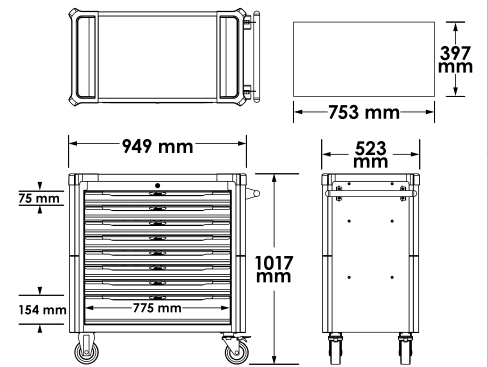

Would you like a customised insert? Create this with the insert KonVIGORator on our website.



V4481-XD, EAN 4047728066488

**VIGOR**  
SERIES **XD**

Extra-deep tool trolley without assortment, with stainless steel worktop

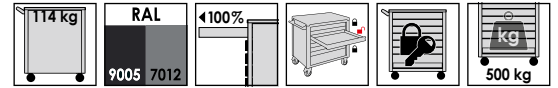

Drawer equipment variants:

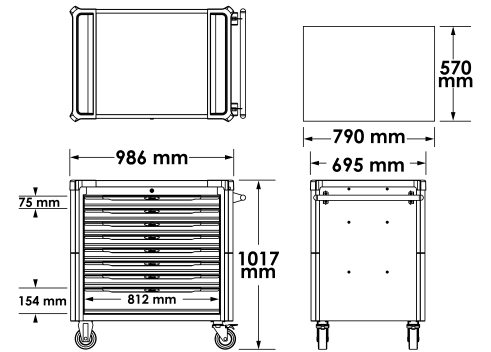

**V4481 - EXTRA DEEP**

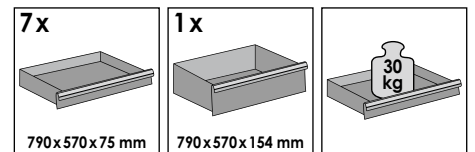

Would you like a customised insert?  
Create this with the insert KonVIGORator on our website.



# Mobile work bench without assortment



V4813, EAN 4047728048132



Mobile work bench without assortment, with wooden board

• Delivery without pull-handle

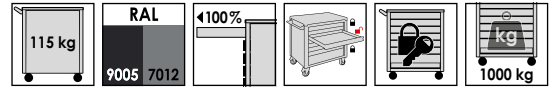

Drawer equipment variants:

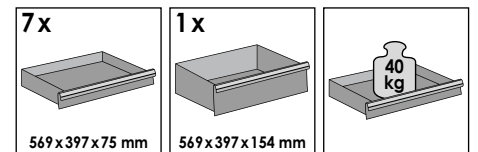
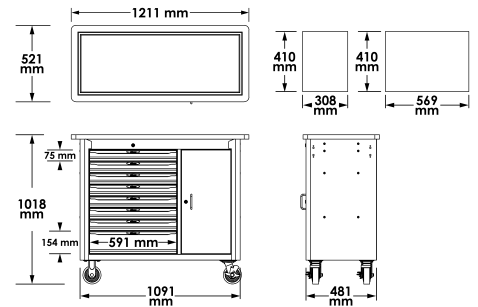

Would you like a customised insert? Create this with the insert KonVIGORator on our website.



V4814, EAN 4047728048149

**VIGOR**  
SERIES **XL**

Mobile work bench without assortment, with wooden board

• Delivery without pull-handle

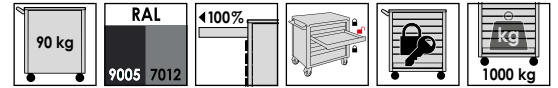

Drawer equipment variants:

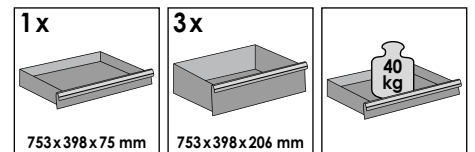
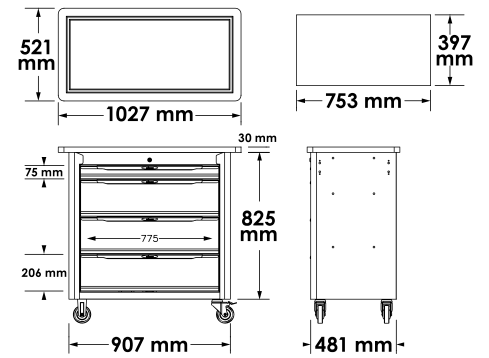

Would you like a customised insert? Create this with the insert KonVIGORator on our website.

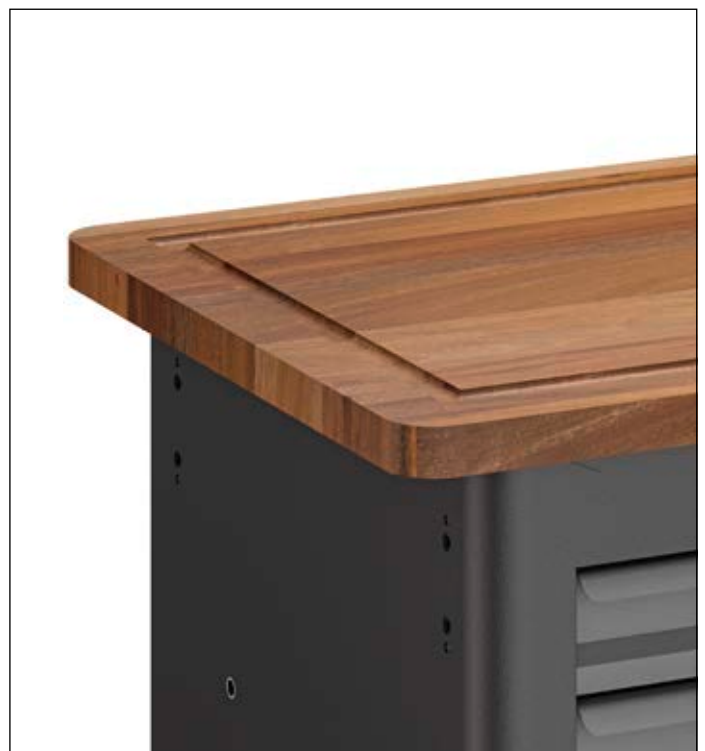

# Tool trolleys without assortment



V4481-XXL, EAN 4047728080491



Extra-deep, extra-wide tool trolley without assortment, with stainless steel worktop

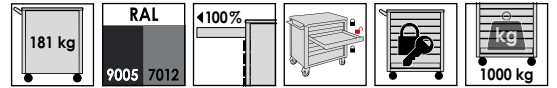

Drawer equipment variants:

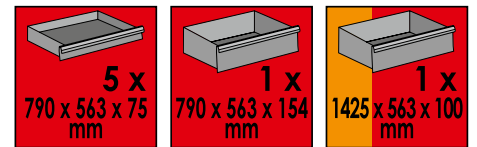
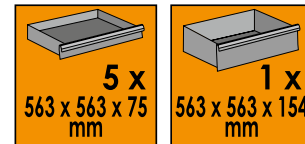
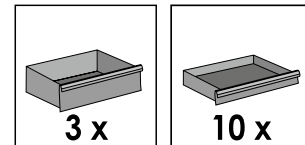

Would you like a customised insert? Create this with the insert KonVIGORator on our website.



**V4758**, EAN 4047728**047586**

## Service trolley

- Robust sheet-steel design (1 mm strong intermediate plates and 1.5 mm strong angle elements)
- Middle level adjustable in height by 30 mm in 7 stages, for containers, for example
- Loading capacity per tray: 40 kg
- Large ball-bearing wheels (Ø 100 mm), 2 swivel castors, 2 fixed castors
- Easy manoeuvrability, even with high dynamic load
- Sturdy handle, firmly attached to the trolley's corpus
- Weight: 19 kg

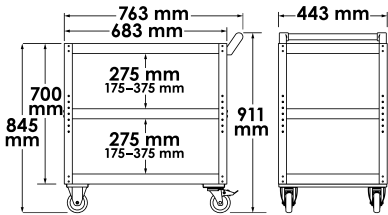

VIGOR No.	Designation		EAN 4047728+
V5180	Swivel castor (pair) · for service trolley V4758	2	051804
V5191	Fixed castor (pair) · for service trolley V4758	2	051910



**V6398**, EAN 4047728**071314**

## Laptop holder · rotatable and pivotable

- Suitable for all series since 07/2019 → (with four screw sleeves)
- Pivotable and lockable
- 360° rotation
- Frontal and lateral edging protects the device from falling
- The work surface can be adjusted to the desired inclination
- Four additional bore holes for passing cables

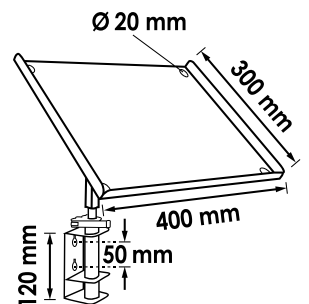



**V6221**, EAN 4047728062213

## Laptop table

- Additional storage space for laptops, tablets, tools or motor vehicle components
- Suitable for all series
- Can be expanded and collapsed when installed
- Expansion of the tool trolley surface for better organisation and overview while working
- Locking element prevents unintentional folding of the table
- Maximum permitted loading capacity: 25 kg



Screwed locking element

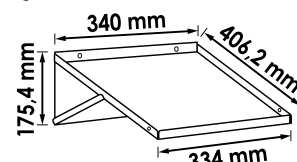

**V6395**, EAN 4047728070522

## Waste bin

- Disposal of waste or cloths
- Suitable for all series
- Also suitable for storing tools
- Capacity: 20 l

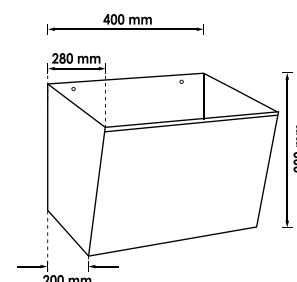

**V6396**, EAN 4047728069601

## Screwdriver holder

- Quick access to screwdrivers directly on the tool trolley
- Suitable for all series
- For 12 screwdrivers

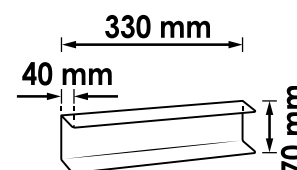

**V6394**, EAN 4047728069595

## Impact wrench holder

- Putting an impact wrench down directly on the tool trolley
- Suitable for all series since 07/2019→ (with four screw sleeves)
- Plastic edge protection prevents scratches when inserting the impact wrench
- Suitable for impact wrenches

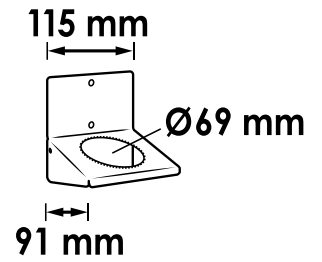

**V6689**, EAN 4047728079419

## Handle rail for tool trolley and VSS lower cabinets

- Replacement handle rail with Vigor logo
- Suitable for series L, series XL and series XD tool trolleys as well as all VSS lower cabinets



**V2397**, EAN 4047728023979

## Holder for paper reel

- Paper reels can be hung directly at the workplace
- Suitable for all series
- Paper reel not included
- Maximum width of paper reel: 370 mm

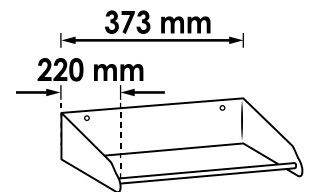

**V6397**, EAN 4047728069793

## Holder for paper reel · pivotable

- Paper reels can be hung directly at the workplace
- Suitable for all series
- Paper reel not included
- Maximum width of paper reel: 320 mm

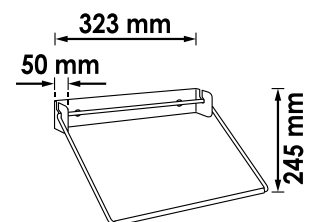

## Document holder

- Storing of clipboards or order pockets directly at the workstation
- Suitable for all series
- Optimum storage of documents or workshop documents directly at the workplace



VIGOR No.	Designation	LxWxH mm	EAN 4047728+
<b>V6393-S</b>	Document holder · small · floor depth 43 mm	340x70x156	<b>069205</b>
<b>V6393</b>	Document holder · large · floor depth 100 mm	340x146x176	<b>069519</b>

## Can holder

(without cans)



VIGOR No.	Designation	EAN 4047728+
<b>V2393</b>	Can holders · for series M · series L · series XL · series XD (except V4481-X) · up to 5 cans	<b>023931</b>
<b>V2393-S</b>	Can holder · short · for all series · up to 4 cans	<b>062046</b>
<b>V2393-XD</b>	Can holder · extra long · for series XD · up to 6 cans	<b>067614</b>

## Compartment for small pieces



VIGOR No.	Designation	EAN 4047728+
<b>V4481-X-4</b>	Compartment for small pieces · V4481-X	<b>073639</b>
<b>V4481-XD-4</b>	Compartment for small pieces · V4481-XD	<b>073646</b>



## Separation sheet set

- Sorting of small parts in tool trolleys or storage system lower cabinets
- All four divider plate sizes compatible with the separation sheet set
- Divider plates can be inserted into each other thanks to asymmetrical punching
- Hot-dip galvanized surface prevents rust formation

Asymmetrical punching allows the divider plates to be placed side-by-side within a row

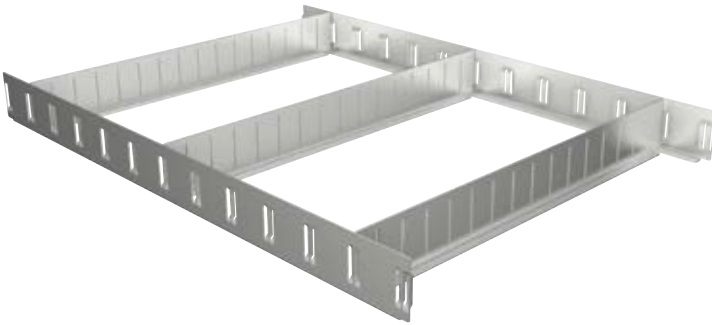

192 partitions possible

VIGOR No.	Designation		EAN 4047728+
V6688	Separation sheet set, series M and series L	5	070249
V6688-XL	Separation sheet set, series XL	6	070096
V6688-XD	Separation sheet set, series XD	6	070089
V6688H	Separation sheet set, high, series M and series L	5	080958
V6688H-XD	Separation sheet set, high, series XD	5	081009
V6688H-XL	Separation sheet set, high, series XL	5	081580

## Divider plate set

- Compatible with all separation sheet sets and cross members
- For partitioning within a column

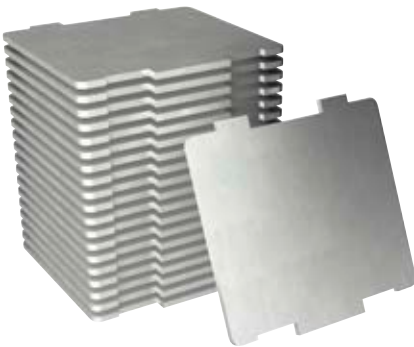

4 different divider plate lengths – can be used for all systems



VIGOR No.	Designation		EAN 4047728+
V6685-1/20	Divider plate set · small 45 mm	20	070133
V6685-2/20	Divider plate set · medium 91 mm	20	070126
V6685-3/10	Divider plate set · large 137 mm	10	070119
V6685-4/10	Divider plate set · extra large 183 mm	10	070102
V6685H-2/20	High divider plate set · medium 91 mm	20	080989
V6685H-3/10	High divider plate set · large 137 mm	10	081511
V6685H-4/10	High divider plate set · extra large 183 mm	10	080996

## Cross member set

- Hot-dip galvanized surface prevents rust formation



More stability and hold thanks to splayed edges



VIGOR No.	Designation		EAN 4047728+
V6687/5	Cross member set for series XD	5	070072
V6686/5	Cross member set for series M · series L and series XL	5	070065
V6685H/5	High cross member set for series M · series L and series XL	5	080972
V6687H/5	Cross member set for series XD	5	080965

## Fixed castor

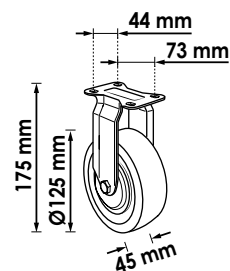

VIGOR No.	Designation	XX	EAN 4047728+
V1907	Fixed castor · for tool trolleys series M · series L · series XL · series XD	1	019071
V4814-3	Fixed castor (pair) · for tool trolleys series XL · series XL Special and work benches	2	053044
V5191	Fixed castor (pair) · for service trolley V4758	2	051910

## Swivel castor with locking brake

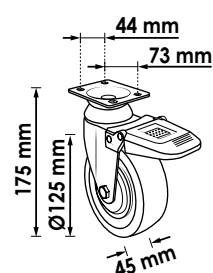

VIGOR No.	Designation	XX	EAN 4047728+
V1908	Swivel castor · for tool trolleys series M · series L · series XL · series XD	1	019088
V4814-2	Swivel castor (pair) · for tool trolleys series XL · series XL Special and work benches	2	053037
V5180	Swivel castor (pair) · for service trolley V4758	2	051804

## Drawer · flat



Including rails



VIGOR No.	Designation	LxWxH mm	EAN 4047728+
V5489-4	Drawer · flat · 569x398x75 mm · for series M	589x398x75	055413
V1905	Drawer · flat · 569x398x75 mm · for series L · V1901 · V1902 · work bench V4813	589x398x75	019057
V4112	Drawer · flat · 753x398x75 mm · for series XL · series XL Special	753x398x75	041126
V4481-XD-2	Drawer · flat · for series XD	790x570x75	067812

## Drawer · high



Including rails



VIGOR No.	Designation	LxWxH mm	EAN 4047728+
V5489-3	Drawer · high · 569x398x154 mm · for series M	589x398x154	055307
V1906	Drawer · high · 569x398x154 mm · for series L · V1901 · work bench V4813	569x398x154	019064
V4111	Drawer · high · 753x398x154 mm · for series XL	753x398x154	041119
V4814-1	Drawer · high · 741x397x206 mm · for series XL Special	741x397x206	053020
V4481-XD-3	Drawer · high · for series XD	790x570x154	067829

## Locking system



VIGOR No.	Designation	EAN 4047728+
<b>V2462</b>	Spare lock for all VIGOR tool trolleys and work benches	<b>024624</b>
<b>V1904</b>	Locking system for all VIGOR tool trolleys and work benches	<b>019040</b>

## Guiding rails (pair)



VIGOR No.	Designation	XX	EAN 4047728+
<b>V5489-1</b>	Guiding rails (pair) · for series M	2	<b>055284</b>
<b>V1903</b>	Guiding rails (pair) · for series L · series XL	2	<b>019033</b>
<b>V4481-XD-1</b>	Guiding rails (pair) · for series XD	2	<b>067805</b>

## Worktop · plastic



VIGOR No.	Designation	EAN 4047728+
<b>V1909</b>	Worktop 723x459 mm · plastic · for tool trolley and tool chest series L	<b>019095</b>
<b>V4122</b>	Worktop 907x481 mm · plastic · for tool trolley series XL	<b>041225</b>

## Worktop · wood



VIGOR No.	Designation	EAN 4047728+
<b>V4814-4</b>	Worktop 1030x520 mm · wood · for mobile work bench series XL	<b>053051</b>
<b>V4813-1</b>	Worktop 1201x520 mm · wood · for tool trolley series L	<b>053013</b>

**V5489-2**, EAN 4047728**055291**

**Foam mat**

- For tool trolley series M
- LxW: 670x450 mm



**V4813-2**, EAN 4047728**059268**

**Storage shelf**

- For work bench VIGOR V4813
- LxW: 400x450 mm



**V5489-5**, EAN 4047728**075626**

**Pull-handle**

- Easy manoeuvring of tool trolleys and work benches
- Handle · for tool trolleys · series M



**V4893**, EAN 4047728**048934**

**Pull-handle**

- Easy manoeuvring of tool trolleys and work benches
- Handle · for tool trolleys · series L and series XL



**V4481-X-5**, EAN 4047728**075619**

**Pull-handle**

- Easy manoeuvring of tool trolleys
- Handle · for tool trolleys · series XL · stainless steel



**V4481-XD-5**, EAN 4047728**075602**

**Pull-handle**

- Easy manoeuvring of tool trolleys
- Handle · for tool trolleys · series XD



**NEW**

## Perforated tool panel plate for tool trolleys

- Flexible, customised arrangement of tools and accessories by using tool hooks, holders, etc.
- Attachment via existing screw sleeves

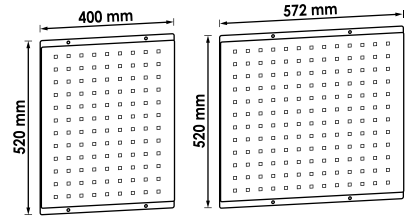
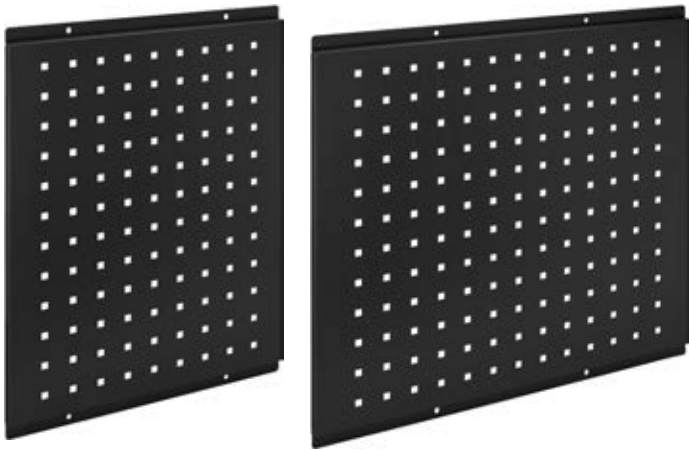

VIGOR No.	Designation	EAN 4047728+
V6399	Perforated tool panel plate for tool trolleys - series L and XL	085533
V6399-XD	Perforated tool panel plate for tool trolleys - series XD and XXL	085540

## Tool hook set

- Hanging of tools
- Use with tool cabinet V2532 and perforated tool panel plates V6000-05 · V6000-015



**V2517**   25   **025171**



**V2518**   100   **025188**



**V2519**   25   **025195**



**V2520**   100   **025201**





**V6150N**, EAN 4047728**084734**

## Vice

- Rotatable in horizontal and vertical axis
- Collet chucks for flat and round parts (drive shafts, steering tie rods, etc.)
- Flexible working from different angles
- Quick and easy adjustment of the working position
- Scales for clamping length (mm) and clamping angle (°)
- Hardened gripping jaws for maximum durability
- 125 mm collet chuck
- 130 mm max. span width

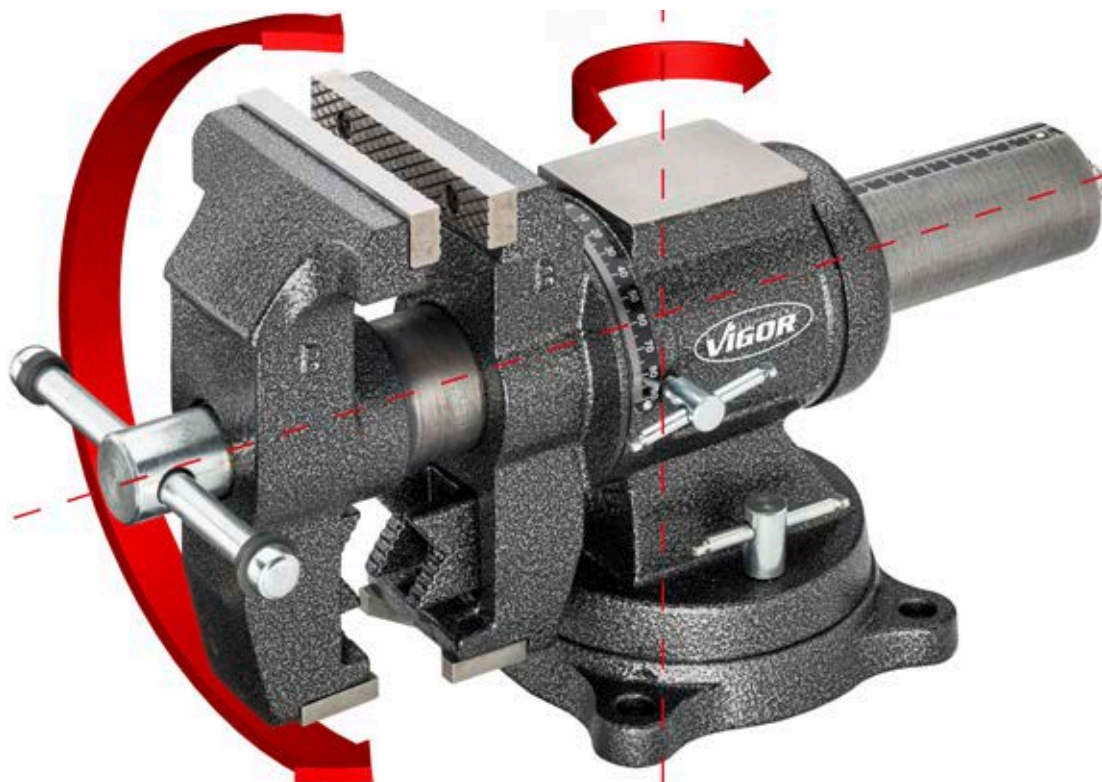
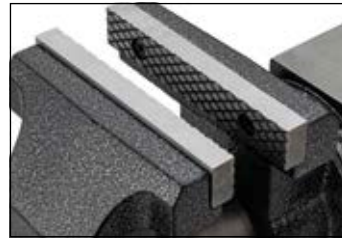

**NEW**



No more misplaced keys and unnecessary interruptions! We're now introducing a small but effective upgrade for our VIGOR storage system: the classic cylinder lock with key has had its day and is being replaced by a modern combination lock.

## The benefits for you:

- **Quick and easy access:**

No more searching for the right key – simply enter the code and get started.

- **Greater security:**

A user-defined code enhances protection against unauthorised access and can be changed at any time.

- **Flexibility in daily work:**

Ideal for teams – no more key management or changing locks, each station has its own locking code.

- **Maximum security:**

In an emergency, you can open the lock with a key and reset the locking code.

- **Robust and durable:**

Our combination locks are specially designed for demanding everyday workshop use and can withstand even heavy loads.

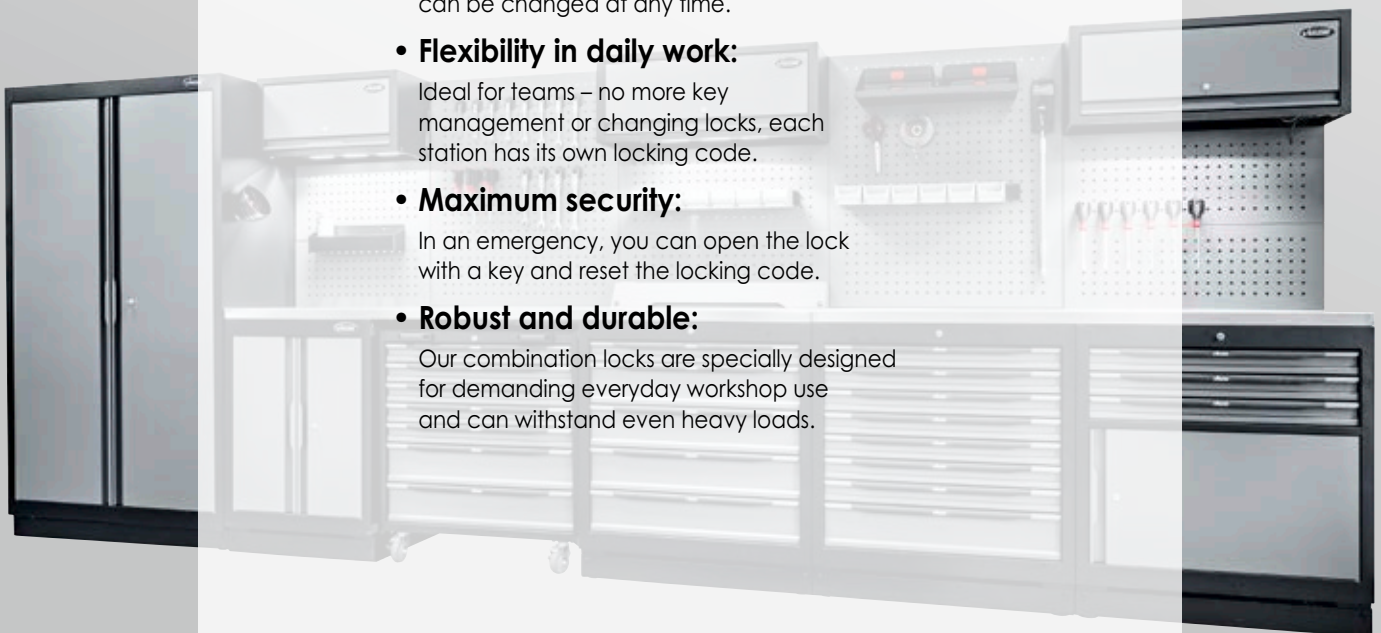

# Storage system

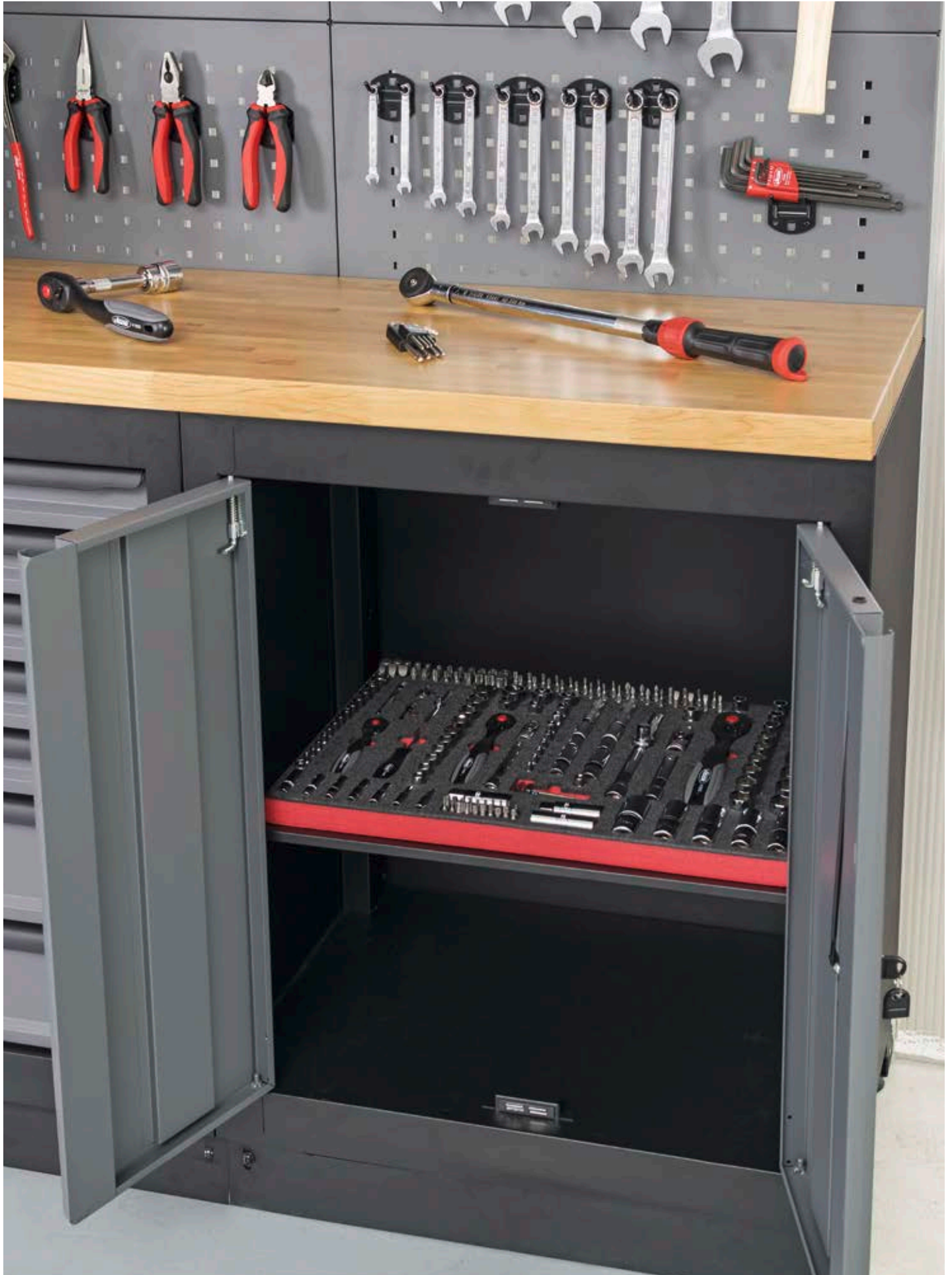

[www.vigor-equipment.com/konfigurator](http://www.vigor-equipment.com/konfigurator)

## KONVIGORATOR



### Technical information



Insert dimensions narrow  
563x393 mm



Insert dimensions wide  
750x393 mm



RAL colours 9005 ·  
similar to 7012



Feet adjustable in  
height to 50 mm



The installation material is  
included in delivery



Central locking

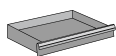

Narrow and flat drawer dimensions:  
569x398x75 mm

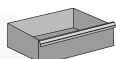

Narrow and high drawer dimensions:  
569x398x154 mm



Loading capacity of drawer: 25 kg

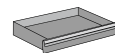

Wide and flat drawer dimensions:  
753x398x75 mm



Wide and high drawer dimensions:  
753x398x154 mm

# Storage system



## V6000-3P1

### Storage system

- 3-module combination in wide design
- Available with wooden or stainless steel worktop
- Including side veneer

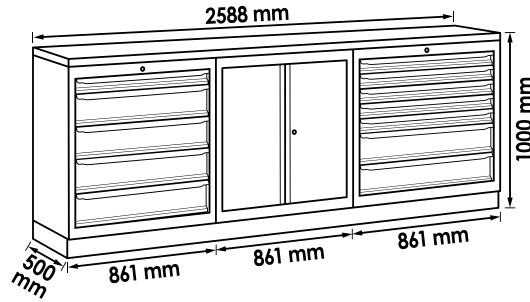

**XL**

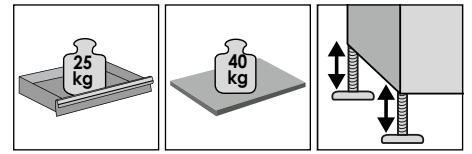

## Starter kit



VIGOR No.	Designation	LxWxH mm	EAN 4047728+
V6000-3P1XL-X	Storage system combination · starter kit · stainless steel	2588 x 500 x 1000	073271
V6000-3P1XL	Storage system combination · starter kit · wooden	2588 x 500 x 1000	073318

*All kits available with stainless steel or wooden worktops*



## V6000-3P2

### Storage system

- 3-module combination in wide design with perforated panel structure and wall cabinets
- Available with wooden or stainless steel worktop
- Including side veneer

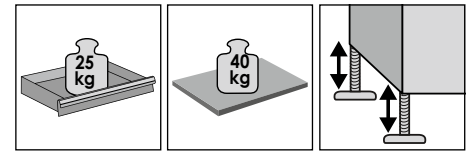
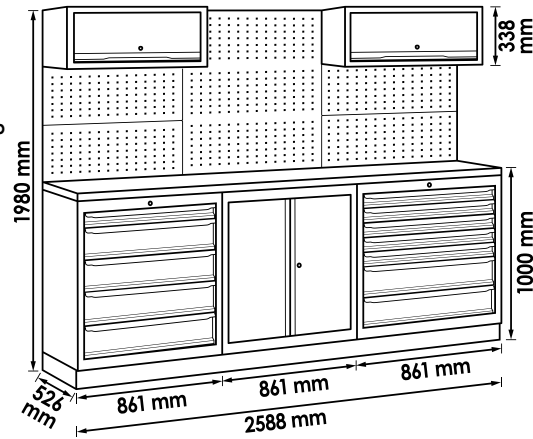

## Complete kit



VIGOR No.	Designation	LxWxH mm	EAN 4047728+
V6000-3P2XL	Storage system combination · complete kit · wooden	2588x526x1980	073301
V6000-3P2XL-X	Storage system combination · complete kit · stainless steel	2588x526x1980	073295

## V6000-3

### Storage system

- Cabinet door can be fitted on the right and left
- Cabinet door with magnetic lock
- Height-adjustable storage compartment
- All doors reinforced in the centre
- Simultaneous locking (equivalent to the series L locking system)
- Drawer dimensions same as for series L (569 x 398 x 75 mm flat drawer, 569 x 398 x 154 mm high drawer)
- Wall cabinets including high-quality shock absorbers
- Perforated tool panel for VIGOR tool hook sets V2517 · V2518 · V2519 · V2520

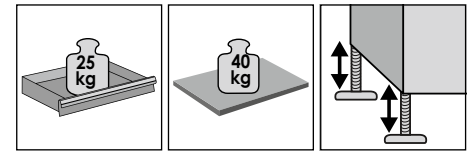
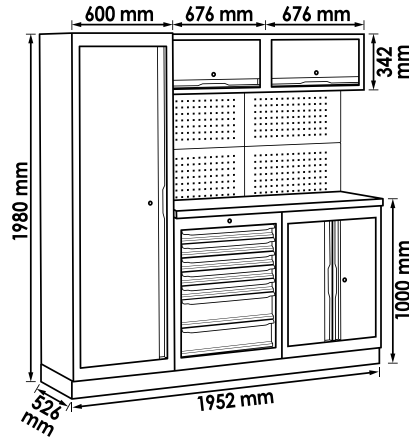

## Compact kit



VIGOR No.	Designation	EAN
V6000-3	Storage system combination · compact kit · wooden	4047728+ 048729
V6000-3-X	Storage system combination · compact kit · stainless steel	073288

**V6000-029**, EAN 4047728**076975**

## Drawer lower cabinet · 2 drawers

- Setting up a stationary workstation
- Tidy storage of tool boxes and specialty tool cases
- Similar to series L
- Upper drawer (HxWxD): 312x569x397 mm
- Lower drawer (HxWxD): 391x569x397 mm

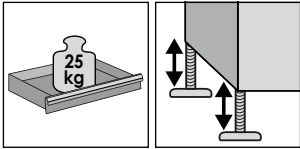
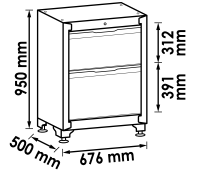

**V6000-029XL**, EAN 4047728**076982**

## Drawer lower cabinet · 2 drawers

- Setting up a stationary workstation
- Tidy storage of tool boxes and specialty tool cases
- Similar to series XL
- Upper drawer (HxWxD): 312x753x397 mm
- Lower drawer (HxWxD): 391x753x397 mm

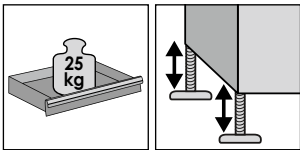
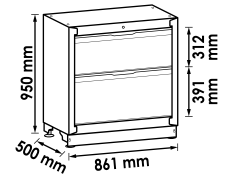

**V6000-030**, EAN 4047728**070140**

## Drawer lower cabinet · 3 drawers

- Setting up a stationary workstation
- Clean storage of tools, small parts or various consumables
- To save space and for tidy organisation, we recommend VIGOR separation sheets or soft foam inserts
- Similar to series L
- Dimensions (HxWxD)  
1st - 3rd drawer: 75x569x398 mm

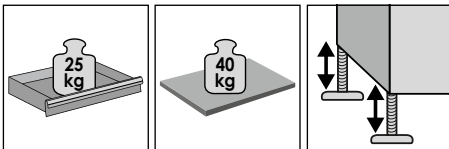
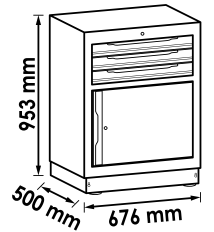

**V6000-030XL**, EAN 4047728**070294**

## Drawer lower cabinet · 3 drawers

- Setting up a stationary workstation
- Clean storage of tools, small parts or various consumables
- To save space and for tidy organisation, we recommend VIGOR separation sheets or soft foam inserts
- Similar to series XL
- Dimensions (HxWxD)  
1st - 3rd drawer: 75x753x398 mm

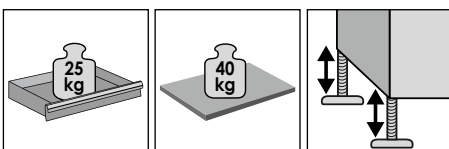
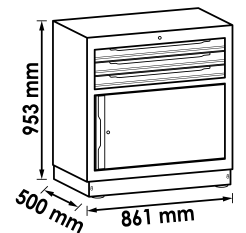



# Storage system



**V6000-031**, EAN 4047728**070157**

## Drawer lower cabinet · 5 drawers

- Setting up a stationary workstation
- Clean storage of tools, small parts or various consumables
- To save space and for tidy organisation, we recommend VIGOR separation sheets or soft foam inserts
- Similar to series L
- Dimensions (HxWxD)  
1st drawer: 75 x 569 x 398 mm  
2nd – 5th drawer: 154 x 569 x 398 mm

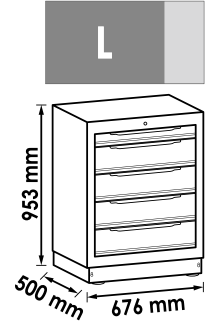
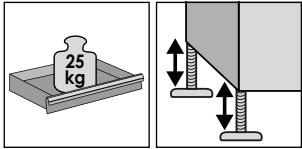

**V6000-031XL**, EAN 4047728**070300**

## Drawer lower cabinet · 5 drawers

- Setting up a stationary workstation
- Clean storage of tools, small parts or various consumables
- To save space and for tidy organisation, we recommend VIGOR separation sheets or soft foam inserts
- Similar to series XL
- Dimensions (HxWxD)  
1st drawer: 75 x 753 x 398 mm  
2nd – 5th drawer: 154 x 753 x 398 mm

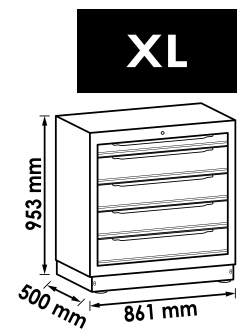
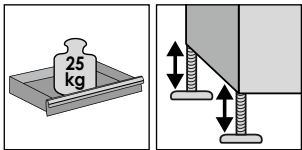

**V6000-031XD**, EAN 4047728**081184**

## Drawer lower cabinet · extra deep · 5 drawers

- Setting up a stationary workstation
- Clean storage of tools, small parts or various consumables
- To save space and for tidy organisation, we recommend VIGOR separation sheets or soft foam inserts
- Similar to series XD
- Dimensions (HxWxD)  
1st drawer: 75 x 790 x 570 mm  
2nd – 5th drawer: 154 x 790 x 570 mm

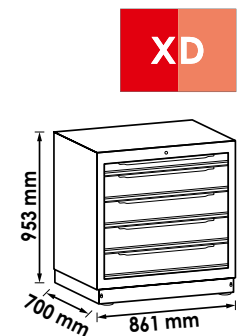
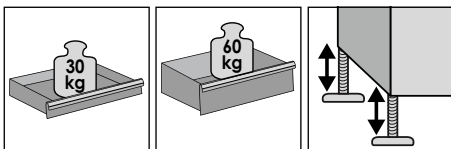

## V6000-01, EAN 4047728048248

### Drawer lower cabinet · 7 drawers

- Setting up a stationary workstation
- Clean storage of tools, small parts or various consumables
- To save space and for tidy organisation, we recommend VIGOR separation sheets or soft foam inserts
- Similar to series L
- Dimensions (HxWxD)  
1st - 5th drawer: 75x569x398 mm  
6th - 7th drawer: 154x569x398 mm

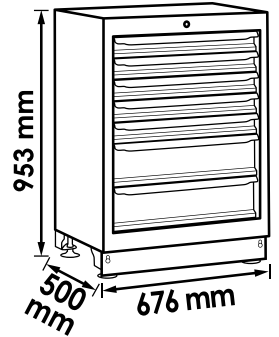
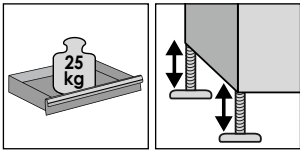

## V6000-01XL, EAN 4047728070317

### Drawer lower cabinet · 7 drawers

- Setting up a stationary workstation
- Clean storage of tools, small parts or various consumables
- To save space and for tidy organisation, we recommend VIGOR separation sheets or soft foam inserts
- Similar to series XL
- Dimensions (HxWxD)  
1st - 5th drawer: 75x753x398 mm  
6th - 7th drawer: 154x753x398 mm

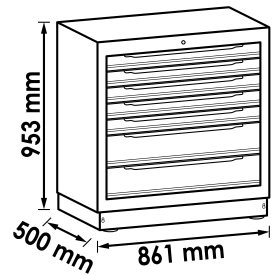
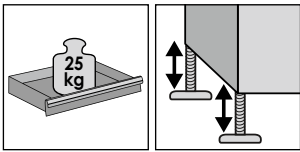

## V6000-01XD, EAN 4047728081016

### Drawer lower cabinet · extra deep · 7 drawers

- Setting up a stationary workstation
- Clean storage of tools, small parts or various consumables
- To save space and for tidy organisation, we recommend VIGOR separation sheets or soft foam inserts
- Similar to series XD
- Dimensions (HxWxD)  
1st - 5th drawer: 75x790x570 mm  
6th - 7th drawer: 154x790x570 mm

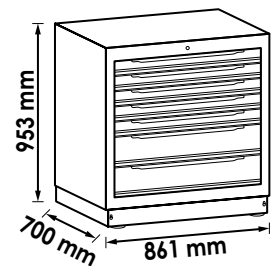
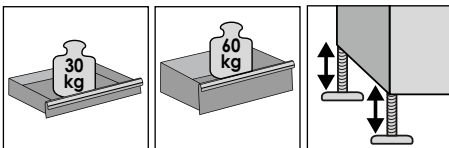

# Storage system



**V6000-019**, EAN 4047728**063883**

## Tool trolley for storage system · 7 drawers

- Space-saving storage of a tool trolley under the storage system worktop
- Especially for VIGOR storage system
- 4 swivel castors and special height for space-saving storage of the tool trolley after use under the storage system worktop
- Similar to series L
- Dimensions (HxWxD)  
1st - 5th drawer: 75x569x398 mm  
6th - 7th drawer: 154x569x398 mm

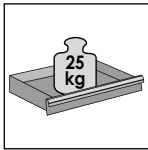

With 4 swivel castors

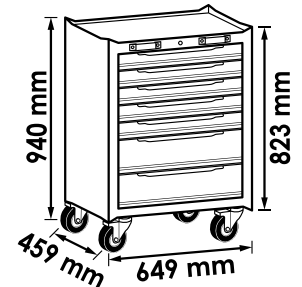

**V6000-019XL**, EAN 4047728**070683**

## Tool trolley for storage system · 7 drawers

- Space-saving storage of a tool trolley under the storage system worktop
- Especially for VIGOR storage system
- 4 swivel castors and special height for space-saving storage of the tool trolley after use under the storage system worktop
- Similar to series XL
- Dimensions (HxWxD)  
1st - 5th drawer: 75x753x398 mm  
6th - 7th drawer: 154x753x398 mm

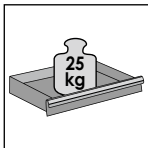

With 4 swivel castors

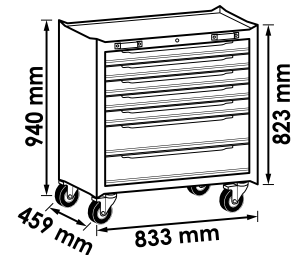

**V6000-032**, EAN 4047728**070171**

## Drawer lower cabinet · 8 drawers

- Setting up a stationary workstation
- Clean storage of tools, small parts or various consumables
- To save space and for tidy organisation, we recommend VIGOR separation sheets or soft foam inserts
- Similar to series L
- Dimensions (HxWxD)  
1st - 7th drawer: 75x569x398 mm  
8th drawer: 154x569x398 mm

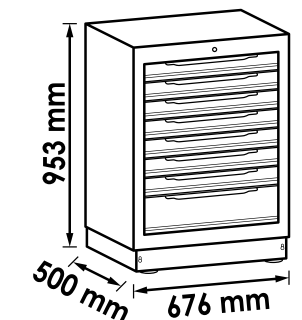
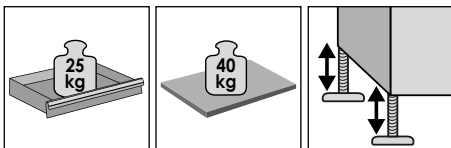

**V6000-032XL**, EAN 4047728070324

## Drawer lower cabinet · 8 drawers

- Setting up a stationary workstation
- Clean storage of tools, small parts or various consumables
- To save space and for tidy organisation, we recommend VIGOR separation sheets or soft foam inserts
- Similar to series XL
- Dimensions (HxWxD)  
1st - 7th drawer: 75x753x398 mm  
8th drawer: 154x753x398 mm



**XL**

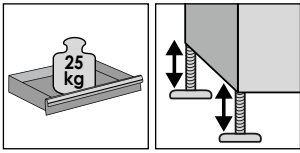
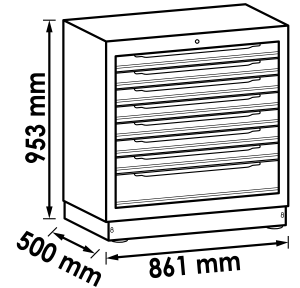

**V6000-033**, EAN 4047728070195

## Lower cabinet for waste

- Setting up a stationary workstation
- Waste separation directly at the workstation
- Waste bin securely and neatly positioned in the wall unit module
- Lower cabinet with flap for rapid waste disposal
- Delivery including two waste bins
- Capacity of the waste bin: 35 l
- Similar to series L



+



**L**

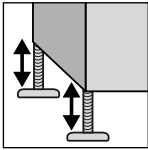
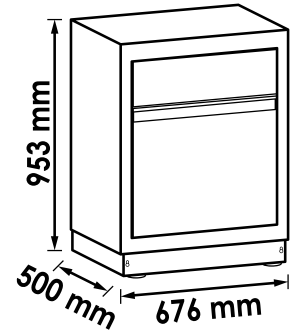

**V6000-033XL**, EAN 4047728070331

## Lower cabinet for waste

- Setting up a stationary workstation
- Waste separation directly at the workstation
- Waste bin securely and neatly positioned in the wall unit module
- Lower cabinet with flap for rapid waste disposal
- Delivery including three waste bins
- Capacity of the waste bin: 1x25 l · 2x35 l
- Similar to series XL



+



**XL**

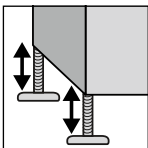
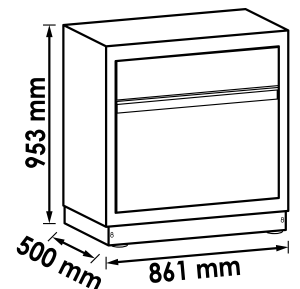

**V6000-035**, EAN 4047728**074582**

## Multipurpose lower cabinet

- Setting up a stationary workstation
- Waste bin (35 l) with access flap for quick waste disposal
- Paper reel holder
- Drawer (loading capacity 25 kg) for stowing tools, small parts and various consumables
- Drawer dimensions:
  - Left: W 288 x D 397 x H 707 mm
  - Right: W 260 x D 397 x H 340 mm

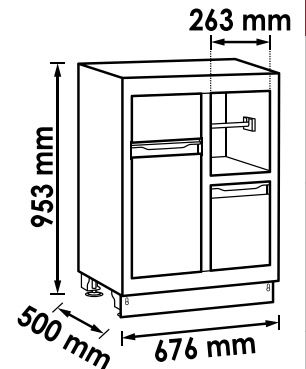
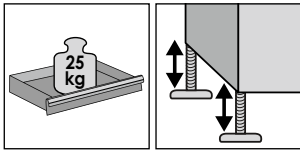

**V6000-035XL**, EAN 4047728**074599**

## Multipurpose lower cabinet

- Setting up a stationary workstation
- Waste bin (35 l) with access flap for quick waste disposal
- Paper reel holder
- Drawer (loading capacity 25 kg) for stowing tools, small parts and various consumables
- Drawer dimensions:
  - Left: W 268 x D 397 x H 707 mm
  - Right: W 471 x D 397 x H 340 mm

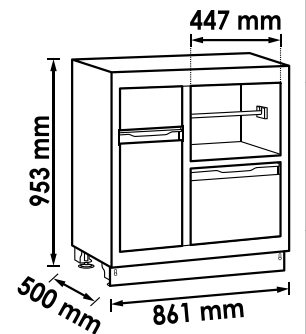
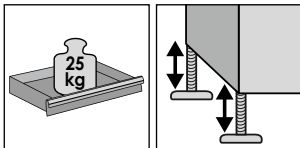

**V6000-02**, EAN 4047728**048255**

## Lower cabinet with double-hinged door

- Setting up a stationary workstation
- Storage of tool boxes, work clothes, containers or motor vehicle parts
- Hinged-door with magnetic lock
- Height-adjustable storage compartment
- Inside dimensions (L x W x H): 561 x 466.4 x 561 mm
- Can be extended with additional V6000-018 storage shelves
- Similar to series L

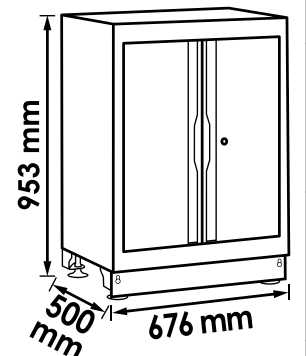
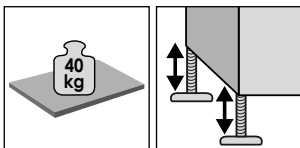

**V6000-02XL**, EAN 4047728070355

**Lower cabinet with double-hinged door**

- Setting up a stationary workstation
- Storage of tool boxes, work clothes, containers or motor vehicle parts
- Hinged-door with magnetic lock
- Height-adjustable storage compartment
- Inside dimensions (LxWxH): 561 x 466.4 x 561 mm
- Can be extended with additional V6000-018XL storage shelves
- Similar to series XL

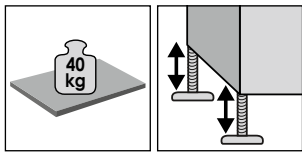
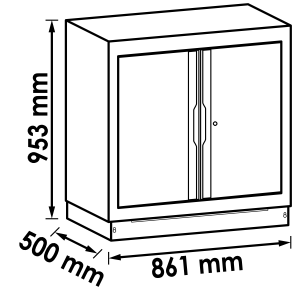

**V6000-02XD**, EAN 4047728081191

**Lower cabinet with double-hinged door · extra deep**

- Setting up a stationary workstation
- Storage of tool boxes, work clothes, containers or motor vehicle parts
- Hinged-door with magnetic lock
- Height-adjustable storage compartment
- Can be retrofitted into existing systems
- Similar to series XD
- Inside dimensions: 787 x 649 x 690 mm (W x D x H)

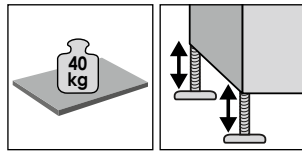
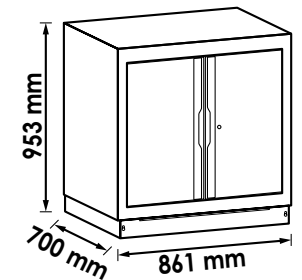

**V6000-011**, EAN 4047728054904

**Corner base cabinet**

- Corner extension for additional lower cabinets
- For corner extension of the storage system line
- Including storage shelf

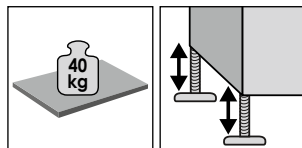
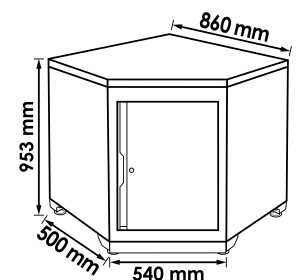

# Storage system



**V6000-058**, EAN 4047728**083416**

## Corner wall cabinet

- Can be retrofitted into existing systems
- For 500 mm deep corner configurations
- Optimal storage of tools or consumables

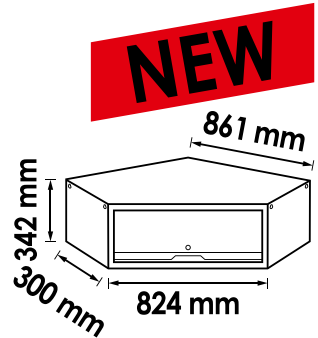

**V6000-056XL**, EAN 4047728**084215**

## Refrigerator · integrable

Put the finishing touches to your storage system!

The V6000-056XL refrigerator, which can be integrated into the storage system, is not only a practical eye-catcher, but also a statement of style and elegance.

The benefits for you:

- Modern and elegant design that adds a luxurious touch to any workshop.
- Generous capacity: space for up to 220 330 ml beverage cans (186 litres total volume)
- Intelligent functions: the digital display lets you set the temperature in the range 0 – 10° C. The LED lighting can be switched off.
- Simple installation: thanks to the base frame supplied, the refrigerator can be easily installed in the storage system.

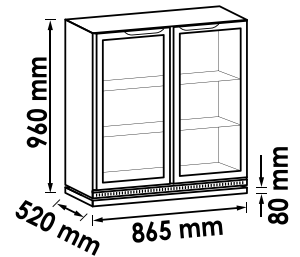
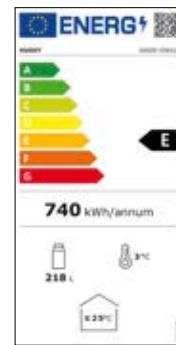

**V6000-037**, EAN 4047728**075015**

## Bridge-type lower cabinet

- Easy bridging of worktops – combines optimally with 500 mm deep worktops
- Creates much more workplace seating options and more storage space in your workshop
- A high drawer and a large storage compartment for stowing the tools
- Loading capacity of drawer: 25 kg
- 4 feet adjustable in height (up to 50 mm)

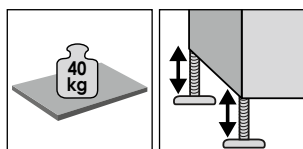
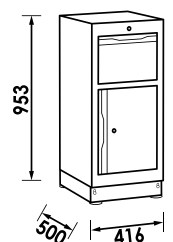

**V6000-03**, EAN 4047728**048262**

**Cabinet with single-hinged door · high**

- Storage of tool boxes, work clothes, containers or motor vehicle parts
- Cabinet door with magnetic lock
- Cabinet door can be fitted on the right and left
- Height-adjustable storage compartment
- Inside dimensions (LxWxH): 484x478x1503.3 / 220.5 mm
- Can be extended with V6000-017 storage shelves

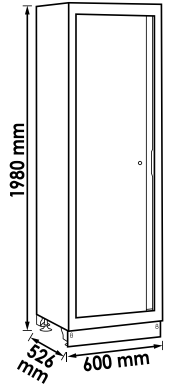
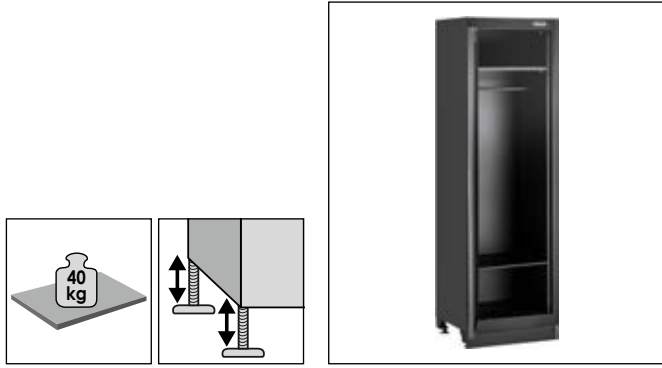

**V6000-03XL**, EAN 4047728**070362**

**Cabinet with double-hinged door · high**

- Storage of tool boxes, work clothes, containers or motor vehicle parts
- Cabinet door with magnetic lock
- Cabinet door can be fitted on the right and left
- Height-adjustable storage compartment
- Inside dimensions (LxWxH): 1119x510x1812 / 220.5 mm
- Can be extended with V6000-017XL storage shelves

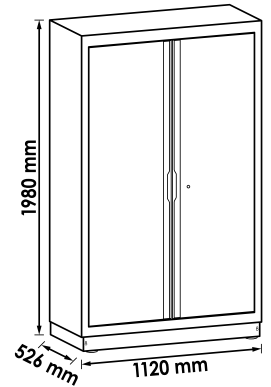
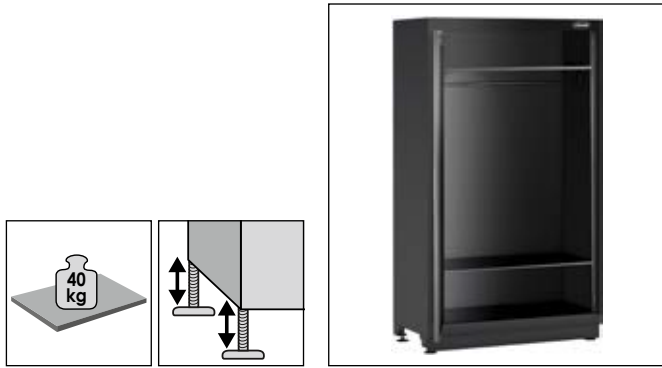

**V6000-03D**, EAN 4047728**084369**

**Cabinet with single-hinged door · high · extra deep**

- Storage of tool boxes, work clothes, containers or motor vehicle parts
- Cabinet door with magnetic lock
- Cabinet door can be fitted on the right and left
- Height-adjustable storage compartment
- Inside dimensions (LxW): 526 x 677 mm

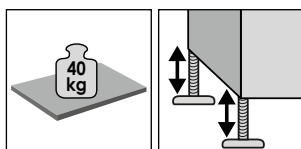

**NEW**





# Storage system



**V6000-03XD**, EAN 4047728**084352**

**Cabinet with double-hinged door · high · extra deep**

- Storage of tool boxes, work clothes, containers or motor vehicle parts
- Cabinet door with magnetic lock
- Cabinet door can be fitted on the right and left
- Height-adjustable storage compartment
- Inside dimensions (LxW): 1047 x 677 mm

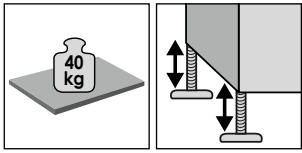

**NEW**



**V6000-04**, EAN 4047728**048279**

**Wall cabinet**

- Storage of tools, containers or motor vehicle parts

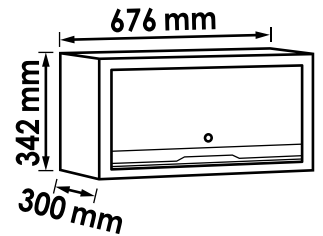

**V6000-04XL**, EAN 4047728**070379**

**Wall cabinet**

- Storage of tools, containers or motor vehicle parts

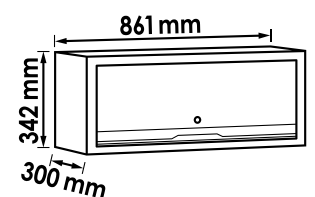

**V6000-046**, EAN 4047728**073615**

### Double hinged-door wall cabinet

- Combines optimally with 700 mm deep worktops
- Including 1 storage shelf adjustable in height
- Loading capacity of storage shelf: 15 kg
- Loading capacity of shelf base: 20 kg
- Hinged-door can be rotated to left or right hand stop
- Doors with magnetic lock

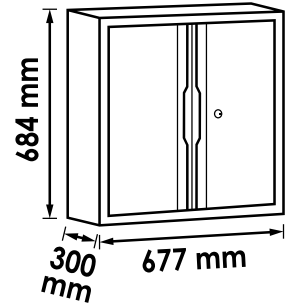

**V6000-046XL**, EAN 4047728**073622**

### Double hinged-door wall cabinet

- Combines optimally with 700 mm deep worktops
- Including 1 storage shelf adjustable in height
- Loading capacity of storage shelf: 15 kg
- Loading capacity of shelf base: 20 kg
- Hinged-door can be rotated to left or right hand stop
- Doors with magnetic lock

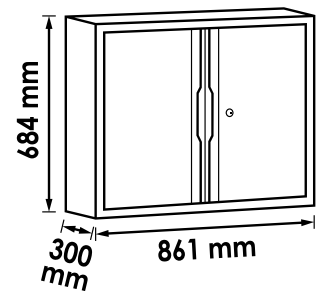

### Screw jacks

- Adjustable height
- Privacy panel included in delivery

*Perforated wall construction with supporting feet also possible*



VIGOR No.	Designation	LxWxH mm	EAN 4047728+
<b>V6000-044</b>	Screw jacks	104x500x953	<b>073325</b>
<b>V6000-044XL</b>	Screw jacks	104x700x953	<b>073370</b>

# Storage system



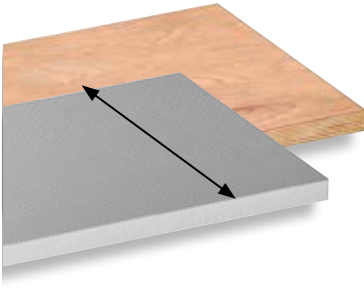

# 500mm



## Wooden worktop

• Fixation on storage system lower cabinets



VIGOR No.	Designation	LxWxH mm	EAN 4047728+
V6000-0676	Wooden worktop · small	676 x 500 x 40	073028
V6000-0861	Wooden worktop · small	861 x 500 x 40	073042
V6000-01541	Wooden worktop combined · medium	1541 x 500 x 40	073141
V6000-01357	Wooden worktop · medium	1357 x 500 x 40	073066
V6000-01725	Wooden worktop · medium	1725 x 500 x 40	073080
V6000-02036	Wooden worktop · large	2036 x 500 x 40	073103
V6000-02215	Wooden worktop combined · large	2215 x 500 x 40	073165
V6000-02404	Wooden worktop combined · large	2404 x 500 x 40	073189
V6000-02588	Wooden worktop · large	2588 x 500 x 40	073127



## Wooden worktop

VIGOR No.	Designation	LxWxH mm	EAN 4047728+
V6000-0860	Wooden worktop · pentagonal	883 x 500 x 40	073202



## Stainless steel worktop

• Fixation on storage system lower cabinets

VIGOR No.	Designation	LxWxH mm	EAN 4047728+
V6000-0676-X	Stainless steel worktop · small	676 x 500 x 40	073035
V6000-0861-X	Stainless steel worktop · small	861 x 500 x 40	073059
V6000-01541-X	Stainless steel worktop combined · medium	1541 x 500 x 40	073158
V6000-01357-X	Stainless steel worktop · medium	1357 x 500 x 40	073073
V6000-01725-X	Stainless steel worktop · medium	1725 x 500 x 40	073097
V6000-02215-X	Stainless steel worktop combined · large	2215 x 500 x 40	073172
V6000-02404-X	Stainless steel worktop combined · large	2404 x 500 x 40	073196
V6000-02036-X	Stainless steel worktop · large	2036 x 500 x 40	073110
V6000-02588-X	Stainless steel worktop · large	2588 x 500 x 40	073134



## Stainless steel worktop

VIGOR No.	Designation	LxWxH mm	EAN 4047728+
V6000-0860-X	Stainless steel worktop · pentagonal	883 x 500 x 40	073219

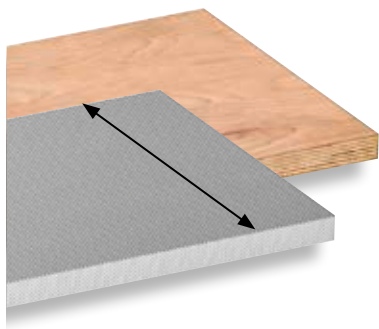

# 700mm



## Wooden worktop

• Fixation on Storage System lower cabinets

VIGOR No.	Designation	LxWxH mm	EAN 4047728+
V6000-0676-D	Deep wooden worktop · small	676 x 700 x 40	075794
V6000-0861-D	Deep wooden worktop · small	861 x 700 x 40	075787
V6000-01357-D	Deep wooden worktop · medium	1357 x 700 x 40	073486
V6000-01725-D	Deep wooden worktop · medium	1725 x 700 x 40	073493
V6000-02036-D	Deep wooden worktop · large	2036 x 700 x 40	073509
V6000-02588-D	Deep wooden worktop · large	2588 x 700 x 40	073516



## Wooden worktop

VIGOR No.	Designation	LxWxH mm	EAN 4047728+
V6000-01083-D	Deep wooden worktop · pentagonal	1083 x 700 x 40	075039



## Stainless steel worktop

• Fixation on Storage System lower cabinets

VIGOR No.	Designation	LxWxH mm	EAN 4047728+
V6000-0676-XD	Deep stainless steel worktop · small	676 x 700 x 40	075640
V6000-0861-XD	Deep stainless steel worktop · small	881 x 700 x 40	075657
V6000-01357-XD	Deep stainless steel worktop · medium	1357 x 700 x 40	073448
V6000-01725-XD	Deep stainless steel worktop · medium	1725 x 700 x 40	073455
V6000-02036-XD	Deep stainless steel worktop · large	2036 x 700 x 40	073462
V6000-02588-XD	Deep stainless steel worktop · large	2588 x 700 x 40	073479



## Stainless steel worktop

VIGOR No.	Designation	LxWxH mm	EAN 4047728+
V6000-01083-XD	Deep stainless steel worktop · pentagonal	1083 x 700 x 40	075022



## Set of perforated tool panel plates

- Compatible with VIGOR tool hook sets

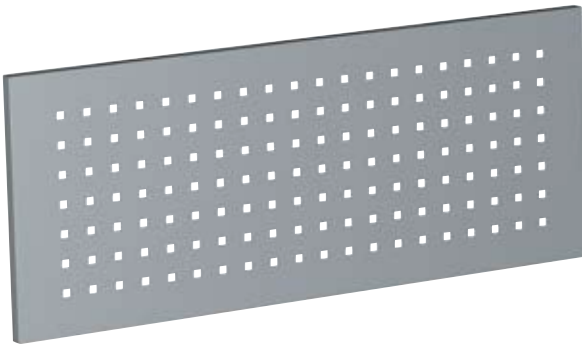

VIGOR No.	Designation		EAN 4047728+
<b>V6000-05</b>	Set of perforated tool panel plates · 676 x 342 mm	2	<b>048286</b>
<b>V6000-015</b>	Set of perforated tool panel plates · 861 x 342 mm	2	<b>055260</b>
<b>V6000-015S</b>	Perforated tool panel plate · 861 x 301 mm	-	<b>072991</b>
<b>V6000-015S-E</b>	Perforated tool panel plate · 861 X 301 mm	-	<b>084758</b>
<b>V6000-015SXL</b>	Perforated tool panel plate · 861 x 985 mm	-	<b>072984</b>
<b>V6000-048</b>	Corner perforated tool panel plate	-	<b>076135</b>
<b>V6000-05S</b>	Perforated tool panel plate · 676 x 301 mm	-	<b>073011</b>
<b>V6000-05SXL</b>	Perforated tool panel plate · 676 x 985 mm	-	<b>073004</b>

## Perforated tool panel plate with power supply

- Toggle switch for deactivating the power supply
- Only suitable for the lowest level
- Magnetic cover protects against soiling
- Integrated 3-way protective earth socket strip 230 V, 50/60 Hz
- 4 USB ports (4x 2.1 A)



VIGOR No.	Designation	EAN 4047728+
<b>V6000-05SP</b>	Perforated tool panel plate with power supply 676 mm	<b>073981</b>
<b>V6000-015SP</b>	Perforated tool panel plate with power supply 861 mm	<b>073998</b>

## Storage shelf

- Storage shelf for V6000-03 · V6000-03XL



VIGOR No.	Designation		L x W x H mm	EAN 4047728+
<b>V6000-017</b>	Storage shelf set for single-hinged door cabinet V6000-03	2	524 x 476 x 13	<b>055420</b>
<b>V6000-017XL</b>	Storage shelf set for double-hinged door cabinet for V6000-03XL	2	1045 x 476 x 13	<b>070669</b>

## Storage shelf

- Storage shelf for V6000-02 · V6000-02XL



VIGOR No.	Designation	L x W x H mm	EAN 4047728+
<b>V6000-018</b>	Storage shelf for double hinged door lower cabinet V6000-02	601 x 464 x 13	<b>059275</b>
<b>V6000-018XL</b>	Storage shelf for double-hinged door lower cabinet V6000-02XL	785 x 464 x 13	<b>070652</b>

**V6000-043**, EAN 4047728**073813**

## Base panel for lower cabinet with extension frame

- To neatly close off the side walls of all lower cabinets with extension frame
- Prevents dust and dirt from getting in
- Delivery including screws
- Base panel · 650 mm

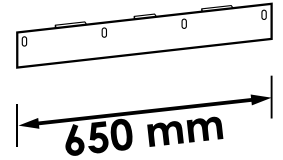

**V6000-09**, EAN 4047728**048422**

## Base panel for high cabinets

- To neatly close off the side walls of all high cabinets
- Prevents dust and dirt from getting in
- Delivery including screws
- Base panel · 498 mm

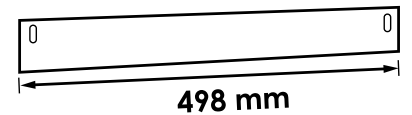

**V6000-010**, EAN 4047728**048439**

## Base panel for lower cabinets

- To neatly close off the side walls of all lower cabinets
- Prevents dust and dirt from getting in
- Delivery including screws
- Base panel · 472 mm

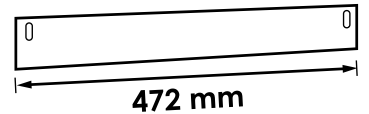

**V6000-040/4**, EAN 4047728**070645**

## Set of connection plates

- Rear connection of two lower cabinets
- Contents: 4 connection plates including screws and nuts

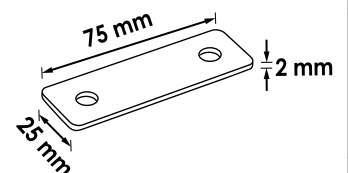

**V6000-041/4**, EAN 4047728**070676**

## Storage shelf support set

- For securing storage shelves



**V6000-020**, EAN 4047728**069588**

## Spare lock for VIGOR storage system

- Including 2 keys
- For all VIGOR hinged-door cabinets:  
V6000-030 · V6000-030XL · V6000-02 · V6000-02XL · V6000-03 · V6000-03XL · V6000-011 · V6000-046 · V6000-046XL



**V6000-050**, EAN 4047728**073417**

## Storage shelf

- Simple hanging on 9x9 mm perforated tool panel grid
- Maximum load: 6 kg

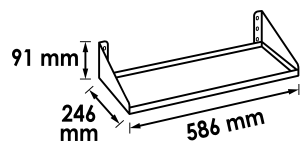
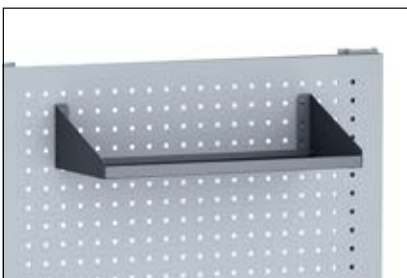

**V6000-051**, EAN 4047728**073349**

## Can holder

- For storing cans
- Simple hanging on 9x9 mm perforated tool panel grid

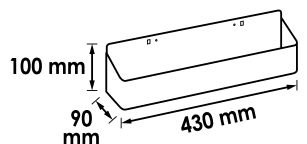
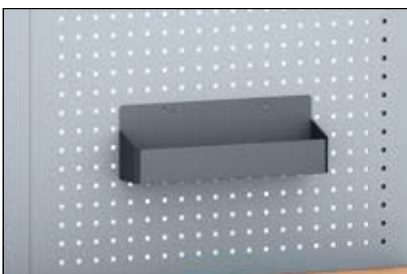



**V6000-052**, EAN 4047728073653

## Hanging rail

- Only together with V6000-053
- For hanging a total of 6 visual storage boxes
- Simple hanging on 9x9 mm perforated tool panel grid

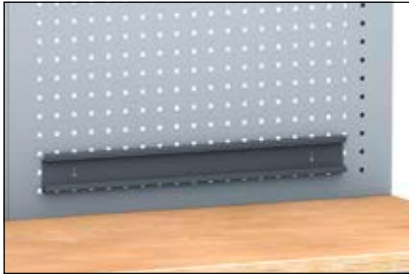

**V6000-053**, EAN 4047728074223

## Visual storage box set

- For storing small parts
- Combines optimally with V6000-052
- 3 visual storage boxes included in delivery
- Maximum load: 3 kg



**V6000-054**, EAN 4047728074001

## Monitor holder

- Cable routing on holder
- The retaining plate and the installation material are included in delivery
- Total outreach:
  - short swivel arm: 175 mm
  - long swivel arm: 265 mm
  - short and long combined: 350 mm
- Simple hanging on 9x9 mm perforated tool panel grid
- Maximum load: 5 kg
- 180° swivelling

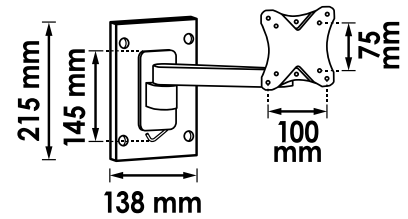
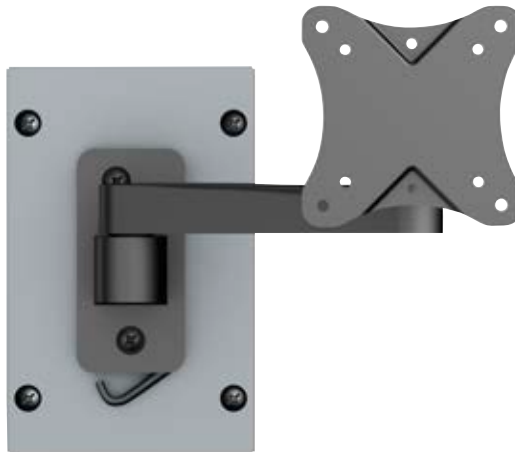

**V6000-059**, EAN 4047728085557

## Cordless tool holder

- Holds 2 cordless tools
- Upper area offers space for chargers and additional batteries
- Simple hanging on 9x9 mm perforated tool panel grid

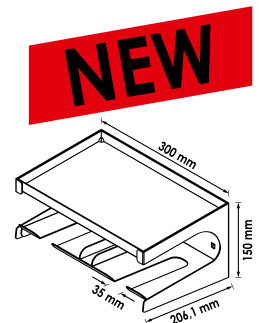

**V6000-060**, EAN 4047728**085526**

## Glove box holder

- Ideal together with Vigor Grip nitrile gloves
- Direct and ergonomic access thanks to easy removal
- Can be attached to all VIGOR tool trolleys and to 9x9 mm perforated panel grids
- Inside dimensions 250 x 112 x 123 mm



**NEW**

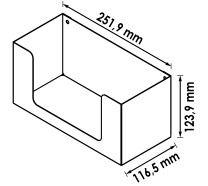

**V6000-055**, EAN 4047728**077118**

## Torque wrench bracket

- For common torque wrenches
- With edge protection
- Opening width 19.5 mm



**V6000-055XL**, EAN 4047728**077125**

## Torque wrench bracket · big

- For common torque wrenches
- With edge protection
- Opening width 26 mm



**V6000-047LR-E**, EAN 4047728082914

Perforated tool panel bracket set · left and right

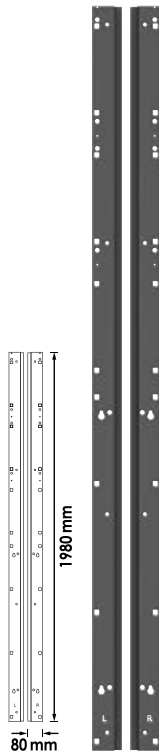

**NEW**



**V6000-047M-E**, EAN 4047728082907

Perforated tool panel bracket · middle

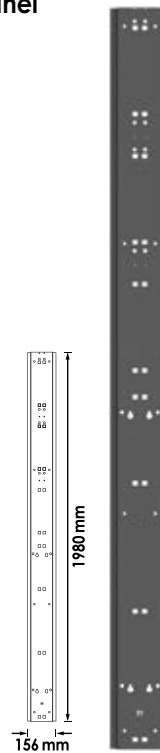

**NEW**



VIGOR No.	Designation		L mm	EAN 4047728+
<b>V6000-047LRS-E</b>	Perforated tool panel bracket set, short · left and right	2	1285	<b>082921</b>
<b>V6000-047MS-E</b>	Perforated tool panel bracket set, short · middle	1	1285	<b>082891</b>

**NEW**

**V7283**, EAN 4047728072847

LED light strip · extension

- Optimum lighting for the work surface of the Vigor storage system
- Magnetic rear side for fastening to substrates containing iron
- Adhesive strips for non-magnetic substrates included in delivery
- Robust aluminium housing
- LED light strip length: 527 mm
- Total length (including cable): 2527 mm
- Power: 1000 lm
- Maximum of 3 LED light strips can be combined with one power supply unit



**V7283/2**, EAN 4047728072830

LED light strip · basic set

- Optimum lighting for the work surface of the Vigor storage system
- Magnetic rear side for fastening to substrates containing iron
- Adhesive strips for non-magnetic substrates included in delivery
- Robust aluminium housing
- LED light strip length: 527 mm
- Total length (including cable): 2527 mm
- Power: 1000 lm
- Maximum of 3 LED light strips can be combined with one power supply unit
- On/Off switch included
- Includes power supply unit 230 V, 1.5 A output



## Tool storage: organisation is half the work

Your tools deserve a place that's not only tidy but also accessible. With our selection of tool storage solutions, you can ensure that everything from screwdrivers to power tools has its own place – organised, protected and always ready to hand. Storing your tools in soft foam inserts offers the best protection against damage.

The durable inserts absorb shocks and vibrations perfectly. This type of storage makes organisation easier – while giving you quick access to every tool.

Discover now how you can save time and boost your efficiency with our smart storage solutions. Are you familiar with our soft foam insert configurator? You can find it at: [vigor-equipment.com/einlagenkonvigator](http://vigor-equipment.com/einlagenkonvigator)

## Tool storage

Multiboxes

92-93

Soft foam inserts

94-117

**V4700-L**, EAN 4047728**046794**

**Multibox-L · empty**

- Lightweight plastic box
- Maximum loading capacity: 90 kg

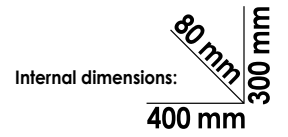
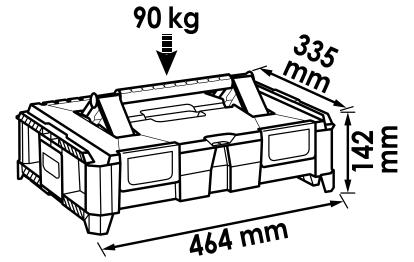

**V4700-XL**, EAN 4047728**049269**

**Multibox-XL · empty**

- Lightweight plastic box
- Maximum loading capacity: 90 kg

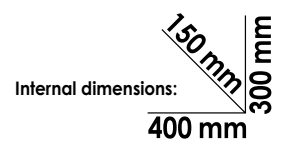
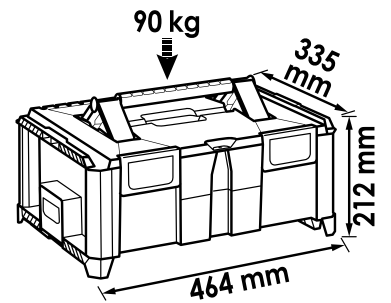

**V4700-XXL**, EAN 4047728**049276**

## Multibox-XXL · empty

- Lightweight plastic box
- Maximum loading capacity: 90 kg

M

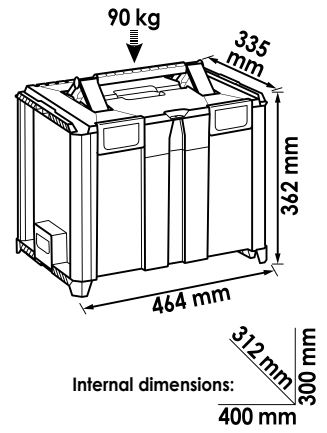

**V4700-A**, EAN 4047728**075077**

## Multibox expansion set

- For combining VIGOR multiboxes with third-party products
- Simple "click" system for quick connections
- Multibox expansion set



**V4700-R**, EAN 4047728**049283**

## Mechanic's creeper for multibox

- Mechanic's creeper for V4700-L · V4700-XL and V4700-XXL
- Maximum loading capacity: 200 kg

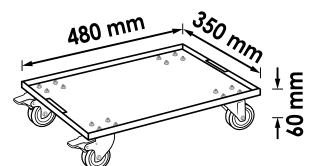

## Illustration of the drawer pictograms



**S**



**L**

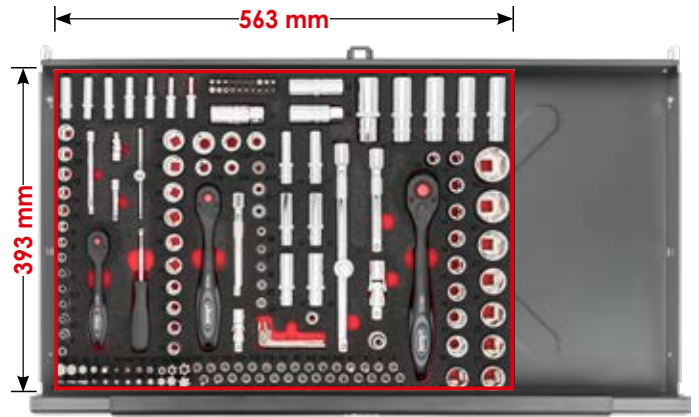

**XL**

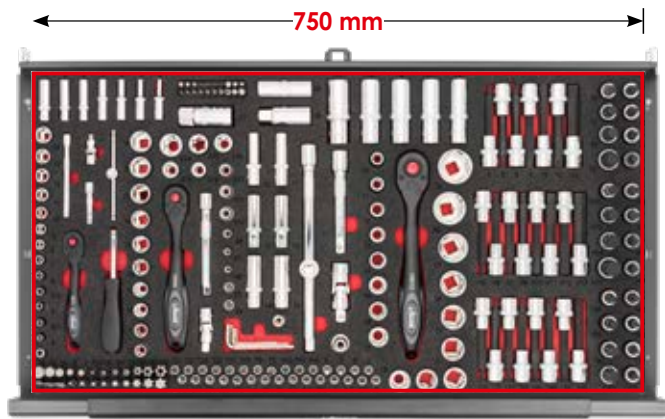

**XD**

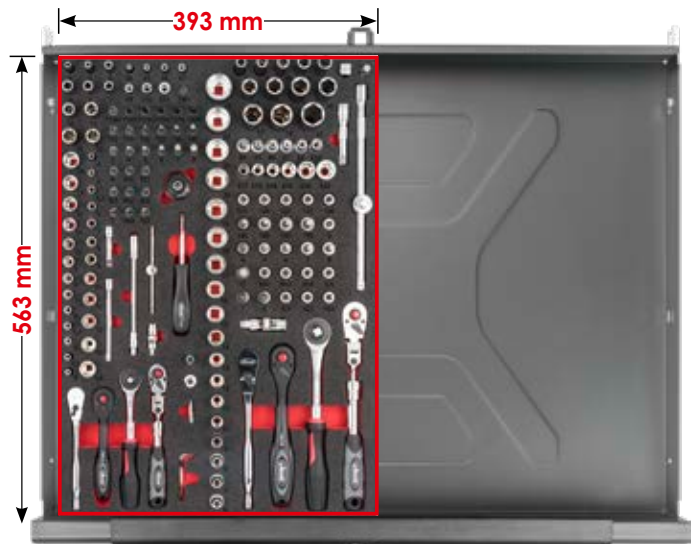



# Soft foam inserts



**V4971N**, EAN 4047728085021

Socket tool set

**NEW**



XX	■		Design	Size
13 x	6.3 1/4	●		4 · 4.5 · 5 · 5.5 · 6 · 7 · 8 · 9 · 10 · 11 · 12 · 13 · 14 mm
7 x	6.3 1/4	●		4 · 5 · 6 · 7 · 8 · 9 · 10 mm
7 x	6.3 1/4	●		E4 · E5 · E6 · E7 · E8 · E10 · E11
6 x	6.3 1/4	○		3 · 4 · 5 · 6 · 7 · 8 mm
3 x	6.3 1/4	+		PH1 · PH2 · PH3
3 x	6.3 1/4	●		0.8x4-1x5.5-1.2x7 mm
3 x	6.3 1/4	+		PZ1 · PZ2 · PZ3
6 x	6.3 1/4	●		T10 · T15 · T20 · T25 · T30 · T40

XX	■		Design	Size
7 x	6.3 1/4	+		T9H · T10H · T15H · T20H · T25H · T27H · T30H
1 x	-	6.3 1/4		150 mm
1 x	6.3 1/4	6.3 1/4		40 mm
1 x	10 3/8	6.3 1/4		27 mm
1 x	6.3 1/4	6.3 1/4		110 mm
1 x	6.3 1/4	6.3 1/4		145 mm
1 x	6.3 1/4	6.3 1/4		50 mm
1 x	6.3 1/4	6.3 1/4		100 mm
2 x	-	○		1.3 · 2 mm
1 x	-	6.3 1/4		150 mm

**V4971N-L**, EAN 4047728084390

Soft foam insert · empty



**V4973N**, EAN 4047728085014

Socket tool set

**NEW**



XX	■		Design	Size
18 x	10 3/8	●		6 · 7 · 10 · 8 · 9 · 10 · 11 · 12 · 13 · 14 · 15 · 16 · 17 · 18 · 19 · 20 · 21 · 22 · 24 mm
10 x	10 3/8	●		8 · 9 · 10 · 11 · 12 · 13 · 14 · 15 · 17 · 19 mm
7 x	10 3/8	○		3 · 4 · 5 · 6 · 7 · 8 · 10 mm
3 x	10 3/8	●		0.8x5.5-1x7-1.2x8 mm
3 x	10 3/8	+		PH1 · PH2 · PH3

XX	■		Design	Size
3 x	10 3/8	+		PZ1 · PZ2 · PZ3
9 x	10 3/8	●		T15 · T20 · T25 · T27 · T30 · T40 · T45 · T50 · T55
2 x	10 3/8	●		16 · 21 mm
1 x	10 3/8	8 3/8		28 mm
1 x	12 1/2	10 3/8		40 mm
1 x	10 3/8	10 3/8		50 mm
1 x	10 3/8	10 3/8		75 mm
1 x	10 3/8	10 3/8		250 mm
1 x	-	10 3/8		198 mm

**V4973N-L**, EAN 4047728084413

Soft foam insert · empty



**V4975N**, EAN 4047728085007

Socket tool set

**NEW**



XX	■		Design	Size
18 x	12 1/2 1/2	●		10 · 11 · 12 · 13 · 14 · 15 · 16 · 17 · 18 · 19 · 20 · 21 · 22 · 23 · 24 · 27 · 30 · 32 mm
2 x	12 1/2 1/2	●		16 · 21 mm

XX	■		Design	Size
1 x	-	12 1/2 1/2		250 mm
1 x	12 1/2 1/2	12 1/2 1/2		75 mm
1 x	12 1/2 1/2	12 1/2 1/2		125 mm
1 x	12 1/2 1/2	12 1/2 1/2		250 mm
1 x	-	12 1/2 1/2		250 mm

**V4975N-L**, EAN 4047728084406

Soft foam insert · empty



**V7323**, EAN 4047728073240

Socket set



XX	■	Design	Size
3 x	6.3 1/4		11 · 12 · 13 mm
5 x	10 3/8		E10 · E12 · E14 · E16 · E18
8 x	12 1/2		10 · 12 · 14 · 16 · 17 · 18 · 19 · 22 mm

XX	■	Design	Size
5 x	12 1/2		E14 · E16 · E18 · E20 · E22
5 x	12 1/2		15 · 17 · 19 · 21 · 22 mm



**V7323-L**, EAN 4047728073233

Soft foam insert · empty



**V5602**, EAN 4047728056021

Impact socket set



XX	■	Design	Size
13 x	12 1/2		10 · 11 · 12 · 13 · 14 · 15 · 16 · 17 · 18 · 19 · 21 · 22 · 24 mm

XX	■	Design	Size
13 x	12 1/2		10 · 11 · 12 · 13 · 14 · 15 · 16 · 17 · 18 · 19 · 21 · 22 · 24 mm



**V5602-L**, EAN 4047728056038

Soft foam insert · empty



**V5099**, EAN 4047728050999

Screwdriver socket set

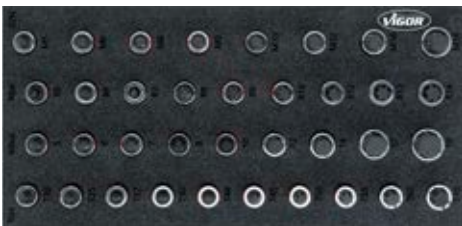

XX	■	Design	Size
10 x	12 1/2		T20 · T25 · T27 · T30 · T40 · T45 · T50 · T55 · T60 · T70
9 x	12 1/2		M5 · M6 · M7 · M8 · M9 · M10 · M12 · M13 · M14

XX	■	Design	Size
9 x	12 1/2		5 · 6 · 7 · 8 · 10 · 12 · 14 · 17 · 19 mm
8 x	12 1/2		M5 · M6 · M8 · M9 · M10 · M12 · M14 · M16



**V5099-L**, EAN 4047728051002

Soft foam insert · empty



**V5095**, EAN 4047728050951

T screwdriver socket set



XX	■	Design	Size
6 x	12 1/2		T40 · T45 · T50 · T55 · T60 · T70
10 x	12 1/2		T20 · T25 · T27 · T30 · T40 · T45 · T50 · T55 · T60 · T70

XX	■	Design	Size
10 x	12 1/2		T20 · T25 · T27 · T30 · T40 · T45 · T50 · T55 · T60 · T70



**V5095-L**, EAN 4047728050968

Soft foam insert · empty



# Soft foam inserts



**V5075**, EAN 4047728**050753**

Ratcheting combination wrench set · short



XX	Design	Size
12 x		8 · 9 · 10 · 11 · 12 · 13 · 14 · 15 · 16 · 17 · 18 · 19 mm



**V5075-L**, EAN 4047728**050760**

Soft foam insert · empty



**V4987**, EAN 4047728**049870**

Ratcheting combination wrench set

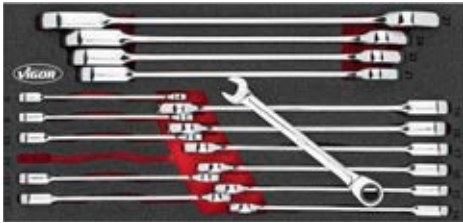

XX	Design	Size
16 x		8 · 9 · 10 · 11 · 12 · 13 · 14 · 15 · 16 · 17 · 18 · 19 · 21 · 22 · 24 · 27 mm



**V4987-L**, EAN 4047728**049863**

Soft foam insert · empty



**V5077**, EAN 4047728**050777**

Ratcheting combination wrench set with hinge



XX	Design	Size
12 x		8 · 9 · 10 · 11 · 12 · 13 · 14 · 15 · 16 · 17 · 18 · 19 mm



**V5077-L**, EAN 4047728**050784**

Soft foam insert · empty



**V4989**, EAN 4047728**049894**

Screwdriver set



XX	Design	Size	XX	Design	Size
6 x		0.6x3 · 0.8x4 · 1x5.5 · 1.2x6.5 · 1.6x8 · 1.6x10 mm	1 x		PH2
1 x		PH3	3 x		PH1 · PH2 · PH3
1 x		1x5.5 mm			



**V4989-L**, EAN 4047728**049887**

Soft foam insert · empty



**V5068**, EAN 4047728**050685**  
Screwdriver set with impact cap

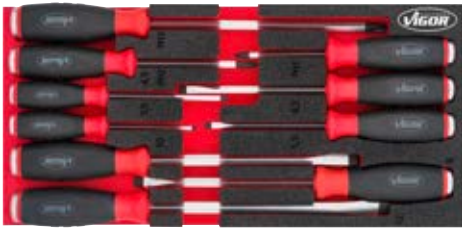

XX	Design	Size
3 x		PH1 · PH2 · PH3

XX	Design	Size
7 x		0.6x3.5-1x4.5-1x5.5- 1.2x6.5 · 1.6x8 · 1.6x10 · 2x12 mm



**V5068-L**, EAN 4047728**050678**

Soft foam insert · empty



**V4991**, EAN 4047728**049917**  
T screwdriver set

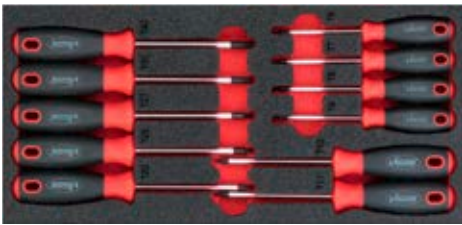

XX	Design	Size
11 x		T6 · T7 · T8 · T9 · T10 · T15 · T20 · T25 · T27 · T30 · T40



**V4991-L**, EAN 4047728**049900**

Soft foam insert · empty



**V4995**, EAN 4047728**049955**  
Double joint pliers set



XX	Design	Size
1 x		340 mm
1 x		335 mm

XX	Design	Size
1 x		300 mm
1 x		290 mm



**V4995-L**, EAN 4047728**049948**

Soft foam insert · empty



**V5004**, EAN 4047728**050043**  
Grip pliers set



XX	Design	Size
1 x		16 - 27 mm
1 x		11 - 19 mm
1 x		125 mm

XX	Design	Size
1 x		250 mm
1 x		150 mm



**V5004-L**, EAN 4047728**050005**

Soft foam insert · empty



# Soft foam inserts



**V5006**, EAN 4047728**050067**  
Hammer and chisel set



XX	Design	Size
1 x		6 mm
1 x		18 mm
1 x		Ø 4 mm

XX	Design	Size
6 x		Ø 2 · 3 · 4 · 5 · 6 · 8 mm
1 x		Ø 40 mm
1 x		800 g

**V5006-L**, EAN 4047728**050050**  
Soft foam insert · empty



**V5070**, EAN 4047728**050708**  
Hook and scraper set



XX	Design	Size
1 x		130 mm
1 x		130 mm
1 x		130 mm
1 x		130 mm
1 x		260 mm

XX	Design	Size
1 x		260 mm
1 x		260 mm
1 x		260 mm
1 x		260 mm

**V5070-L**, EAN 4047728**050692**  
Soft foam insert · empty



**V5017**, EAN 4047728**050173**  
Scraper set



XX	Design	Size
1 x		22 mm
1 x		32 mm
1 x		32 mm
1 x		20 mm

XX	Design	Size
1 x		20 mm
1 x		40 mm
1 x		10 x

**V5017-L**, EAN 4047728**050166**  
Soft foam insert · empty



**V5072**, EAN 4047728**050722**  
File set



XX	Design	Size
1 x		310 mm
1 x		310 mm
1 x		310 mm

XX	Design	Size
1 x		310 mm
1 x		310 mm

**V5072-L**, EAN 4047728**050715**  
Soft foam insert · empty



**V4999N**, EAN 4047728**078726**

Pliers set

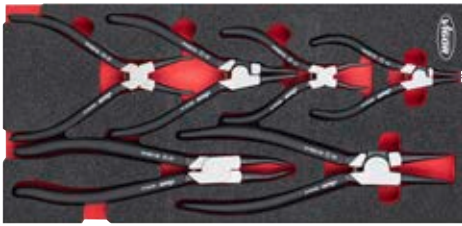

XX	Design	Size
3 x		140 · 180 · 230 mm

XX	Design	Size
3 x		140 · 180 · 230 mm

**V4999N-L**, EAN 4047728**077989**

Soft foam insert · empty



**V5633N**, EAN 4047728**078740**

Pliers set



XX	Design	Size
1 x		250 mm
1 x		200 mm

XX	Design	Size
1 x		180 mm
1 x		160 mm

**V5633N-L**, EAN 4047728**078009**

Soft foam insert · empty



**V6721N**, EAN 4047728**084802**  
Double open-end wrench set

**NEW**



XX	Design	Size
12 x		6 x 7 · 8 x 9 · 10 x 11 · 12 x 13 · 14 x 15 · 16 x 17 · 18 x 19 · 20 x 22 · 21 x 23 · 24 x 27 · 25 x 28 · 30 x 32 mm

**V6721N-L**, EAN 4047728**084604**

Soft foam insert · empty



**V6722N**, EAN 4047728**084789**  
Double box-end wrench set

**NEW**



XX	Design	Size
11 x		6 x 7 · 8 x 9 · 10 x 11 · 12 x 13 · 14 x 15 · 16 x 17 · 18 x 19 · 20 x 22 · 21 x 23 · 24 x 27 · 25 x 28 mm

**V6722N-L**, EAN 4047728**084598**

Soft foam insert · empty



# Soft foam inserts



**V5603**, EAN 4047728**078917**  
Impact screwdriver socket set

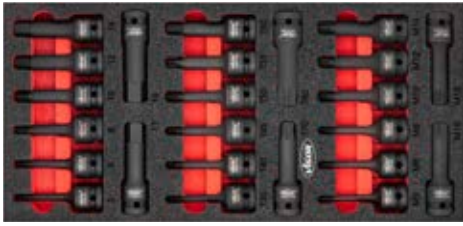

XX			Design	Size
8 x	12.9	1/2		5 · 6 · 8 · 10 · 12 · 14 · 17 · 19 mm
8 x	12.9	1/2		M5 · M6 · M8 · M10 · M12 · M14 · M16 · M18

XX			Design	Size
8 x	12.9	1/2		T30 · T40 · T45 · T50 · T55 · T60 · T70 · T80

**V5603-L**, EAN 4047728**078580**

Soft foam insert · empty



**V6723N**, EAN 4047728**084819**  
Combination wrench set

**NEW**



XX			Design	Size
18 x				6 · 7 · 8 · 9 · 10 · 11 · 12 · 13 · 14 · 15 · 16 · 17 · 18 · 19 · 21 · 22 · 24 · 27 mm

**V6723N-L**, EAN 4047728**084611**

Soft foam insert · empty



**V7324**, EAN 4047728**080262**  
Impact socket set



XX			Design	Size
9 x	12.9	1/2		10 · 11 · 12 · 13 · 14 · 15 · 16 · 17 · 19 mm
13 x	12.9	1/2		10 · 11 · 12 · 13 · 14 · 15 · 16 · 17 · 18 · 19 · 21 · 22 · 24 mm
5 x	12.9	1/2		15 · 17 · 19 · 21 · 22 mm

XX			Design	Size
1 x	12.9	1/2		17 mm
1 x	12.9	1/2		18.5 · 19.5 mm
1 x	12.9	1/2		21 mm
1 x	12.9	1/2		22.2 mm

**V7324-L**, EAN 4047728**080248**

Soft foam insert · empty



**V7520**, EAN 4047728**075824**  
12-point socket set

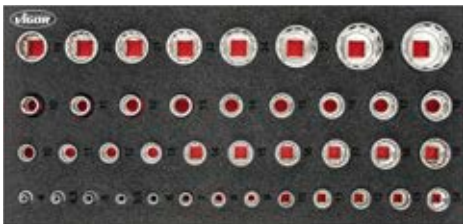

XX			Design	Size
17 x	12.9	1/2		10 · 11 · 12 · 13 · 14 · 15 · 16 · 17 · 18 · 19 · 20 · 21 · 22 · 24 · 27 · 30 · 32 mm
10 x	10	3/8		10 · 11 · 12 · 13 · 14 · 15 · 16 · 17 · 18 · 19 mm

XX			Design	Size
13 x	6.3	1/4		4 · 4.5 · 5 · 5.5 · 6 · 7 · 8 · 9 · 10 · 11 · 12 · 13 · 14 mm

**V7520-L**, EAN 4047728**075800**

Soft foam insert · empty



**V4188**, EAN 4047728**041881**

Socket tool set



XX	■	●	Design	Size	XX	■	●	Design	Size
5 x	6.3 1/4	+		R5 · R6 · R7 · R8 · R9	3 x	6.3 1/4	+		PH0 · PH1 · PH2
3 x	6.3 1/4	+		T5 · T6 · T7	3 x	6.3 1/4	+		PZ0 · PZ1 · PZ2
3 x	6.3 1/4	○		M5 · M6 · M8	7 x	6.3 1/4	+		T9 · T10 · T15 · T20 · T25 · T27 · T30
9 x	6.3 1/4	+		T7H · T10H · T15H · T20H · T25H · T27H · T30H · T40H · T45H	7 x	6.3 1/4	+		T9H · T10H · T15H · T20H · T25H · T27H · T30H
6 x	8 9/16	+		T40 · T45 · T50 · T55 · T60 · T70	6 x	10 3/8	○		E10 · E11 · E12 · E14 · E16 · E18
5 x	8 9/16	○		7 · 8 · 10 · 12 · 14 mm	6 x	10 3/8	○		10 · 11 · 12 · 13 · 14 · 15 mm
2 x	8 9/16	+		PH3 · PH4	10 x	10 3/8	○		10 · 11 · 12 · 13 · 14 · 15 · 16 · 17 · 18 · 19 mm
2 x	8 9/16	+		PZ3 · PZ4	17 x	12 1/2	○		10 · 11 · 12 · 13 · 14 · 15 · 16 · 17 · 18 · 19 · 20 · 21 · 22 · 24 · 27 · 30 · 32 mm
3 x	8 9/16	○		1.6x8 · 1.6x10 · 2x12 mm	5 x	12 1/2	○		16 · 17 · 18 · 19 · 22 mm
6 x	8 9/16	+		T40H · T45H · T50H · T55H · T60H · T70H	2 x	12 1/2	+		E20 · E24
2 x	-	○		1.3 · 2 mm	13 x	6.3 1/4	○		4 · 4.5 · 5 · 5.5 · 6 · 7 · 8 · 9 · 10 · 11 · 12 · 13 · 14 mm
1 x	10 3/8	8 9/16		28 mm	7 x	6.3 1/4	○		4 · 5 · 6 · 7 · 8 · 9 · 10 mm
1 x	12 1/2	8 9/16		37 mm	5 x	6.3 1/4	+		E4 · E5 · E6 · E7 · E8
1 x	-	6.3 1/4		150 mm	1 x	-	6.3 1/4		150 mm
1 x	6.3 1/4	6.3 1/4		110 mm	1 x	-	10 3/8		198 mm
1 x	-	12 1/2		43.7 mm	1 x	-	12 1/2		250 mm
1 x	10 3/8	10 3/8		50 mm	1 x	6.3 1/4	6.3 1/4		40 mm
1 x	12 1/2	12 1/2		75 mm	1 x	10 3/8	10 3/8		50 mm
1 x	6.3 1/4	6.3 1/4		50 mm	1 x	6.3 1/4	6.3 1/4		100 mm
1 x	-	12 1/2		125 mm	1 x	10 3/8	10 3/8		125 mm
4 x	6.3 1/4	○		3 · 4 · 5 · 6 mm	1 x	12 1/2	12 1/2		125 mm
4 x	6.3 1/4	○		0.8x4 · 1x5.5 · 1.2x6.5 · 1.2x7 mm	1 x	12 1/2	12 1/2		250 mm
					1 x	10 3/8	○		18 mm
					2 x	12 1/2	○		16 · 21 mm

**V4130**, EAN 4047728**041300**

Soft foam insert · empty





# Soft foam inserts



**V2837**, EAN 4047728028370

Socket set

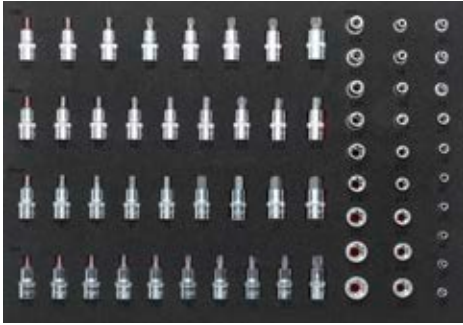

XX	■		Design	Size
7 x	6.3	1/4		E4 · E5 · E6 · E7 · E8 · E10 · E11
12 x	10	3/8		E4 · E5 · E6 · E7 · E8 · E10 · E11 · E12 · E14 · E16 · E18 · E20
9 x	12.5	1/2		E10 · E11 · E12 · E14 · E16 · E18 · E20 · E22 · E24
8 x	12.5	1/2		M5 · M6 · M8 · M9 · M10 · M12 · M14 · M16

XX	■		Design	Size
9 x	12.5	1/2		5 · 6 · 7 · 8 · 10 · 12 · 14 · 17 · 19 mm
9 x	12.5	1/2		M5 · M6 · M7 · M8 · M9 · M10 · M12 · M13 · M14
10 x	12.5	1/2		T20 · T25 · T27 · T30 · T40 · T45 · T50 · T55 · T60 · T70



**V2838**, EAN 4047728028387

Soft foam insert · empty



**V5109**, EAN 4047728051095

Socket set



XX	■		Design	Size
16 x	20	3/4		19 · 21 · 22 · 23 · 24 · 26 · 27 · 28 · 30 · 32 · 34 · 36 · 38 · 41 · 46 · 50 mm
1 x	-	20		500 mm

XX	■		Design	Size
1 x	20	3/4		200 mm
1 x	20	3/4		100 mm
1 x	20	3/4		400 mm
1 x	-	20		450 mm



**V5109-L**, EAN 4047728051101

Soft foam insert · empty



**V4753**, EAN 4047728**047531**

Screwdriver socket set

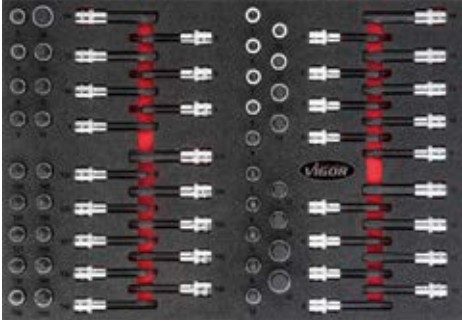

XX	■	Design	Size
9 x	12.5 1/2		M5 · M6 · M7 · M8 · M9 · M10 · M12 · M13 · M14
9 x	12.5 1/2		M5 · M6 · M7 · M8 · M9 · M10 · M12 · M13 · M14
10 x	12.5 1/2		T20 · T25 · T27 · T30 · T40 · T45 · T50 · T55 · T60 · T70
10 x	12.5 1/2		T20 · T25 · T27 · T30 · T40 · T45 · T50 · T55 · T60 · T70

XX	■	Design	Size
7 x	12.5 1/2		M5 · M6 · M8 · M9 · M10 · M12 · M14
8 x	12.5 1/2		M5 · M6 · M8 · M9 · M10 · M14 · M16 · M12
8 x	12.5 1/2		5 · 6 · 7 · 8 · 10 · 11 · 12 · 13 mm
9 x	12.5 1/2		5 · 6 · 7 · 8 · 10 · 12 · 14 · 17 · 19 mm

**V4752**, EAN 4047728**047524**

Soft foam insert · empty

**V4727**, EAN 4047728**047272**

Screwdriver socket set

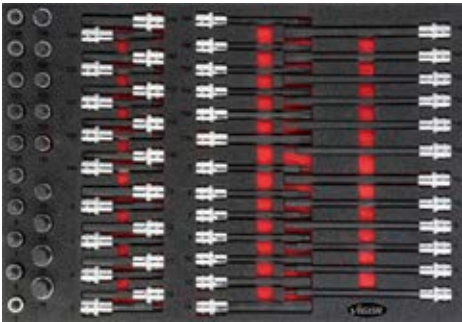

XX	■	Design	Size
10 x	12.5 1/2		T20 · T25 · T27 · T30 · T40 · T45 · T50 · T55 · T60 · T70
10 x	12.5 1/2		T20 · T25 · T27 · T30 · T40 · T45 · T50 · T55 · T60 · T70
6 x	12.5 1/2		T40 · T45 · T50 · T55 · T60 · T70
6 x	12.5 1/2		T40 · T45 · T50 · T55 · T60 · T70

XX	■	Design	Size
9 x	12.5 1/2		5 · 6 · 7 · 8 · 10 · 12 · 14 · 17 · 19 mm
8 x	12.5 1/2		5 · 6 · 7 · 8 · 10 · 11 · 12 · 13 mm
7 x	12.5 1/2		5 · 6 · 7 · 8 · 10 · 12 · 14 mm
6 x	12.5 1/2		5 · 6 · 7 · 8 · 10 · 12 mm

**V4726**, EAN 4047728**047265**

Soft foam insert · empty

**V4729**, EAN 4047728**047296**

Screwdriver socket set

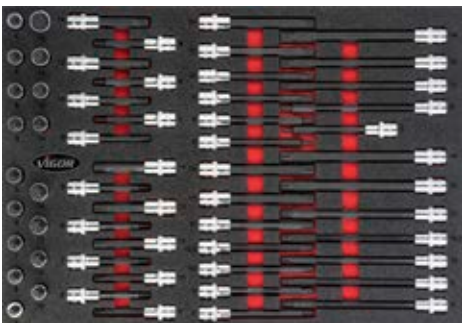

XX	■	Design	Size
8 x	12.5 1/2		M5 · M6 · M8 · M9 · M10 · M12 · M14 · M16
7 x	12.5 1/2		M5 · M6 · M8 · M9 · M10 · M12 · M14
7 x	12.5 1/2		M5 · M6 · M8 · M9 · M10 · M12 · M14
4 x	12.5 1/2		M8 · M10 · M12 · M14

XX	■	Design	Size
9 x	12.5 1/2		M5 · M6 · M7 · M8 · M9 · M10 · M12 · M13 · M14
9 x	12.5 1/2		M5 · M6 · M7 · M8 · M9 · M10 · M12 · M13 · M14
7 x	12.5 1/2		M8 · M9 · M10 · M10.3 · M12 · M13 · M14
7 x	12.5 1/2		M8 · M9 · M10 · M10.3 · M12 · M13 · M14

**V4728**, EAN 4047728**047289**

Soft foam insert · empty

# Soft foam inserts



**V4230**, EAN 4047728**042307**

Screwdriver set



XX	Design	Size
6 x		6 · 7 · 8 · 10 · 12 · 13 mm
6 x		0.6 x 3 · 0.8 x 4 · 1 x 5.5 · 1.2 x 6.5 · 1.6 x 8 · 1.6 x 10 mm
4 x		PH0 · PH1 · PH2 · PH3
1 x		1 x 5.5 mm
1 x		PH2

XX	Design	Size
7 x		T10 · T15 · T20 · T25 · T27 · T30 · T40
1 x		0.5 x 3 mm
2 x		PH1 · PH2
4 x		0.6 x 3.5 · 1 x 4.5 · 1 x 5.5 · 1.2 x 6.5 mm

**V4231**, EAN 4047728**042314**

Soft foam insert · empty



**V5175**, EAN 4047728**051750**

T-handle screwdriver and offset screwdriver set



XX	Design	Size
9 x		1.5 · 2 · 2.5 · 3 · 4 · 5 · 6 · 8 · 10 mm
9 x		T10 · T15 · T20 · T25 · T27 · T30 · T40 · T45 · T50

XX	Design	Size
8 x		2 · 2.5 · 3 · 4 · 5 · 6 · 8 · 10 mm
8 x		T9 · T10 · T15 · T20 · T25 · T27 · T30 · T40

**V5175-L**, EAN 4047728**051767**

Soft foam insert · empty

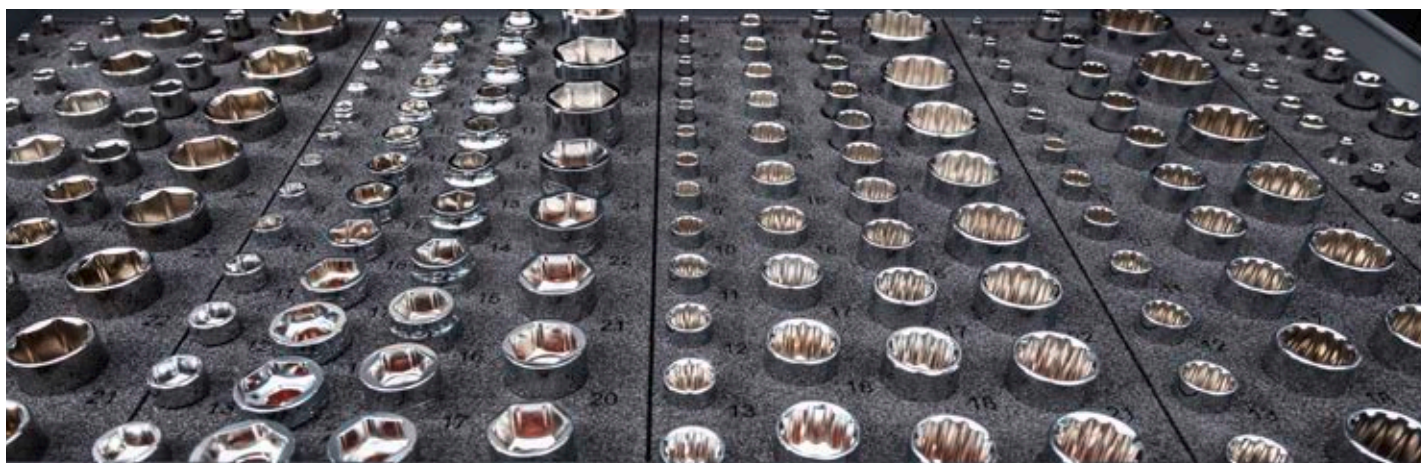

**V6821**, EAN 4047728068222

Socket set

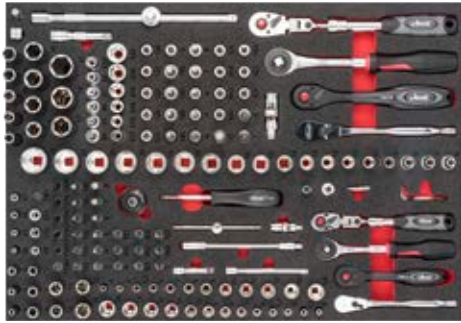

XX	■		Design	Size
12 x	10	3/8		E4 · E5 · E6 · E7 · E8 · E10 · E11 · E12 · E14 · E16 · E18 · E20
18 x	10	3/8		6 · 7 · 8 · 9 · 10 · 11 · 12 · 13 · 14 · 15 · 16 · 17 · 18 · 19 · 20 · 21 · 22 · 24 mm
10 x	10	3/8		8 · 9 · 10 · 11 · 12 · 13 · 14 · 15 · 17 · 19 mm
2 x	10	3/8		16 · 21 mm
9 x	10	3/8		T15 · T20 · T25 · T27 · T30 · T40 · T45 · T50 · T55
7 x	10	3/8		3 · 4 · 5 · 6 · 7 · 8 · 10 mm
3 x	10	3/8		PH1 · PH2 · PH3
3 x	10	3/8		PZ1 · PZ2 · PZ3
3 x	10	3/8		0.8x5.5-1x7 · 1.2x8 mm
1 x	10	3/8		250 mm
1 x	10	3/8		50 mm
1 x	10	3/8		75 mm
1 x	10	3/8		36 mm
1 x	10	3/8		27 mm
1 x	12.5	1/2		40 mm
7 x	6.3	1/4		E4 · E5 · E6 · E7 · E8 · E10 · E11
11 x	6.3	1/4		4 · 5 · 6 · 7 · 8 · 9 · 10 · 11 · 12 · 13 · 14 mm
10 x	6.3	1/4		4 · 5 · 6 · 7 · 8 · 9 · 10 · 11 · 12 · 13 mm

XX	■		Design	Size
13 x	6.3	1/4		4 · 4.5 · 5 · 5.5 · 6 · 7 · 8 · 9 · 10 · 11 · 12 · 13 · 14 mm
6 x	6.3	1/4		T10 · T15 · T20 · T25 · T30 · T40
7 x	6.3	1/4		T9H · T10H · T15H · T20H · T25H · T27H · T30H
6 x	6.3	1/4		3 · 4 · 5 · 6 · 7 · 8 mm
3 x	6.3	1/4		PH1 · PH2 · PH3
3 x	6.3	1/4		PZ1 · PZ2 · PZ3
3 x	6.3	1/4		0.8x4-1x5.5 · 1.2x6.5 mm
1 x	6.3	1/4		26 mm
1 x	-	10		198 mm
1 x	-	10		198 mm
1 x	-	10		237 mm
1 x	-	6.3		150 mm
1 x	6.3	1/4		110 mm
1 x	6.3	1/4		40 mm
1 x	6.3	1/4		145 mm
1 x	6.3	1/4		50 mm
1 x	6.3	1/4		100 mm
1 x	-	6.3		150 mm
1 x	-	6.3		150 mm
1 x	-	6.3		176 mm
1 x	-	6.3		29 mm
1 x	8	3/8		30 mm
1 x	6.3	1/4		25 mm

**V6821-L**, EAN 4047728068055

Soft foam insert · empty



**V6822**, EAN 4047728068284

Socket set

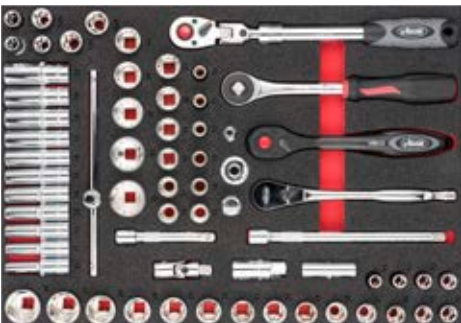

XX	■		Design	Size
6 x	12.5	1/2		E14 · E16 · E18 · E20 · E22 · E24
18 x	12.5	1/2		10 · 11 · 12 · 13 · 14 · 15 · 16 · 17 · 18 · 19 · 20 · 21 · 22 · 23 · 24 · 27 · 30 · 32 mm
11 x	12.5	1/2		10 · 11 · 12 · 13 · 14 · 15 · 16 · 17 · 18 · 19 · 22 mm
2 x	12.5	1/2		16 · 21 mm
17 x	12.5	1/2		10 · 11 · 12 · 13 · 14 · 15 · 16 · 17 · 18 · 19 · 20 · 21 · 22 · 24 · 27 · 30 · 32 mm

XX	■		Design	Size
1 x	12.5	1/2		36 mm
1 x	12.5	1/2		75 mm
1 x	12.5	1/2		125 mm
1 x	12.5	1/2		250 mm
1 x	12.5	1/2		46 mm
1 x	20	3/4		50 mm
1 x	-	12.5		288 mm
1 x	-	12.5		250 mm
1 x	-	12.5		250 mm
1 x	-	12.5		250 mm

**V6822-L**, EAN 4047728068062

Soft foam insert · empty



# Soft foam inserts



**V6809**, EAN 4047728068307  
Screwdriver socket set



XX	■	Design	Size
10 x			T20 · T25 · T27 · T30 · T40 · T45 · T50 · T55 · T60 · T70
10 x			T20 · T25 · T27 · T30 · T40 · T45 · T50 · T55 · T60 · T70
6 x			T40 · T45 · T50 · T55 · T60 · T70
6 x			T40 · T45 · T50 · T55 · T60 · T70

XX	■	Design	Size
9 x			5 · 6 · 7 · 8 · 10 · 12 · 14 · 17 · 19 mm
8 x			5 · 6 · 7 · 8 · 10 · 11 · 12 · 13 mm
7 x			5 · 6 · 7 · 8 · 10 · 12 · 14 mm
6 x			5 · 6 · 7 · 8 · 10 · 12 mm

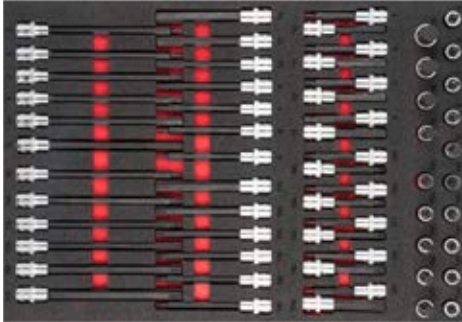

**V6809-L**, EAN 4047728068093  
Soft foam insert · empty



**V6810**, EAN 4047728068413  
Screwdriver socket set



XX	■	Design	Size
9 x			M5 · M6 · M7 · M8 · M9 · M10 · M12 · M13 · M14
9 x			M5 · M6 · M7 · M8 · M9 · M10 · M12 · M13 · M14
7 x			M8 · M9 · M10 · M10.3 · M12 · M13 · M14
7 x			M8 · M9 · M10 · M10.3 · M12 · M13 · M14

XX	■	Design	Size
8 x			M5 · M6 · M8 · M9 · M10 · M12 · M14 · M16
7 x			M5 · M6 · M8 · M9 · M10 · M12 · M14
7 x			M5 · M6 · M8 · M10 · M12 · M14 · M9
4 x			M8 · M10 · M12 · M14

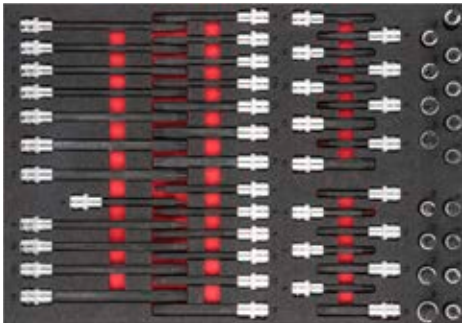

**V6810-L**, EAN 4047728068109  
Soft foam insert · empty



**V6813**, EAN 4047728068444  
Screwdriver set



XX	■	Design	Size
6 x			0.6x3 · 0.8x4 · 1x5.5 · 1.2x6.5 · 1.6x8 · 1.6x10 mm
4 x			PH0 · PH1 · PH2 · PH3
1 x			1x5.5 mm
1 x			PH2

XX	■	Design	Size
7 x			0.6x3.5 · 1x4.5 · 1x5.5 · 1.2x6.5 · 1.6x8 · 1.6x10 · 2x12 mm
3 x			PH1 · PH2 · PH3
11 x			T6 · T7 · T8 · T9 · T10 · T15 · T20 · T25 · T27 · T30 · T40
1 x			0.5x3 mm

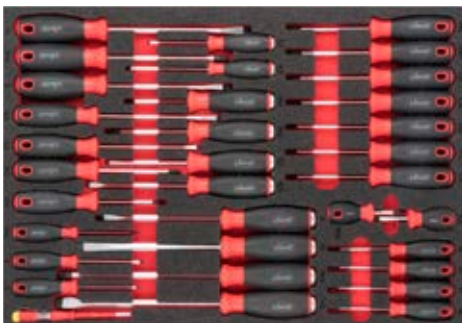

**V6813-L**, EAN 4047728068130  
Soft foam insert · empty



**V6814**, EAN 4047728**068451**

Screwdriver and bit set



XX	■	●	Design	Size
4 x	-	●		1.6 · 2 · 2.4 · 3 mm
2 x	-	●		PH0 · PH00
1 x	-	-		260 mm
1 x	-	-		260 mm
1 x	-	-		260 mm
1 x	-	-		260 mm
1 x	-	-		260 mm
1 x	-	-		130 mm
1 x	-	-		130 mm
1 x	-	-		130 mm
1 x	-	-		130 mm

XX	■	●	Design	Size
5 x	●	●		32 x
5 x	●	●		22 x
3 x	-	●		6 · 7 · 8 mm
9 x	-	●		T10 · T15 · T20 · T25 · T27 · T30 · T40 · T45 · T50
9 x	-	●		1.5 · 2 · 2.5 · 3 · 4 · 5 · 6 · 8 · 10 mm
6 x	-	●		6 · 7 · 8 · 10 · 12 · 13 mm

**V6814-L**, EAN 4047728**068147**

Soft foam insert · empty



**V6817**, EAN 4047728**068499**

Hammer, chisel and drift pin set



XX	Design	Size
1 x		800 g
1 x		1500 g
1 x		∅ 32 mm
1 x		645 mm
1 x		10 x
1 x		210 mm
1 x		10 x
1 x		90 mm

XX	Design	Size
1 x		-
6 x		∅ 3 · 4 · 5 · 6 · 8 · 2 mm
1 x		6 mm
1 x		18 mm
1 x		∅ 4 mm
2 x		190 · 170 mm
2 x		∅ 4 · 40 mm
4 x		10 · 16 · 20 · 29 mm
7 x		∅ 2 · 3 · 4 · 5 · 6 · 7 · 8 mm

**V6817-L**, EAN 4047728**068178**

Soft foam insert · empty



**V6818**, EAN 4047728**068482**

Scraper and release lever set



XX	Design	Size
1 x		165 mm
1 x		5 x
1 x		490 mm
1 x		16 x

XX	Design	Size
1 x		22 mm
1 x		10 x
1 x		4 x
1 x		40 mm

**V6818-L**, EAN 4047728**068185**

Soft foam insert · empty



# Soft foam inserts



**V6811**, EAN 4047728**068420**  
Impact socket set



XX	Design	Size
1 x	6.3 1/4	6.3 1/4
1 x	10 3/8	10 3/8
1 x	12.5 1/2	12.5 1/2
5 x	12.5 1/2	15 · 17 · 19 · 21 · 22 mm
1 x	12.5 1/2	17 mm
1 x	12.5 1/2	19 mm
13 x	12.5 1/2	10 · 11 · 12 · 13 · 14 · 15 · 16 · 17 · 18 · 19 · 21 · 22 · 24 mm

XX	Design	Size
13 x	12.5 1/2	10 · 11 · 12 · 13 · 14 · 15 · 16 · 17 · 18 · 19 · 21 · 22 · 24 mm
8 x	12.5 1/2	T30 · T40 · T45 · T50 · T55 · T60 · T70 · T80
8 x	12.5 1/2	M5 · M6 · M8 · M10 · M12 · M14 · M16 · M18
8 x	12.5 1/2	5 · 6 · 8 · 10 · 12 · 14 · 17 · 19 mm
1 x	12.5 1/2	17 mm
4 x	20 3/4	24 · 30 · 32 · 36 mm

**V6811-L**, EAN 4047728**068116**  
Soft foam insert · empty



**V6812**, EAN 4047728**068437**  
Specialty tools for wheels / tyres



XX	Design	Size
1 x		-
1 x		-
1 x		9 mm
1 x		500 mm
1 x		-

XX	Design	Size
1 x		128 mm
1 x		4 x
1 x		118 mm
1 x		250 mm
1 x		540 mm

**V6812-L**, EAN 4047728**068123**  
Soft foam insert · empty



**V5111N**, EAN 4047728**078733**  
Screwdriver and pliers set



XX	Design	Size
1 x		300 g
1 x		160 mm
6 x		∅ 2 · 3 · 4 · 5 · 6 · 8 mm
1 x		∅ 4 mm
1 x		0,05 – 1,00 mm

XX	Design	Size
2 x		0,6 x 3 – 1,2 x 6,5 · PH0 – PH2
1 x		250 mm
1 x		200 mm
9 x		T10 · T15 · T20 · T25 · T27 · T30 · T40 · T45 · T50
9 x		1,5 · 2 · 2,5 · 3 · 4 · 5 · 6 · 8 · 10 mm

**V5111N-L**, EAN 4047728**077996**  
Soft foam insert · empty



**V5634N**, EAN 4047728078757

Hammer, pliers and screwdriver set



XX	Design	Size
1 x		-
1 x		250 mm
1 x		300 g
1 x		Ø 32 mm
1 x		160 mm

XX	Design	Size
1 x		200 mm
1 x		Ø 4 mm
6 x		Ø 2 · 3 · 4 · 5 · 6 · 8 mm
1 x		0,05 - 1,00 mm
2 x		0,6 x 3 - 1,2 x 6,5 · PH0 - PH2

**V5634N-L**, EAN 4047728078016

Soft foam insert · empty



**V5636N**, EAN 4047728078764

Pliers and hammer set



XX	Design	Size
1 x		40 mm
1 x		340 mm
1 x		200 mm
1 x		180 mm
1 x		160 mm

XX	Design	Size
3 x		230 · 180 · 140 mm
3 x		230 · 140 · 180 mm
1 x		Ø 40 mm
1 x		800 g
1 x		22 mm
1 x		10 x
1 x		250 mm

**V5636N-L**, EAN 4047728078030

Soft foam insert · empty



**V5637N**, EAN 4047728078771

Pliers, hammer and chisel set



XX	Design	Size
1 x		0,05 - 1,00 mm
1 x		180 mm
1 x		180 mm
1 x		180 mm
1 x		180 mm
1 x		180 mm
1 x		Ø 4 mm
6 x		Ø 2 · 3 · 4 · 5 · 6 · 8 mm

XX	Design	Size
1 x		18 mm
1 x		6 mm
1 x		180 mm
1 x		160 mm
1 x		Ø 32 mm
1 x		300 g
1 x		22 mm
1 x		250 mm
1 x		-

**V5637N-L**, EAN 4047728078047

Soft foam insert · empty





# Soft foam inserts



**V6565**, EAN 4047728**085403**

Pliers set

**NEW**



XX	Design	Size
1 x		180 mm
1 x		140 mm
1 x		200 mm
1 x		250 mm
1 x		290 mm
1 x		300 mm

XX	Design	Size
1 x		340 mm
1 x		340 mm
1 x		335 mm
1 x		125 mm
1 x		190 mm
1 x		200 mm



**V6565-L**, EAN 4047728**085366**

Soft foam insert L · empty



**V6640**, EAN 4047728**085588**

Combination wrench set



XX	Design	Size
6 x		34 · 36 · 38 · 41 · 46 · 50 mm



**V6640-L**, EAN 4047728**085571**

Soft foam insert L · empty



**V6643N**, EAN 4047728**084796**

Wrench set · L

**NEW**



XX	Design	Size
9 x		6 x 7 · 8 x 9 · 10 x 11 · 12 x 13 · 14 x 15 · 16 x 17 · 18 x 19 · 20 x 22 · 21 x 23 mm
17 x		6 · 7 · 8 · 9 · 10 · 11 · 12 · 13 · 14 · 15 · 16 · 17 · 18 · 19 · 22 · 24 · 27 mm

XX	Design	Size
10 x		6 x 7 · 8 x 9 · 10 x 11 · 12 x 13 · 14 x 15 · 16 x 17 · 18 x 19 · 20 x 22 · 21 x 23 · 24 x 27 mm

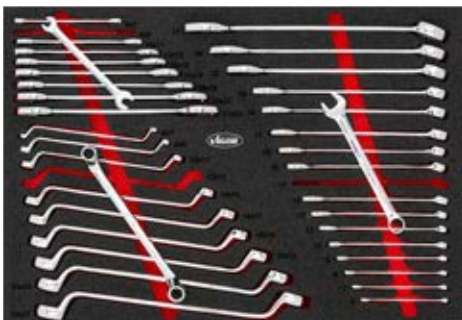

**V6643N-L**, EAN 4047728**084710**

Wrench insert, empty · L



**V6724N**, EAN 4047728**084840**  
 Double open-end wrench, combination wrench, ratcheting combination wrench set

**NEW**

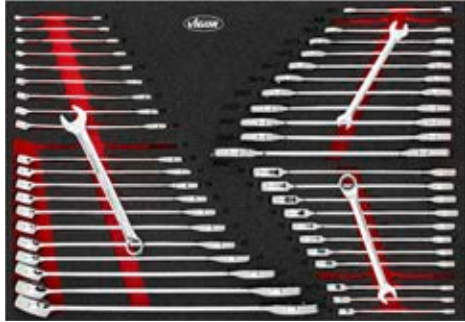

XX	Design	Size
12 x		8 · 9 · 10 · 11 · 12 · 13 · 14 · 15 · 16 · 17 · 18 · 19 mm
12 x		6 x 7 · 8 x 9 · 10 x 11 · 12 x 13 · 14 x 15 · 16 x 17 · 18 x 19 · 20 x 22 · 21 x 23 · 24 x 27 · 25 x 28 · 30 x 32 mm

XX	Design	Size
21 x		6 · 7 · 8 · 9 · 10 · 11 · 12 · 13 · 14 · 15 · 16 · 17 · 18 · 19 · 20 · 21 · 22 · 24 · 27 · 30 · 32 mm

**V6724N-L**, EAN 4047728**084581**  
 Wrench insert, empty · L



**V6726N**, EAN 4047728**084826**  
 Double open-end, double box-end and combination wrench set

**NEW**

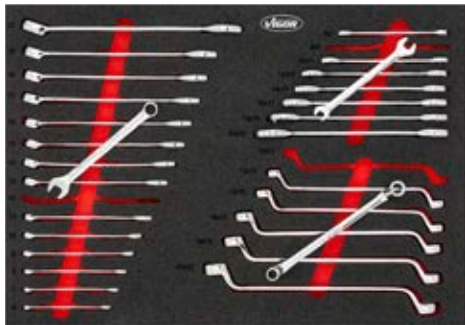

XX	Design	Size
8 x		6 x 7 · 8 x 9 · 10 x 11 · 12 x 13 · 14 x 15 · 16 x 17 · 18 x 19 · 20 x 22 mm
15 x		6 · 7 · 8 · 9 · 10 · 11 · 12 · 13 · 14 · 15 · 16 · 17 · 18 · 19 · 22 mm

XX	Design	Size
6 x		10 x 11 · 12 x 13 · 14 x 15 · 16 x 17 · 18 x 19 · 20 x 22 mm

**V6726N-L**, EAN 4047728**084628**  
 Wrench insert, empty · L



**V6807N**, EAN 4047728**084857**  
 Ratcheting combination wrench set

**NEW**

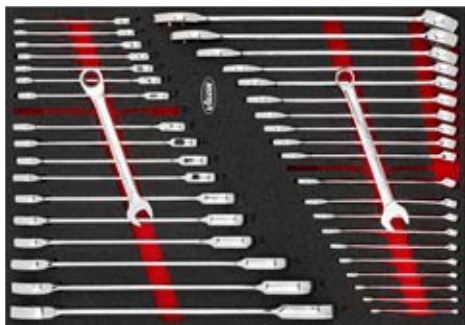

XX	Design	Size
18 x		8 · 9 · 10 · 11 · 12 · 13 · 14 · 15 · 16 · 17 · 18 · 19 · 21 · 22 · 24 · 27 · 30 · 32 mm

XX	Design	Size
22 x		6 · 7 · 8 · 9 · 10 · 11 · 12 · 14 · 13 · 15 · 16 · 17 · 18 · 19 · 20 · 21 · 22 · 24 · 27 · 30 · 32 · 36 mm

**V6807N-L**, EAN 4047728**084574**  
 Wrench insert, empty · L



# Soft foam inserts



**V6808N**, EAN 4047728**084772**

Double box-end and open-end wrench set

**NEW**



XX	Design	Size
12 x		6 x 7 · 8 x 9 · 10 x 11 · 12 x 13 · 14 x 15 · 16 x 17 · 18 x 19 · 20 x 22 · 21 x 23 · 24 x 27 · 25 x 28 · 30 x 32 mm

XX	Design	Size
12 x		6 x 7 · 8 x 9 · 10 x 11 · 12 x 13 · 14 x 15 · 16 x 17 · 18 x 19 · 20 x 22 · 21 x 23 · 24 x 27 · 25 x 28 · 30 x 32 mm



**V6808N-L**, EAN 4047728**084567**

Wrench insert, empty · L



**V6816N**, EAN 4047728**078801**

Pliers set



XX	Design	Size
1 x		150 mm
1 x		250 mm
1 x		125 mm
1 x		11 - 19 mm
1 x		16 - 27 mm

XX	Design	Size
3 x		140 · 180 · 230 mm
3 x		140 · 180 · 230 mm
3 x		140 · 180 · 230 mm
3 x		140 · 180 · 230 mm

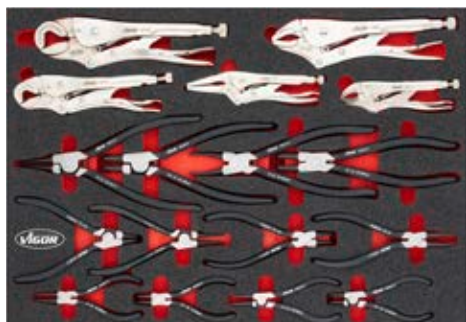

**V6816N-L**, EAN 4047728**078078**

Soft foam insert · empty



**V4586**, EAN 4047728**045865**  
**Socket tool set for series XL**



XX	Size	Design	Size	XX	Size	Design	Size
5 x	6.3 1/4		R5 · R6 · R7 · R8 · R9	4 x	6.3 1/4		3 · 4 · 5 · 6 mm
3 x	6.3 1/4		T5 · T6 · T7	3 x	6.3 1/4		PH0 · PH1 · PH2
3 x	6.3 1/4		M5 · M6 · M8	3 x	6.3 1/4		PZ0 · PZ1 · PZ2
9 x	6.3 1/4		T7H · T10H · T15H · T20H · T25H · T27H · T30H · T40H · T45H	4 x	6.3 1/4		0.8x4 · 1x5.5 · 1.2x6.5 · 1.2x7 mm
6 x	8 3/8		T40 · T45 · T50 · T55 · T60 · T70	7 x	6.3 1/4		T9H · T10H · T15H · T20H · T25H · T27H · T30H
5 x	8 3/8		7 · 8 · 10 · 12 · 14 mm	10 x	10 3/8		10 · 11 · 12 · 13 · 14 · 15 · 16 · 17 · 18 · 19 mm
2 x	8 3/8		PH3 · PH4	6 x	10 3/8		10 · 11 · 12 · 13 · 14 · 15 mm
2 x	8 3/8		PZ3 · PZ4	6 x	10 3/8		E10 · E11 · E12 · E14 · E16 · E18
3 x	8 3/8		1.6x8 · 1.6x10 · 2x12 mm	17 x	12.5 1/2		10 · 11 · 12 · 13 · 14 · 15 · 16 · 17 · 18 · 19 · 20 · 21 · 22 · 24 · 27 · 30 · 32 mm
6 x	8 3/8		T40H · T45H · T50H · T55H · T60H · T70H	5 x	12.5 1/2		16 · 17 · 18 · 19 · 22 mm
2 x	-		1.3 · 2 mm	2 x	12.5 1/2		E20 · E24
1 x	10 3/8		28 mm	13 x	6.3 1/4		4 · 4.5 · 5 · 5.5 · 6 · 7 · 8 · 9 · 10 · 11 · 12 · 13 · 14 mm
1 x	6.3 1/4		25 mm	7 x	6.3 1/4		4 · 5 · 6 · 7 · 8 · 9 · 10 mm
1 x	12.5 1/2		37 mm	5 x	6.3 1/4		E4 · E5 · E6 · E7 · E8
1 x	6.3 1/4		25 mm	1 x	-		150 mm
1 x	6.3 1/4		110 mm	1 x	-		198 mm
1 x	-		150 mm	1 x	-		250 mm
1 x	-		43.7 mm	1 x	6.3 1/4		40 mm
8 x	12.5 1/2		T20 · T25 · T27 · T30 · T40 · T45 · T50 · T55	1 x	10 3/8		50 mm
8 x	12.5 1/2		T27 · T30 · T40 · T45 · T50 · T55 · T60 · T70	1 x	12.5 1/2		75 mm
8 x	12.5 1/2		M5 · M6 · M8 · M9 · M10 · M14 · M16 · M12	1 x	6.3 1/4		50 mm
7 x	12.5 1/2		M5 · M6 · M8 · M9 · M10 · M12 · M14	1 x	6.3 1/4		100 mm
8 x	12.5 1/2		5 · 6 · 7 · 8 · 10 · 12 · 14 · 17 mm	1 x	10 3/8		125 mm
8 x	12.5 1/2		5 · 6 · 7 · 8 · 10 · 11 · 12 · 13 mm	1 x	12.5 1/2		125 mm
7 x	6.3 1/4		T9 · T10 · T15 · T20 · T25 · T27 · T30	1 x	12.5 1/2		250 mm
				1 x	10 3/8		18 mm
				2 x	12.5 1/2		16 · 21 mm

**V4521**, EAN 4047728**045216**  
**Soft foam insert · empty**



**V6831**, EAN 4047728**082280**  
**Torque wrench insert including 40–200 Nm torque wrench**



XX	Size	Design	Size
1 x	12.5 1/2		540 mm



**V6831-L**, EAN 4047728**082242**  
**Soft foam insert · empty**



# Soft foam inserts



**V5170**, EAN 4047728051712  
Screwdriver set for series XL



XX	Design	Size
4 x		1.6 · 2 · 2.4 · 3 mm
2 x		PH0 · PH00
11 x		T6 · T7 · T8 · T9 · T10 · T15 · T20 · T25 · T27 · T30 · T40
4 x		PH0 · PH1 · PH2 · PH3
3 x		PH1 · PH2 · PH3
1 x		PH2
5 x		0.6x3 · 0.8x4 · 1x5.5 · 1.6x8 · 1.6x10 mm

XX	Design	Size
4 x		0.6x3.5 · 1x4.5 · 1x5.5 · 1.2x6.5 mm
1 x		1x5.5 mm
9 x		T10 · T15 · T20 · T25 · T27 · T30 · T40 · T45 · T50
9 x		1.5 · 2 · 2.5 · 3 · 4 · 5 · 6 · 8 · 10 mm
6 x		6 · 7 · 8 · 10 · 12 · 13 mm
1 x		0.5x3 mm



**V5170-L**, EAN 4047728051729  
Soft foam insert · empty



**V5638N**, EAN 4047728078788  
Pliers, hammer and chisel set for series XL



XX	Design	Size
1 x		1000 g
1 x		∅ 32 mm
1 x		22 mm
6 x		∅ 2 · 3 · 4 · 5 · 6 · 8 mm
1 x		∅ 4 mm
1 x		18 mm
1 x		6 mm
1 x		40 mm
1 x		10 x
1 x		150 mm

XX	Design	Size
1 x		335 mm
1 x		340 mm
1 x		1500 g
1 x		165 mm
1 x		160 mm
1 x		180 mm
1 x		200 mm
1 x		250 mm
3 x		140 · 180 · 230 mm
3 x		140 · 180 · 230 mm



**V5638N-L**, EAN 4047728078054  
Soft foam insert · empty



**V6015**, EAN 4047728**074667**

Impact socket set with impact wrench for series XL



XX	Design	Size
1 x		17 mm
1 x		19 mm
1 x		21 mm
1 x		540 mm
1 x		118 mm
13 x		10 · 11 · 12 · 13 · 14 · 15 · 16 · 17 · 18 · 19 · 21 · 22 · 24 mm

XX	Design	Size
13 x		10 · 11 · 12 · 13 · 14 · 15 · 16 · 17 · 18 · 19 · 21 · 22 · 24 mm
5 x		15 · 17 · 19 · 21 · 22 mm
8 x		5 · 6 · 8 · 10 · 12 · 14 · 17 · 19 mm
8 x		M5 · M6 · M8 · M10 · M12 · M14 · M16 · M18
8 x		T30 · T40 · T45 · T50 · T55 · T60 · T70 · T80

**V6015-L**, EAN 4047728**074056**

Soft foam insert · empty



**V6650N**, EAN 4047728**084833**

Combination wrench, double box-end wrench, double open-end wrench set for series XL

**NEW**

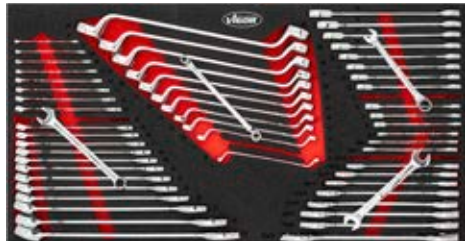

XX	Design	Size
12 x		6 x 7 · 8 x 9 · 10 x 11 · 12 x 13 · 14 x 15 · 16 x 17 · 18 x 19 · 20 x 22 · 21 x 23 · 24 x 27 · 25 x 28 · 30 x 32 mm
12 x		6 x 7 · 8 x 9 · 10 x 11 · 12 x 13 · 14 x 15 · 16 x 17 · 18 x 19 · 20 x 22 · 21 x 23 · 24 x 27 · 25 x 28 · 30 x 32 mm

XX	Design	Size
12 x		8 · 9 · 10 · 11 · 12 · 13 · 14 · 15 · 16 · 17 · 18 · 19 mm
22 x		6 · 7 · 8 · 9 · 10 · 11 · 12 · 13 · 14 · 15 · 16 · 17 · 18 · 19 · 20 · 21 · 22 · 24 · 27 · 30 · 32 · 36 mm

**V6650N-L**, EAN 4047728**084550**

Wrench insert, empty · XL



**V7015N**, EAN 4047728**078818**

Pliers and scraper set for series XL



XX	Design	Size
1 x		800 g
1 x		300 mm
1 x		335 mm
1 x		340 mm
1 x		10 x
1 x		90 mm
1 x		165 mm
1 x		290 mm

XX	Design	Size
1 x		16 x
7 x		∅ 2 · 3 · 4 · 5 · 6 · 7 · 8 mm
2 x		∅ 4 · 40 mm
4 x		10 · 16 · 20 · 29 mm
2 x		170 · 190 mm
1 x		180 mm
1 x		200 mm
1 x		250 mm

**V7015N-L**, EAN 4047728**078085**

Soft foam insert · empty



# Soft foam inserts



**V5009**, EAN 4047728050098  
2-component soft foam insert ·  
with empty compartment

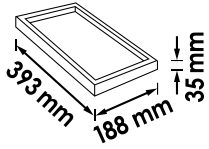

**V4631**, EAN 4047728046312  
2-component soft foam  
insert · without cut-out

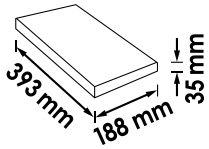

**V5018**, EAN 4047728050180  
2-component soft foam insert ·  
with empty compartment

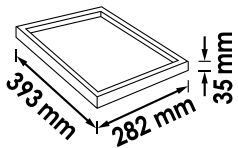

**V4632**, EAN 4047728046329  
2-component soft foam  
insert · without cut-out

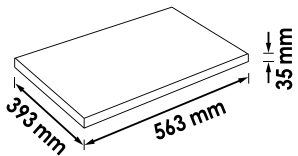

**V4633**, EAN 4047728064347  
2-component soft foam  
insert · without cut-out

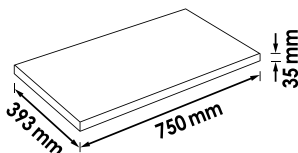



## Hand tools: precision in your hand

No professional without the right tools! Our hand tools are specially designed to offer precision and durability – so you can give your best every time you use them. Whether screwdrivers, pliers, hammers or saws – every tool in our assortment fulfils the highest quality standards and is ready to master the challenges of your projects.

We know how important reliability and accuracy are – which is why we only offer hand tools that are made from high-quality materials. These tools are not only comfortable to hold – but are also designed to reduce fatigue and increase efficiency in the workplace.

Browse through our versatile selection and equip yourself with tools that work as hard as you do. Whether for fine detail work or rough power applications – our hand tools will help you tackle any project with confidence and precision.



# Hand tools

Sockets 120–168

Universal tool cases 169–170

Wrenches 171–179

Screwdrivers and bits 180–192

Pliers 193–200

VDE tools 201–204

Impact and releasing tools, scrapers 205–212

Various hand tools 212–213

Cutting and sawing 213–219



**V5202**, EAN 4047728**068987**

## Socket set · super flat

- Flat insert profile – Direct attachment to the nut/screw connection
- Robust solid steel reversible ratchet
- Right and left-hand operation
- Ergonomic handle
- Sockets without chamfered edge
- Super short sockets make it possible to work in very tight spaces
- Through-hole sockets make it possible to work on stud bolts
- Sockets with outside hexagon size 11 mm for operation with box-end wrench or open-end wrench
- For manual operation

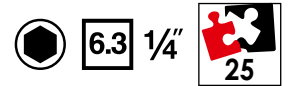

Including  
bit holder and bits

XX	■	●	Design	Size
3 x	6.3 1/4	●		0.8 x 4 · 1 x 5 · 1 x 6 mm
2 x	6.3 1/4	●		PH1 · PH2
5 x	6.3 1/4	●		T15 · T20 · T25 · T27 · T30
1 x	-	6.3 1/4		-
1 x	6.3 1/4	6.3 1/4		-
13 x	6.3 1/4	●		4 · 4.5 · 5 · 5.5 · 6 · 7 · 8 · 9 · 10 · 11 · 12 · 13 · 14 mm

**V3734N**, EAN 4047728**056427**

## Socket set

- For manual operation



Single parts from page 122

XX	■	●	Design	Size
2 x	6.3 1/4	●		PH1 · PH2
2 x	6.3 1/4	●		PZ1 · PZ2
4 x	6.3 1/4	●		T15 · T20 · T25 · T30
1 x	6.3 1/4	6.3 1/4		25 mm
12 x	6.3 1/4	●		4 · 4.5 · 5 · 5.5 · 6 · 7 · 8 · 9 · 10 · 11 · 12 · 13 mm
1 x	-	6.3 1/4		150 mm
1 x	6.3 1/4	6.3 1/4		100 mm

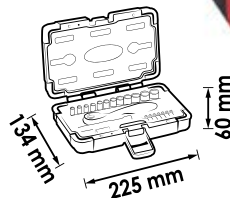

# Sockets



**V2414N**, EAN 4047728**056434**

## Socket set

• For manual operation



Single parts from page 122

XX	■	●	Design	Size
13 x	6.3 1/4	●		4 · 4.5 · 5 · 5.5 · 6 · 7 · 8 · 9 · 10 · 11 · 12 · 13 · 14 mm
3 x	6.3 1/4	●		0.8x4 · 1x5.5 · 1.2x7 mm
6 x	6.3 1/4	●		3 · 4 · 5 · 6 · 7 · 8 mm
3 x	6.3 1/4	+		PH1 · PH2 · PH3
3 x	6.3 1/4	+		PZ1 · PZ2 · PZ3
6 x	6.3 1/4	●		T10 · T15 · T20 · T25 · T30 · T40
2 x	-	○		1.3 · 2 mm
1 x	10 3/8	6.3 1/4		27 mm
1 x	6.3 1/4	6.3 1/4		110 mm
1 x	6.3 1/4	6.3 1/4		50 mm
1 x	6.3 1/4	6.3 1/4		100 mm
1 x	6.3 1/4	6.3 1/4		145 mm
1 x	6.3 1/4	6.3 1/4		40 mm
1 x	-	6.3 1/4		150 mm
1 x	-	6.3 1/4		150 mm

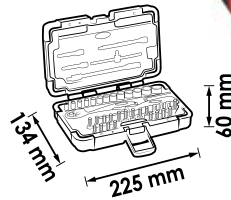

**V7514/13**, EAN 4047728**074063**

## 12-point socket set

• For manual operation

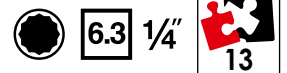

Single parts from page 125

XX	■	●	Design	Size
13 x	6.3 1/4	●		4 · 4.5 · 5 · 5.5 · 6 · 7 · 8 · 9 · 10 · 11 · 12 · 13 · 14 mm



**V1897**, EAN 4047728018975

## Socket set with multi-purpose profile

- For manual operation

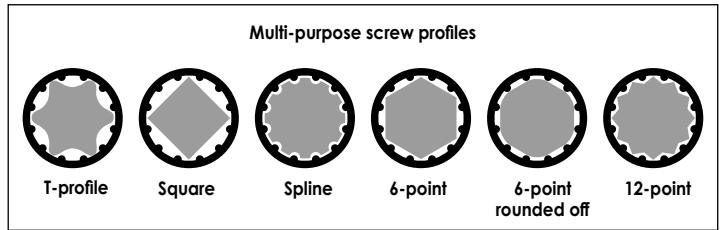
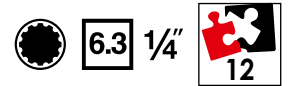

Single parts from page 126

XX	■	●	Design	Size
12 x	6.3 1/4"			4 · 5 · 5.5 · 6 · 7 · 8 · 9 · 10 · 11 · 12 · 13 · 14 mm



All sockets suitable for 6 different profiles



**V6014**, EAN 4047728055833

## Fine-tooth reversible ratchet

- Offset design
- Plastic coating
- Quick-release press-button
- 72 teeth
- Opening angle: 5°
- For manual operation

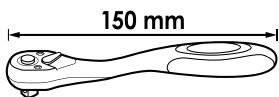

6.3 1/4"

**V6014-REP**, EAN 4047728056519

## Repair set

- Repair set for fine-tooth reversible ratchet V6014



**V4944-S**, EAN 4047728055345

## Fine-tooth reversible ratchet · standard

- Robust and service-friendly
- Closed system
- Easy to clean
- 72 teeth
- Opening angle: 5°
- For manual operation

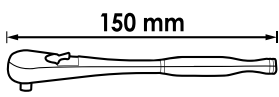

6.3 1/4"

**V4944-REP**, EAN 4047728049474

## Repair set

- Repair set for fine-tooth reversible ratchets V4944 · V4944-S · V4944-XS



# Sockets



**V4944-XS**, EAN 4047728069557

**Fine-tooth reversible ratchet · extra-short design**

- Robust and service-friendly
- Closed system
- Easy to clean
- 72 teeth
- Opening angle: 5°
- For manual operation



6.3 1/4"

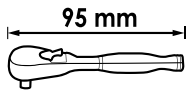

6.3 1/4"



**V5436**, EAN 4047728054362

**360° rotary handle reversible ratchet**

- Use in areas with restricted access
- Sliding square for clockwise/anti-clockwise operation
- Standard operation also possible through bolting
- Operation only clockwise
- 72 teeth
- Opening angle: 5°
- For manual operation

*Loosening and tightening of screw connections only in locked mode*

6.3 1/4"

Actuator mechanism in the 360° rotary handle

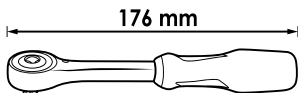

6.3 1/4"



**V6614N**, EAN 4047728080354

**Telescopic reversible ratchet with hinge joint**

- Telescopic range 175 – 225 mm
- 180° swivel head with locking mechanism
- Quick-release press-button
- 90 teeth
- Opening angle: 4°
- For manual operation

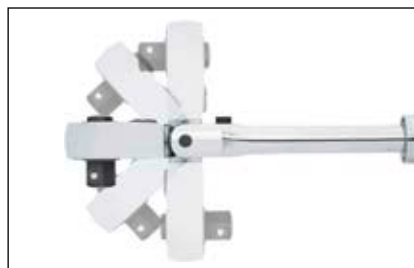

Latches in 5 positions

6.3 1/4"

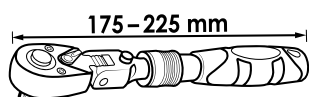

**V6614N-REP**, EAN 4047728081757

**Repair set**

- Repair set for telescopic reversible ratchet with hinge joint V6614N



**V2941**, EAN 4047728**029414**

**6.3** 1/4" 6.3 1/4"

## Finger ratchet

- Finger ratchet, individual, for screwdriver bits
- 72 teeth
- Opening angle: 5°
- For manual operation

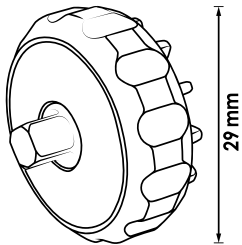

**V2458N**, EAN 4047728**058179**

**6.3** 1/4"

## Spin type speeder

- For manual operation



**V2453N**, EAN 4047728**058124**

**6.3** 1/4" 6.3 1/4"

## Sliding T-handle

- For manual operation



## 6-point socket

**6.3** 1/4"



VIGOR No.	Size	L mm	EAN 4047728+
<b>V2413N</b>	4 mm	25	<b>057738</b>
<b>V2415N</b>	4.5 mm	25	<b>057745</b>
<b>V2416N</b>	5 mm	25	<b>057752</b>
<b>V2417N</b>	5.5 mm	25	<b>057769</b>
<b>V2418N</b>	6 mm	25	<b>057776</b>
<b>V2419N</b>	7 mm	25	<b>057783</b>
<b>V2420N</b>	8 mm	25	<b>057790</b>

VIGOR No.	Size	L mm	EAN 4047728+
<b>V2421N</b>	9 mm	25	<b>057806</b>
<b>V2422N</b>	10 mm	25	<b>057813</b>
<b>V2423N</b>	11 mm	25	<b>057820</b>
<b>V2424N</b>	12 mm	25	<b>057837</b>
<b>V2425N</b>	13 mm	25	<b>057844</b>
<b>V2426N</b>	14 mm	25	<b>057851</b>

# Sockets



## 12-point socket



VIGOR No.	Size	mm	EAN 4047728+
V7514-4	4 mm	25	074070
V7514-4.5	4.5 mm	25	074087
V7514-5	5 mm	25	074094
V7514-5.5	5.5 mm	25	074100
V7514-6	6 mm	25	074117
V7514-7	7 mm	25	074124
V7514-8	8 mm	25	074131

VIGOR No.	Size	mm	EAN 4047728+
V7514-9	9 mm	25	074148
V7514-10	10 mm	25	074155
V7514-11	11 mm	25	074162
V7514-12	12 mm	25	074179
V7514-13	13 mm	25	074186
V7514-14	14 mm	25	074193

## 6-point socket · long



VIGOR No.	Size	mm	EAN 4047728+
V2533N	4 mm	50	058193
V2534N	5 mm	50	058209
V2535N	6 mm	50	058216
V2536N	7 mm	50	058223
V2537N	8 mm	50	058230

VIGOR No.	Size	mm	EAN 4047728+
V2538N	9 mm	50	058247
V2539N	10 mm	50	058254
V2699N	11 mm	50	058735
V2700N	12 mm	50	058742
V2701N	13 mm	50	058759

## 12-point socket · long



VIGOR No.	Size	EAN 4047728+
V7514L-4	4 mm	080514
V7514L-5	5 mm	080521
V7514L-5.5	5.5 mm	080538
V7514L-6	6 mm	080545
V7514L-7	7 mm	080552
V7514L-8	8 mm	080569

VIGOR No.	Size	EAN 4047728+
V7514L-9	9 mm	080576
V7514L-10	10 mm	080583
V7514L-11	11 mm	080590
V7514L-12	12 mm	080606
V7514L-13	13 mm	080613

## T socket

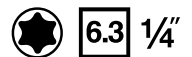

VIGOR No.	Size	mm	EAN 4047728+
V2185N	E4	25	084888
V2186N	E5	25	084895
V2187N	E6	25	084901
V2188N	E7	25	084918
V2189N	E8	25	084925
V2722N	E10	25	084932
V2723N	E11	25	084949

## T socket · long

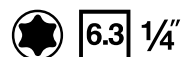

VIGOR No.	Size	mm	EAN 4047728+
V7014-4	E4	50	083454
V7014-5	E5	50	083478
V7014-6	E6	50	083485
V7014-7	E7	50	083492
V7014-8	E8	50	083508

## T-Plus socket



VIGOR No.	Size	EAN 4047728+
V7920-EP4	E4+	078146
V7920-EP5	E5+	078153
V7920-EP6	E6+	078160
V7920-EP7	E7+	078177
V7920-EP8	E8+	078184

## Socket with multi-purpose profile



VIGOR No.	Size	L mm	EAN 4047728+
V1976	4 mm	25	019767
V1977	5 mm	25	019774
V1978	5.5 mm	25	019781
V1979	6 mm	25	019798
V1980	7 mm	25	019804
V1981	8 mm	25	019811

VIGOR No.	Size	L mm	EAN 4047728+
V1982	9 mm	25	019828
V1983	10 mm	25	019835
V1984	11 mm	25	019842
V1985	12 mm	25	019859
V1986	13 mm	25	019866
V1987	14 mm	25	019873

## T screwdriver socket

**NEW**



VIGOR No.	Size	L mm	EAN 4047728+
V2192N	T8	37	085229
V2595N	T9	38	058599
V2442N	T10	38	058018
V2443N	T15	38	058025
V2444N	T20	38	058032

VIGOR No.	Size	L mm	EAN 4047728+
V2445N	T25	38	058049
V2130N	T27	38	057042
V2446N	T30	38	058056
V2447N	T40	38	058063

## T-Plus screwdriver socket



VIGOR No.	Size	EAN 4047728+
V7037-IP8	T8+	078276
V7037-IP10	T10+	078283
V7037-IP15	T15+	078290
V7037-IP20	T20+	078306
V7037-IP25	T25+	078313
V7037-IP27	T27+	078320
V7037-IP30	T30+	078337

## T screwdriver socket

**NEW**



VIGOR No.	Size	L mm	EAN 4047728+
V7037-T8H	T8H	37	082310
V2596N	T9H	37	058605
V2136N	T10H	37	085236
V2138N	T15H	32	085243

VIGOR No.	Size	L mm	EAN 4047728+
V2139N	T20H	32	085250
V2140N	T25H	37	085267
V2141N	T27H	37	085274
V2142N	T30H	37	085281



## T-Plus screwdriver socket



6.3 1/4"

VIGOR No.	Size	EAN 4047728+
V7037-IPR8	T8+H	078399
V7037-IPR10	T10+H	078405
V7037-IPR15	T15+H	078412
V7037-IPR20	T20+H	078429
V7037-IPR25	T25+H	078436
V7037-IPR27	T27+H	078443
V7037-IPR30	T30+H	078450

## Screwdriver socket



6.3 1/4"

VIGOR No.	Size	mm	EAN 4047728+
V2593N	PH0	38	058575
V2436N	PH1	38	057950
V2437N	PH2	38	057967
V2438N	PH3	38	057974

## Screwdriver socket



6.3 1/4"

VIGOR No.	Size	mm	EAN 4047728+
V2594N	PZ0	38	058582
V2439N	PZ1	38	057981
V2440N	PZ2	38	057998
V2441N	PZ3	38	058001

## Screwdriver socket



6.3 1/4"

VIGOR No.	Size	mm	EAN 4047728+
V2427N	0.8x4 mm	38	057868
V2428N	1x5.5 mm	38	057875
V2597N	1.2x6.5 mm	38	058612
V2429N	1.2x7 mm	38	057882

## Screwdriver socket for inside hexagon screws



6.3 1/4"

VIGOR No.	Size	mm	EAN 4047728+
V2430N	3 mm	38	057899
V2431N	4 mm	38	057905
V2432N	5 mm	38	057912
V2433N	6 mm	38	057929
V2434N	7 mm	38	057936
V2435N	8 mm	38	057943

## Flexible extension

6.3 1/4" 6.3 1/4"



VIGOR No.	mm	EAN 4047728+
V2457N	145	058162

## Wobble extension

- Operating screw connections in confined spaces and working in areas with restricted access
- Spherical, tapered outside square

6.3 1/4" 6.3 1/4"



VIGOR No.	mm	EAN 4047728+
V4311	36	043113
V4312	75	043120
V4313	250	043137

## Extension

6.3 1/4" 6.3 1/4"



VIGOR No.	mm	EAN 4047728+
V2455N	50	058148
V2456N	100	058155

## Universal joint



**6.3** 1/4" **6.3** 1/4"

VIGOR No.	mm	EAN 4047728+
<b>V2454N</b>	40	058131

## Adapter



**10** 3/8" **6.3** 1/4"

VIGOR No.	mm	EAN 4047728+
<b>V2014</b>	26	020145

## Adapter



**6.3** 1/4" **6.3** 1/4"

VIGOR No.	mm	EAN 4047728+
<b>V2452N</b>	25	058117

## Bit adapter



**6.3** 1/4" **6.3** 1/4"

VIGOR No.	mm	EAN 4047728+
<b>V3651N</b>	25	058872



**V2305N**, EAN 4047728**056441**

**Socket set**

• For manual operation

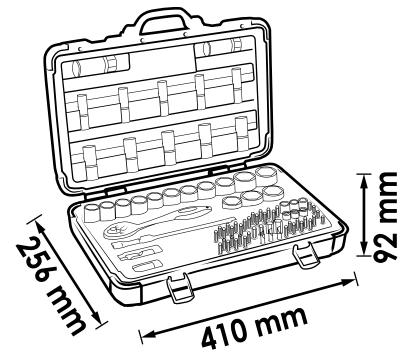

Single parts from page 133

xx	■		Design	Size
18 x	10 3/8	●		6 · 7 · 8 · 9 · 10 · 11 · 12 · 13 · 14 · 15 · 16 · 17 · 18 · 19 · 20 · 21 · 22 · 24 mm
10 x	10 3/8	●		8 · 9 · 10 · 11 · 12 · 13 · 14 · 15 · 17 · 19 mm
2 x	10 3/8	●		16 · 21 mm
7 x	10 3/8	○		3 · 4 · 5 · 6 · 7 · 8 · 10 mm
3 x	10 3/8	◐		0.8x5.5 · 1x7 · 1.2x8 mm
3 x	10 3/8	+		PH1 · PH2 · PH3
3 x	10 3/8	+		PZ1 · PZ2 · PZ3
9 x	10 3/8	⊛		T15 · T20 · T25 · T27 · T30 · T40 · T45 · T50 · T55
1 x	10 3/8	⊛		28 mm
1 x	12 3/8 1/2	10 3/8		40 mm
1 x	10 3/8	10 3/8		75 mm
1 x	10 3/8	10 3/8		250 mm
1 x	10 3/8	10 3/8		50 mm
1 x	-	10 3/8		198 mm



# Sockets



**V7538/10**, EAN 4047728074209

## 12-point socket set

- For manual operation

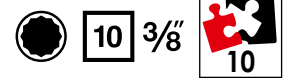

Single parts from page 133

XX	■	●	Design	Size
10 x	10 3/8	●		10 · 11 · 12 · 13 · 14 · 15 · 16 · 17 · 18 · 19 mm



**V6017**, EAN 4047728064361

## T screwdriver socket set

- Phosphatized blades
- Chrome-vanadium steel
- Knurling
- For manual operation

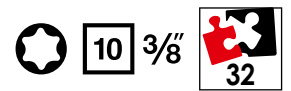

Single parts from page 135

XX	■	●	Design	Size
8 x	10 3/8	●		T20 · T25 · T27 · T30 · T40 · T45 · T50 · T55
2 x	10 3/8	●		T60 · T70
10 x	10 3/8	●		T20 · T25 · T27 · T30 · T40 · T45 · T50 · T55 · T60 · T70
6 x	10 3/8	●		T40 · T45 · T50 · T55 · T60 · T70
6 x	10 3/8	●		T40 · T45 · T50 · T55 · T60 · T70



**V6018**, EAN 4047728065894

## Screwdriver socket set for screws with internal serration (XZN)

- Phosphatized blades
- Chrome-vanadium steel
- Knurling
- For manual operation

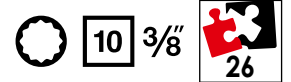

Single parts from page 137

XX	■	●	Design	Size
8 x	10 3/8	○		M5 · M6 · M8 · M9 · M10 · M12 · M14 · M16
7 x	10 3/8	○		M5 · M6 · M8 · M9 · M10 · M12 · M14
7 x	10 3/8	○		M5 · M6 · M8 · M9 · M10 · M12 · M14
4 x	10 3/8	○		M8 · M10 · M12 · M14



**V6019**, EAN 4047728065900

## Screwdriver socket set for inside hexagon screws

- Phosphatized blades
- Chrome-vanadium steel
- Knurling
- For manual operation

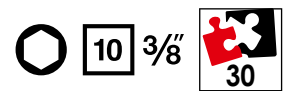

Single parts from page 138

XX	■	●	Design	Size
9 x	10 3/8	○		5 · 6 · 7 · 8 · 10 · 12 · 14 · 17 · 19 mm
8 x	10 3/8	○		5 · 6 · 7 · 8 · 10 · 11 · 12 · 13 mm
7 x	10 3/8	○		5 · 6 · 7 · 8 · 10 · 12 · 14 mm
6 x	10 3/8	○		5 · 6 · 7 · 8 · 10 · 12 mm



**V6038**, EAN 4047728055840

## Fine-tooth reversible ratchet

- Offset design
- Plastic coating
- Quick-release press-button
- DIN 3122, ISO 3315
- 72 teeth
- Opening angle: 5°
- For manual operation



10 3/8

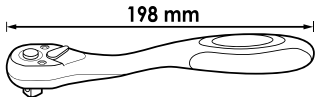

10 3/8



**V6038-REP**, EAN 4047728056526

## Repair set

- Repair set for fine-tooth reversible ratchet V6038



10 3/8



**V6638N**, EAN 4047728080347

## Telescopic reversible ratchet with hinge joint

- Telescopic range 250 – 350 mm
- 180° swivel head with locking mechanism
- Quick-release press-button
- 90 teeth
- Opening angle: 4°
- For manual operation



10 3/8

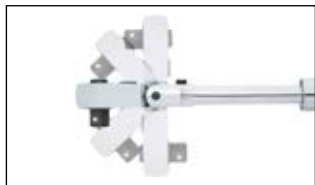
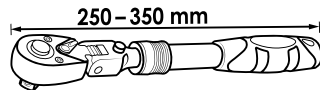

Latches in 5 positions



**V6638N-REP**, EAN 4047728081740

## Repair set

- Repair set for telescopic reversible ratchet with hinge joint V6638N



**V4945-S**, EAN 4047728055352

## Fine-tooth reversible ratchet · standard

- Robust and service-friendly
- Closed system
- Easy to clean
- 72 teeth
- Opening angle: 5°
- For manual operation



10 3/8

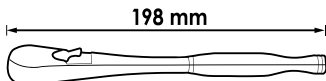

10 3/8



**V4945-REP**, EAN 4047728049481

## Repair set

- Repair set for fine-tooth reversible ratchets V4945 · V4945-S



**V6008**, EAN 4047728060080

## 360° rotary handle reversible ratchet

- Use in areas with restricted access
- Sliding square for clockwise/anti-clockwise operation
- Standard operation also possible through bolting
- Operation only clockwise
- 72 teeth
- Opening angle: 5°
- For manual operation

*Loosening and tightening of screw connections only in locked mode*

10 3/8



Actuator mechanism in the 360° rotary handle

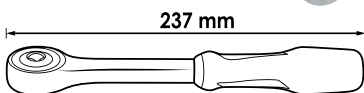

10 3/8



# Sockets



## 6-point socket



VIGOR No.	Size	L mm	EAN 4047728+
V2278N	6 mm	28	057219
V2277N	7 mm	28	056908
V2276N	8 mm	28	056892
V2275N	9 mm	28	056885
V2274N	10 mm	28	056878
V2273N	11 mm	28	056861
V2272N	12 mm	28	056854
V2271N	13 mm	28	056847
V2270N	14 mm	28	056830

VIGOR No.	Size	L mm	EAN 4047728+
V2269N	15 mm	28	057141
V2268N	16 mm	28	057134
V2267N	17 mm	30	057127
V2266N	18 mm	30	057110
V2265N	19 mm	30	057103
V2264N	20 mm	30	057097
V2263N	21 mm	30	057080
V2262N	22 mm	30	057073
V2261N	24 mm	30	057066

## 12-point socket



VIGOR No.	Size	L mm	EAN 4047728+
V7538-9	9 mm		080439
V7538-10	10 mm	28	074230
V7538-11	11 mm	28	074247
V7538-12	12 mm	28	074254
V7538-13	13 mm	28	074261
V7538-14	14 mm	28	074278
V7538-15	15 mm	28	074285
V7538-16	16 mm	28	074292
V7538-17	17 mm	30	074308
V7538-18	18 mm	30	074315
V7538-19	19 mm	30	074322

## 6-point socket · long



VIGOR No.	Size	L mm	EAN 4047728+
V2016N	8 mm	63	056922
V2017N	9 mm	63	056939
V2018N	10 mm	63	056946
V2019N	11 mm	63	056953
V2020N	12 mm	63	056960
V2311N	13 mm	63	057509
V2312N	14 mm	63	057516
V2313N	15 mm	63	057523
V2314N	17 mm	63	057530
V2315N	19 mm	63	057547

## 12-point socket · long



VIGOR No.	Size	EAN 4047728+
V7538L-9	9 mm	080644
V7538L-10	10 mm	080651
V7538L-11	11 mm	080668
V7538L-12	12 mm	080675
V7538L-13	13 mm	080682
V7538L-14	14 mm	080699
V7538L-15	15 mm	080705
V7538L-16	16 mm	080712
V7538L-17	17 mm	080729
V7538L-18	18 mm	080736
V7538L-19	19 mm	080743

## T socket

**NEW**

10 3/8"



VIGOR No.	Size	L mm	EAN 4047728+
V2724N	E4	28	084956
V2725N	E5	28	084963
V2726N	E6	28	084970
V2727N	E7	28	084987
V2728N	E8	28	084994
V2143N	E10	28	085038

VIGOR No.	Size	L mm	EAN 4047728+
V2614N	E11	28	058674
V2144N	E12	28	085045
V2145N	E14	28	085052
V2146N	E16	28	085069
V2615N	E18	28	058681
V2729N	E20	28	085076

## T socket · long

**NEW**

10 3/8"



VIGOR No.	Size	L mm	EAN 4047728+
V7014-10	E10	63	083515
V7014-11	E11	63	083522
V7014-12	E12	63	083539
V7014-14	E14	63	083546
V7014-16	E16	63	083553

## T-Plus socket

10 3/8"



VIGOR No.	Size	EAN 4047728+
V7920-EP10	E10+	078191
V7920-EP12	E12+	078207
V7920-EP14	E14+	078214
V7920-EP16	E16+	078221

## Spark plug socket

10 3/8"



VIGOR No.	Size	L mm	EAN 4047728+
V2119N	16 mm	66	057028
V2613N	18 mm	66	058667
V2120N	21 mm	66	057035



## Screwdriver socket

10 3/8"



VIGOR No.	Size	L mm	EAN 4047728+
V2288N	0.8x5.5 mm	49	057318
V2287N	1x7 mm	49	057301
V2286N	1.2x8 mm	49	057295

## Screwdriver socket

10 3/8"



VIGOR No.	Size	L mm	EAN 4047728+
V2291N	PZ1	49	057349
V2290N	PZ2	49	057332
V2289N	PZ3	49	057325

## Screwdriver socket

10 3/8"



VIGOR No.	Size	L mm	EAN 4047728+
V2294N	PH1	49	057370
V2293N	PH2	49	057363
V2292N	PH3	49	057356

## T screwdriver socket

10 3/8"



VIGOR No.	Size	L mm	EAN 4047728+
V6082	T60	49	060820
V6083	T70	49	060837



## T screwdriver socket



VIGOR No.	Size	L mm	EAN 4047728+
V2303N	T15	49	057493
V2302N	T20	49	057486
V2301N	T25	49	057479
V2300N	T27	49	057462
V2299N	T30	49	057455

VIGOR No.	Size	L mm	EAN 4047728+
V2298N	T40	49	057448
V2297N	T45	49	057431
V2149N	T47	49	085298
V2296N	T50	49	057394
V2295N	T55	49	057387

## T screwdriver socket



VIGOR No.	Size	L mm	EAN 4047728+
V6084	T20	93	060844
V6085	T25	93	060851
V6086	T27	93	060868
V6087	T30	93	060875
V6088	T40	93	060882
V6089	T45	93	060899
V6090	T50	93	060905
V6091	T55	93	060912
V6092	T60	93	060929
V6093	T70	93	060936

## T screwdriver socket



VIGOR No.	Size	L mm	EAN 4047728+
V6094	T40	133	060943
V6095	T45	133	060950
V6096	T50	133	060967
V6097	T55	133	060974
V6098	T60	133	060981
V6099	T70	133	060998

## T screwdriver socket



VIGOR No.	Size	L mm	EAN 4047728+
V6100	T40	193	061001
V6101	T45	193	061018
V6102	T50	193	061025
V6103	T55	193	061032
V6104	T60	193	061049
V6105	T70	193	061056

# Sockets



T screwdriver socket



**NEW**

10 3/8"

VIGOR No.	Size	mm	EAN 4047728+
V2193N	T40H	48	085304
V2194N	T45H	48	085564
V2195N	T50H	48	085311

Screwdriver socket for screws with internal serration (XZN)



10 3/8"

VIGOR No.	Size	mm	EAN 4047728+
V6106	M5	48	061063
V6107	M6	48	061070
V6108	M8	48	061087
V6109	M9	48	061094
V6110	M10	48	061100
V6111	M12	48	061117
V6112	M14	48	061124
V6113	M16	48	061131

Screwdriver socket for screws with internal serration (XZN)



10 3/8"

VIGOR No.	Size	mm	EAN 4047728+
V6114	M5	93	061148
V6115	M6	93	061155
V6116	M8	93	061162
V6117	M9	93	061179
V6118	M10	93	061186
V6119	M12	93	061193
V6120	M14	93	061209

Screwdriver socket for screws with internal serration (XZN)



10 3/8"

VIGOR No.	Size	mm	EAN 4047728+
V6121	M5	133	061216
V6122	M6	133	061223
V6123	M8	133	061230
V6124	M9	133	061247
V6125	M10	133	061254
V6126	M12	133	061261
V6127	M14	133	061278



## Screwdriver socket for screws with internal serration (XZN)



VIGOR No.	Size	L mm	EAN 4047728+
V6128	M8	193	061285
V6129	M10	193	061292
V6130	M12	193	061308
V6131	M14	193	061315

## Screwdriver socket for inside hexagon screws



VIGOR No.	Size	L mm	EAN 4047728+
V2285N	3 mm	49	057288
V2284N	4 mm	49	057271
V2283N	5 mm	49	057264
V2282N	6 mm	49	057257
V2281N	7 mm	49	057240
V2280N	8 mm	49	057233
V2279N	10 mm	49	057226
V6137	12 mm	49	061377
V6138	14 mm	49	061384
V6139	17 mm	49	061391
V6140	19 mm	49	061407

## Screwdriver socket for inside hexagon screws



VIGOR No.	Size	L mm	EAN 4047728+
V6141	5 mm	93	061414
V6142	6 mm	93	061421
V6143	7 mm	93	061438
V6144	8 mm	93	061445
V6145	10 mm	93	061452
V6146	11 mm	93	061469
V6147	12 mm	93	061476
V6148	13 mm	93	061483



## Screwdriver socket for inside hexagon screws

10



VIGOR No.	Size	mm	EAN 4047728+
V6149	5 mm	133	061490
V6194	6 mm	133	062466
V6151	7 mm	133	061513
V6152	8 mm	133	061520
V6153	10 mm	133	061537
V6154	12 mm	133	061544
V6155	14 mm	133	061551

## Screwdriver socket for inside hexagon screws

10



VIGOR No.	Size	mm	EAN 4047728+
V6156	5 mm	193	061568
V6157	6 mm	193	061575
V6158	7 mm	193	061582
V6159	8 mm	193	061599
V6160	10 mm	193	061605
V6161	12 mm	193	061612

## Universal joint

10 10



VIGOR No.	mm	EAN 4047728+
V2118N	50	057011

## Extension

10 10



VIGOR No.	mm	EAN 4047728+
V2115N	75	056984
V2616N	125	058698
V2117N	250	057004



## Wobble extension

- Operating screw connections in confined spaces and working in areas with restricted access
- Spherical, tapered outside square
- Angular movement to each side 8°

**10 3/8** **10 3/8**



VIGOR No.	mm	EAN 4047728+
<b>V4314</b>	36	<b>043144</b>
<b>V4315</b>	75	<b>043151</b>
<b>V4316</b>	250	<b>043168</b>

## Sliding head / adapter

**10 3/8** **12<sup>5</sup> 1/2**



VIGOR No.	mm	EAN 4047728+
<b>V2116N</b>	40	<b>056991</b>

## Bit adapter

**8 5/16** **10 3/8**



VIGOR No.	mm	EAN 4047728+
<b>V2114N</b>	28	<b>056977</b>

## Adapter

**6.3 1/4** **10 3/8**



VIGOR No.	mm	EAN 4047728+
<b>V2071</b>	27	<b>020718</b>

## Adapter

**12<sup>5</sup> 1/2** **10 3/8**



VIGOR No.	mm	EAN 4047728+
<b>V2108</b>	36	<b>021081</b>

## Bit adapter

**10 3/8** **8 5/16**



VIGOR No.	mm	EAN 4047728+
<b>V3652N</b>	30	<b>058889</b>

# Sockets



**V2460N**, EAN 4047728**056458**

## Socket set

• For manual operation

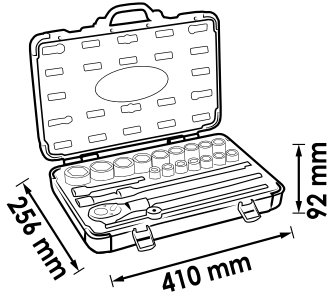
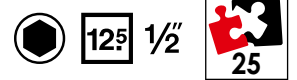

### Single parts from page 149

XX	■		Design	Size
18 x	12.5 1/2			10 · 11 · 12 · 13 · 14 · 15 · 16 · 17 · 18 · 19 · 20 · 21 · 22 · 23 · 24 · 27 · 30 · 32 mm
2 x	12.5 1/2			16 · 21 mm
1 x	-	12.5 1/2		250 mm
1 x	12.5 1/2	12.5 1/2		125 mm
1 x	12.5 1/2	12.5 1/2		250 mm
1 x	12.5 1/2	12.5 1/2		75 mm
1 x	-	12.5 1/2		250 mm



**V7512/17**, EAN 4047728**074216**

## 12-point socket set

• For manual operation

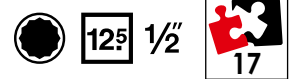

### Single parts from page 151

XX	■		Design	Size
18 x	12.5 1/2			8 · 10 · 11 · 12 · 13 · 14 · 15 · 16 · 17 · 18 · 19 · 20 · 21 · 22 · 24 · 27 · 30 · 32 mm



**V2496**, EAN 4047728**024969**

## Screwdriver socket set

• For manual operation



Single parts from page 154

XX	■		Design	Size
8 x	12.5 1/2	○		M5 · M6 · M8 · M9 · M10 · M12 · M14 · M16
9 x	12.5 1/2	○		5 · 6 · 7 · 8 · 10 · 12 · 14 · 17 · 19 mm
9 x	12.5 1/2	⊗		M5 · M6 · M7 · M8 · M9 · M10 · M12 · M13 · M14
10 x	12.5 1/2	⊗		T20 · T25 · T27 · T30 · T40 · T45 · T50 · T55 · T60 · T70



**V1917**, EAN 4047728**019170**

## T screwdriver socket set

• For manual operation

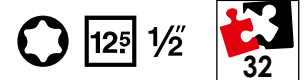

Single parts from page 155

XX	■		Design	Size
10 x	12.5 1/2	⊗		T20 · T25 · T27 · T30 · T40 · T45 · T50 · T55 · T60 · T70
10 x	12.5 1/2	⊗		T20 · T25 · T27 · T30 · T40 · T45 · T50 · T55 · T60 · T70
6 x	12.5 1/2	⊗		T40 · T45 · T50 · T55 · T60 · T70
6 x	12.5 1/2	⊗		T40 · T45 · T50 · T55 · T60 · T70





# Sockets



**V1918**, EAN 4047728**019187**

Screwdriver socket set for screws with internal serration (XZN)

• For manual operation

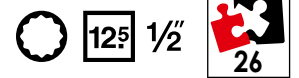

Single parts from page 154

XX	■	○	Design	Size
8 x	12.5 1/2	○		M5 · M6 · M8 · M9 · M10 · M12 · M14 · M16
7 x	12.5 1/2	○		M5 · M6 · M8 · M9 · M10 · M12 · M14
7 x	12.5 1/2	○		M5 · M6 · M8 · M10 · M12 · M14 · M9
4 x	12.5 1/2	○		M8 · M10 · M12 · M14



**V1919**, EAN 4047728**019194**

Screwdriver socket set for inside hexagon screws

• For manual operation

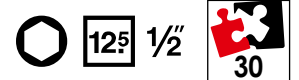

Single parts from page 153

XX	■	○	Design	Size
9 x	12.5 1/2	○		5 · 6 · 7 · 8 · 10 · 12 · 14 · 17 · 19 mm
8 x	12.5 1/2	○		5 · 6 · 7 · 8 · 10 · 11 · 12 · 13 mm
7 x	12.5 1/2	○		5 · 6 · 7 · 8 · 10 · 12 · 14 mm
6 x	12.5 1/2	○		5 · 6 · 7 · 8 · 10 · 12 mm



**V2201**, EAN 4047728022019  
**RIBE screwdriver socket set**  
 • For manual operation

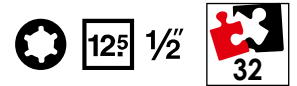

Single parts from page 156

XX	■	●	Design	Size
9 x	12.5	1/2		M5 · M6 · M7 · M8 · M9 · M10 · M12 · M13 · M14
9 x	12.5	1/2		M5 · M6 · M7 · M8 · M9 · M10 · M12 · M13 · M14
7 x	12.5	1/2		M8 · M9 · M10 · M10.3 · M12 · M13 · M14
7 x	12.5	1/2		M8 · M9 · M10 · M10.3 · M12 · M13 · M14



**V1898**, EAN 4047728018982  
**Socket set with multi-purpose profile**  
 • For manual operation

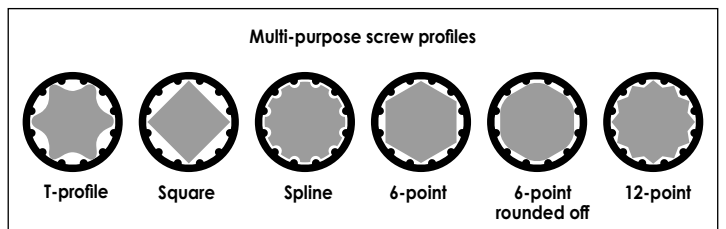
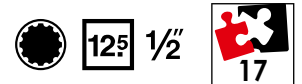

Single parts from page 153

XX	■	●	Design	Size
17 x	12.5	1/2		10 · 11 · 12 · 13 · 14 · 15 · 16 · 17 · 18 · 19 · 20 · 21 · 22 · 24 · 27 · 30 · 32 mm



All sockets suitable for 6 different profiles



**V6412/4**, EAN 4047728079518

## Stud extractor set

- Damage-free insertion and removal of studs and threaded pins
- For left and right-hand threads
- Outside hexagon drive 19 or 22 mm
- Sizes: 6 · 8 · 10 · 12 mm
- For manual operation

12<sup>5</sup> 1/2"



**V2404N**, EAN 4047728080507

## Extractor socket set with spiral profile

- Operation of nuts with damaged heads (special profile)
- For manual operation

12<sup>5</sup> 1/2"



Single parts from page 159

XX	■	●	Design	Size
13 x	12 <sup>5</sup> 1/2"	●		6 · 7 · 8 · 9 · 10 · 11 · 12 · 13 · 14 · 15 · 16 · 17 · 19 mm

**V3741N**, EAN 4047728**082518**

**Extractor socket set with spiral profile**

- Operation of nuts with damaged heads (special profile)



**NEW**



XX	■	●	Design	Size
6 x	12.5	1/2		21 · 22 · 24 · 27 · 30 · 32 mm



**V5550S**, EAN 4047728**055819**

**Impact socket set · short**

- Surface: phosphatized
- For impact operation

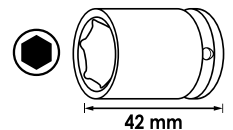
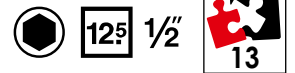

Single parts from page 159

XX	■	●	Design	Size
13 x	12.5	1/2		10 · 11 · 12 · 13 · 14 · 15 · 16 · 17 · 18 · 19 · 21 · 22 · 24 mm



# Sockets



**V5550L**, EAN 4047728**055505**

## Impact socket set · long

- Surface: phosphatized
- For impact operation

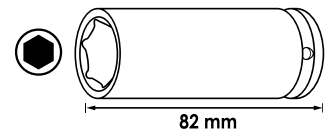
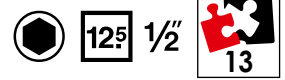

Single parts from page 159

XX	■	●	Design	Size
13 x	12.5 1/2	●		10 · 11 · 12 · 13 · 14 · 15 · 16 · 17 · 18 · 19 · 21 · 22 · 24 mm



**V7019**, EAN 4047728**066372**

## Impact screwdriver socket set for inside hexagon profile

- Surface: phosphatized
- For impact operation

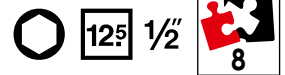

Single parts from page 160

XX	■	○	Design	Size
8 x	12.5 1/2	○		5 · 6 · 8 · 10 · 12 · 14 · 17 · 19 mm



**V7018**, EAN 4047728066846

**Impact screwdriver socket set for internal serration profile (XZN)**

- Surface: phosphatized
- For impact operation

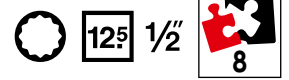

Single parts from page 160

XX	■	○	Design	Size
8 x	12.5 1/2	○		M5 · M6 · M8 · M10 · M12 · M14 · M16 · M18



**V7017**, EAN 4047728064705

**Impact screwdriver socket set for internal T profile**

- Surface: phosphatized
- For impact operation

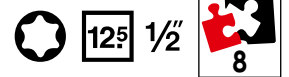

Single parts from page 159

XX	■	○	Design	Size
8 x	12.5 1/2	○		T30 · T40 · T45 · T50 · T55 · T60 · T70 · T80



# Sockets



**V6012**, EAN 4047728**055826**

## Fine-tooth reversible ratchet

- Offset design
- Plastic coating
- Quick-release press-button
- DIN 3122, ISO 3315
- 72 teeth
- Opening angle: 5°
- For manual operation

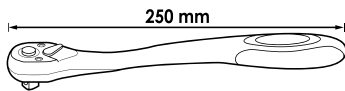
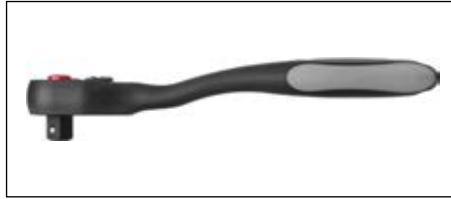

12.5 1/2

**V6012-REP**, EAN 4047728**056533**

## Repair set

- Repair set for fine-tooth reversible ratchet V6012 · V6612



**V4946-S**, EAN 4047728**055369**

## Fine-tooth reversible ratchet · standard

- Robust and service-friendly
- Closed system
- Easy to clean
- DIN 3122, ISO 3315
- 72 teeth
- Opening angle: 5°
- For manual operation



Closed system



Sturdy solid steel design

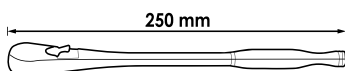

12.5 1/2

**V4946-REP**, EAN 4047728**049498**

## Repair set

- Repair set for fine-tooth reversible ratchets V4946 · V4946-S



**V4884**, EAN 4047728**048842**

## Flexible handle with reversible ratchet

- Square drive with ball locking device
- DIN 3122
- 24 teeth
- Opening angle: 15°
- For manual operation



Robust 24-teeth ratchet mechanism



180°

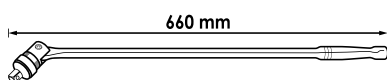

12.5 1/2

**V4884-01**, EAN 4047728**073226**

## Ratchet head



**V5437**, EAN 4047728**054379**

## 360° rotary handle reversible ratchet

- Use in areas with restricted access
- Sliding square for clockwise/anti-clockwise operation
- Standard operation also possible through bolting
- Operation only clockwise
- 72 teeth
- Opening angle: 5°
- For manual operation



12<sup>5</sup> 1/2"

Loosening and tightening of screw connections only in locked mode

Actuator mechanism in the handle

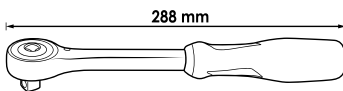

12<sup>5</sup> 1/2"



**V6612N**, EAN 4047728**080330**

## Telescopic reversible ratchet with hinge joint

- Telescopic range 350 – 490 mm
- 180° swivel head with locking mechanism
- Quick-release press-button
- 90 teeth
- Opening angle: 4°
- For manual operation



Latches in 5 positions

12<sup>5</sup> 1/2"

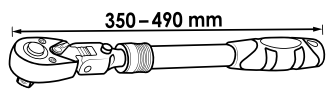

**V6612N-REP**, EAN 4047728**081733**

## Repair set

- Repair set for telescopic reversible ratchet with hinge joint V6612N



## Sliding T-handle

12<sup>5</sup> 1/2"



VIGOR No.	L mm	EAN 4047728+
V2573N	250	058391

## Sliding piece

12<sup>5</sup> 1/2"



VIGOR No.	L mm	EAN 4047728+
V2667N	43.7	058728



# Sockets



## 6-point socket



VIGOR No.	Size	mm	EAN 4047728+
V4709N	8 mm	38	058902
V2465N	10 mm	38	058186
V2598N	11 mm	38	058629
V2603N	12 mm	38	058650
V2599N	13 mm	38	058636
V2600N	14 mm	38	058643
V2561N	15 mm	38	058261
V2562N	16 mm	38	058278
V2563N	17 mm	38	058285
V2564N	18 mm	38	058292

VIGOR No.	Size	mm	EAN 4047728+
V2565N	19 mm	38	058308
V2566N	20 mm	38	058315
V2567N	21 mm	38	058322
V2568N	22 mm	38	058339
V2569N	23 mm	38	058346
V2570N	24 mm	38	058353
V2571N	27 mm	42	058360
V2572N	30 mm	44	058377
V2574N	32 mm	44	058384

## 12-point socket



VIGOR No.	Size	mm	EAN 4047728+
V7512-8	8 mm	38	074339
V7512-9	9 mm	38	080446
V7512-10	10 mm	38	074346
V7512-11	11 mm	38	074353
V7512-12	12 mm	38	074360
V7512-13	13 mm	38	074377
V7512-14	14 mm	38	074384
V7512-15	15 mm	38	074391
V7512-16	16 mm	38	074407
V7512-17	17 mm	38	074414
V7512-18	18 mm	38	074421

VIGOR No.	Size	mm	EAN 4047728+
V7512-19	19 mm	38	074438
V7512-20	20 mm	38	074445
V7512-21	21 mm	38	074452
V7512-22	22 mm	38	074469
V7512-23	23 mm	38	074476
V7512-24	24 mm	38	074483
V7512-27	27 mm	42	074490
V7512-30	30 mm	44	074506
V7512-32	32 mm	44	074513
V7512-36	36 mm	46	080477

## 6-point socket · long



VIGOR No.	Size	mm	EAN 4047728+
V2579N	10 mm	77	058445
V2580N	11 mm	77	058452
V2581N	12 mm	77	058469
V2584N	13 mm	77	058483
V2585N	14 mm	77	058490
V2586N	15 mm	77	058506
V2587N	16 mm	77	058513
V2588N	17 mm	77	058520
V2589N	18 mm	77	058537
V2590N	19 mm	77	058544
V2591N	22 mm	77	058551

## 12-point socket · long



VIGOR No.	Size	EAN 4047728+
V7512L-10	10 mm	080750
V7512L-11	11 mm	080767
V7512L-12	12 mm	080774
V7512L-13	13 mm	080781
V7512L-14	14 mm	080798
V7512L-15	15 mm	080804
V7512L-16	16 mm	080811
V7512L-17	17 mm	080828
V7512L-18	18 mm	080835
V7512L-19	19 mm	080842
V7512L-22	22 mm	080859

## T socket

**NEW**

12<sup>5</sup> 1/2"



VIGOR No.	Size	L mm	EAN 4047728+
V2730N	E10	38	085083
V2731N	E11	38	085090
V2732N	E12	38	085106
V2733N	E14	38	085113
V2734N	E16	38	085120
V2196N	E18	38	085137
V2197N	E20	38	085144
V2735N	E22	38	085151
V2592N	E24	38	058568

## T socket · long

**NEW**

12<sup>5</sup> 1/2"



VIGOR No.	Size	L mm	EAN 4047728+
V7014-18	E18	77	083560
V7014-20	E20	77	083577
V7014-22	E22	77	083584
V7014-24	E24	77	083591

## T-Plus socket

12<sup>5</sup> 1/2"



VIGOR No.	Size	EAN 4047728+
V7920-EP18	E18+	078238
V7920-EP20	E20+	078245
V7920-EP22	E22+	078252
V7920-EP24	E24+	078269

## Spark plug socket

12<sup>5</sup> 1/2"



VIGOR No.	Size	L mm	EAN 4047728+
V2578N	16 mm	66	058438
V2582N	21 mm	66	058476

# Sockets



## Socket with multi-purpose profile



VIGOR No.	Size	L mm	EAN 4047728+
V1988	10 mm	38.1	019880
V1989	11 mm	38.1	019897
V1990	12 mm	38.1	019903
V1991	13 mm	38.1	019910
V1992	14 mm	38.1	019927
V1993	15 mm	38.1	019934
V1994	16 mm	38.1	019941
V1995	17 mm	38.1	019958
V1996	18 mm	38.1	019965

VIGOR No.	Size	L mm	EAN 4047728+
V1997	19 mm	38.1	019972
V1998	20 mm	38.1	019989
V1999	21 mm	38.1	019996
V2000	22 mm	38.1	020008
V2001	24 mm	40	020015
V2002	27 mm	42	020022
V2003	30 mm	45	020039
V2004	32 mm	45	020046

## Screwdriver socket for inside hexagon screws



VIGOR No.	Size	L mm	EAN 4047728+
V2101	5 mm	55	021012
V2102	6 mm	55	021029
V2103	7 mm	55	021036
V2104	8 mm	55	021043
V2105	10 mm	55	021050

VIGOR No.	Size	L mm	EAN 4047728+
V2106	12 mm	55	021067
V2107	14 mm	55	021074
V2069	17 mm	55	020695
V2070	19 mm	55	020701

## Screwdriver socket for inside hexagon screws



VIGOR No.	Size	L mm	EAN 4047728+
V2072	5 mm	100	020725
V2073	6 mm	100	020732
V2074	7 mm	100	020749
V2075	8 mm	100	020756

VIGOR No.	Size	L mm	EAN 4047728+
V2076	10 mm	100	020763
V2077	11 mm	100	020770
V2078	12 mm	100	020787
V2079	13 mm	100	020794

## Screwdriver socket for inside hexagon screws



VIGOR No.	Size	L mm	EAN 4047728+
V2080	5 mm	140	020800
V2081	6 mm	140	020817
V2082	7 mm	140	020824
V2083	8 mm	140	020831
V2084	10 mm	140	020848
V2085	12 mm	140	020855
V2086	14 mm	140	020862

## Screwdriver socket for inside hexagon screws



VIGOR No.	Size	L mm	EAN 4047728+
V2087	5 mm	200	020879
V2088	6 mm	200	020886
V2089	7 mm	200	020893
V2090	8 mm	200	020909
V2091	10 mm	200	020916
V2092	12 mm	200	020923

## Screwdriver socket for screws with internal serration (XZN)



VIGOR No.	Size	L mm	EAN 4047728+
V2094	M5	55	020947
V2095	M6	55	020954
V2096	M8	55	020961
V2097	M9	55	020978

VIGOR No.	Size	L mm	EAN 4047728+
V2098	M10	55	020985
V2099	M12	55	020992
V2065	M14	55	020657
V2100	M16	55	021005

## Screwdriver socket for screws with internal serration (XZN)



VIGOR No.	Size	L mm	EAN 4047728+
V2066	M5	100	020664
V2068	M6	100	020688
V2067	M8	100	020671
V2113	M9	100	021135
V2059	M10	100	020596
V2060	M12	100	020602
V2121	M14	100	021210

## Screwdriver socket for screws with internal serration (XZN)



VIGOR No.	Size	L mm	EAN 4047728+
V2122	M5	140	021227
V2124	M6	140	021241
V2123	M8	140	021234
V2126	M9	140	021265
V2128	M10	140	021289
V2129	M12	140	021296
V2132	M14	140	021326

## Screwdriver socket for screws with internal serration (XZN)



VIGOR No.	Size	L mm	EAN 4047728+
V2133	M8	200	021333
V2134	M10	200	021340
V2135	M12	200	021357
V2137	M14	200	021371

## T screwdriver socket



VIGOR No.	Size	Length mm	EAN 4047728+
V2151	T20	55	021517
V2152	T25	55	021524
V2153	T27	55	021531
V2154	T30	55	021548
V2155	T40	55	021555

VIGOR No.	Size	Length mm	EAN 4047728+
V2156	T45	55	021562
V2157	T50	55	021579
V2198N	T55	55	085328
V2199N	T60	55	085335
V2160	T70	55	021609

## T screwdriver socket



VIGOR No.	Size	Length mm	EAN 4047728+
V2161	T20	100	021616
V2162	T25	100	021623
V2163	T27	100	021630
V2165	T30	100	021654
V2167	T40	100	021678

VIGOR No.	Size	Length mm	EAN 4047728+
V2168	T45	100	021685
V2169	T50	100	021692
V2170	T55	100	021708
V2171	T60	100	021715
V2172	T70	100	021722

## T screwdriver socket



VIGOR No.	Size	Length mm	EAN 4047728+
V2173	T40	140	021739
V2174	T45	140	021746
V2175	T50	140	021753
V2176	T55	140	021760
V2177	T60	140	021777
V2178	T70	140	021784

## T screwdriver socket



VIGOR No.	Size	Length mm	EAN 4047728+
V2179	T40	200	021791
V2180	T45	200	021807
V2181	T50	200	021814
V2182	T55	200	021821
V2183	T60	200	021838
V2184	T70	200	021845

## T-Plus screwdriver socket



VIGOR No.	Size	EAN 4047728+
V7055-IP40	T40+	078344
V7055-IP45	T45+	078351
V7055-IP50	T50+	078368
V7055-IP55	T55+	078375
V7055-IP60	T60+	078382

## T-Plus screwdriver socket



VIGOR No.	Size	EAN 4047728+
V7055-IPR40	T40+H	078467
V7055-IPR45	T45+H	078474
V7055-IPR50	T50+H	078481
V7055-IPR55	T55+H	078498
V7055-IPR60	T60+H	078504

## T screwdriver socket



VIGOR No.	Size	L mm	EAN 4047728+
V7055-T40H	T40H	55	078511
V7055-T45H	T45H	55	078528
V7055-T50H	T50H	55	078535
V7055-T55H	T55H	55	078542
V7055-T60H	T60H	55	078559

## RIBE screwdriver socket



VIGOR No.	Size	L mm	EAN 4047728+
V2202	M5	55	022026
V2203	M6	55	022033
V2204	M7	55	022040
V2205	M8	55	022057
V2206	M9	55	022064

VIGOR No.	Size	L mm	EAN 4047728+
V2207	M10	55	022071
V2208	M12	55	022088
V2209	M13	55	022095
V2210	M14	55	022101

## RIBE screwdriver socket



VIGOR No.	Size	L mm	EAN 4047728+
V2211	M5	100	022118
V2212	M6	100	022125
V2213	M7	100	022132
V2214	M8	100	022149
V2215	M9	100	022156

VIGOR No.	Size	L mm	EAN 4047728+
V2216	M10	100	022163
V2217	M12	100	022170
V2218	M13	100	022187
V2219	M14	100	022194

## RIBE screwdriver socket



VIGOR No.	Size	L mm	EAN 4047728+
V2220	M8	140	022200
V2221	M9	140	022217
V2222	M10	140	022224
V2223	M10.3	140	022231
V2224	M12	140	022248
V2225	M13	140	022255
V2226	M14	140	022262

# Sockets



## RIBE screwdriver socket



VIGOR No.	Size	mm	EAN 4047728+
V2227	M8	200	022279
V2228	M9	200	022286
V2229	M10	200	022293
V2230	M10.3	200	022309
V2231	M12	200	022316
V2232	M13	200	022323
V2233	M14	200	022330

## Universal joint

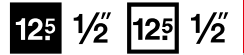

VIGOR No.	mm	EAN 4047728+
V2575N	75	058407

## Extension

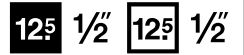

VIGOR No.	mm	EAN 4047728+
V2576N	125	058414
V2577N	250	058421
V4398N	750	058896

## Wobble extension

- Operating screw connections in confined spaces and working in areas with restricted access
- Spherical, tapered outside square

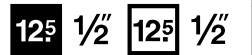

VIGOR No.	mm	EAN 4047728+
V4317	50	043175
V4318	75	043182
V4319	250	043199



## Adapter

**10** 3/8" **12<sup>5</sup>** 1/2"



VIGOR No.	mm	EAN 4047728+
<b>V2109</b>	36	<b>021098</b>

## Adapter

**20** 3/4" **12<sup>5</sup>** 1/2"



VIGOR No.	mm	EAN 4047728+
<b>V2110</b>	46	<b>021104</b>

## Bit adapter

**8** 5/16" **12<sup>5</sup>** 1/2"



VIGOR No.	mm	EAN 4047728+
<b>V2647N</b>	37	<b>058711</b>

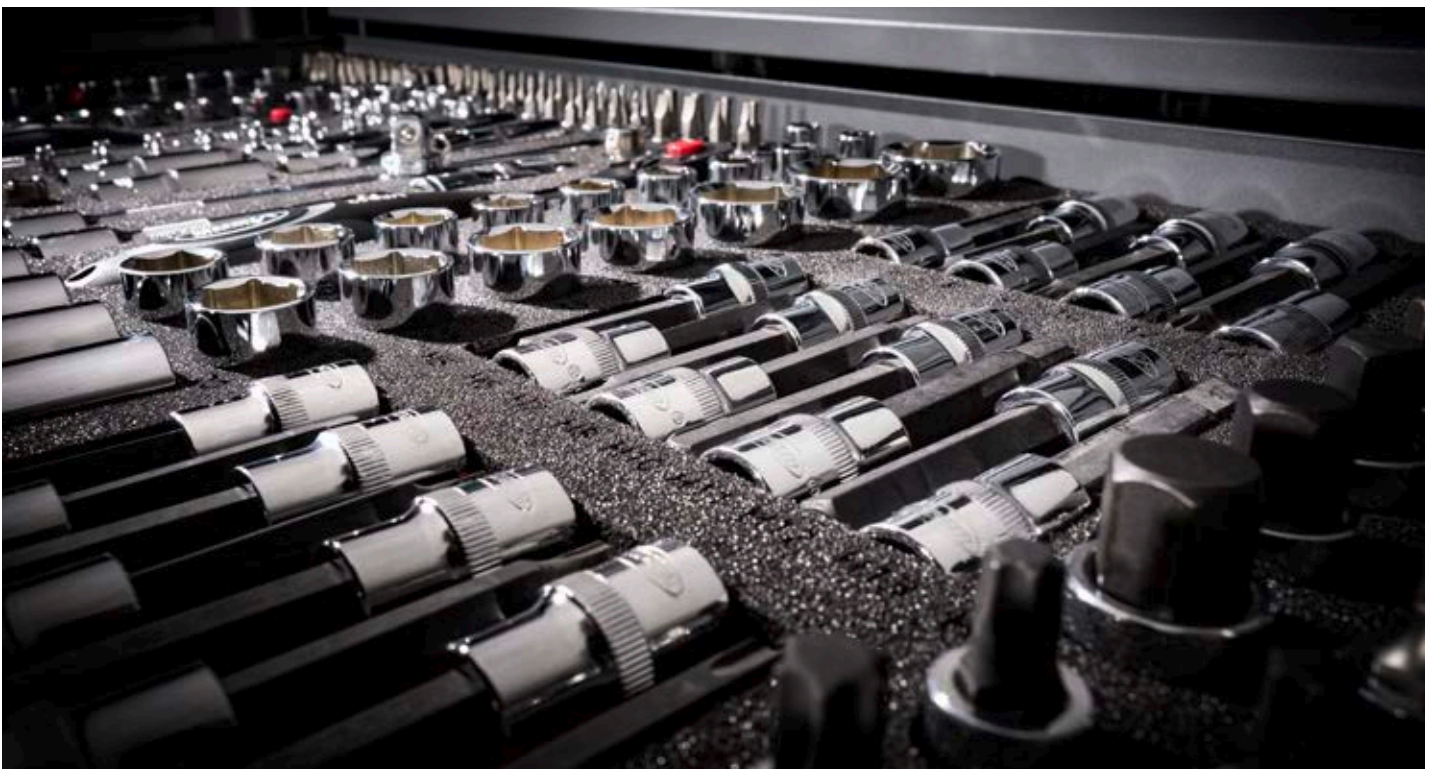



## Impact wrench socket · short

- Surface: phosphatized
- For impact operation

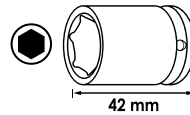

VIGOR No.	Size	EAN 4047728+
V5550S-10	10 mm	056175
V5550S-11	11 mm	056182
V5550S-12	12 mm	056199
V5550S-13	13 mm	056205
V5550S-14	14 mm	056212
V5550S-15	15 mm	056229
V5550S-16	16 mm	056236
V5550S-17	17 mm	056243
V5550S-18	18 mm	056250
V5550S-19	19 mm	056267
V5550S-21	21 mm	056274
V5550S-22	22 mm	056281
V5550S-24	24 mm	056298

## Impact wrench socket · long

- Surface: phosphatized
- For impact operation

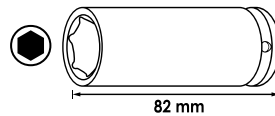

VIGOR No.	Size	EAN 4047728+
V5550L-10	10 mm	056045
V5550L-11	11 mm	056052
V5550L-12	12 mm	056069
V5550L-13	13 mm	056076
V5550L-14	14 mm	056083
V5550L-15	15 mm	056090
V5550L-16	16 mm	056106
V5550L-17	17 mm	056113
V5550L-18	18 mm	056120
V5550L-19	19 mm	056137
V5550L-21	21 mm	056144
V5550L-22	22 mm	056151
V5550L-24	24 mm	056168

## Extractor socket with spiral profile

- Operation of nuts with damaged heads (special profile)
- For manual operation



VIGOR No.	Size	L mm	EAN 4047728+
V2404N-6	6 mm	50	082327
V2404N-7	7 mm	50	082334
V2404N-8	8 mm	50	082341
V2404N-9	9 mm	50	082358
V2404N-10	10 mm	50	082365
V2404N-11	11 mm	50	082372
V2404N-12	12 mm	50	082389
V2404N-13	13 mm	50	082396
V2404N-14	14 mm	50	082402
V2404N-15	15 mm	50	082419

VIGOR No.	Size	L mm	EAN 4047728+
V2404N-16	16 mm	50	082426
V2404N-17	17 mm	50	082433
V2404N-19	19 mm	50	082440
V2404N-21	21 mm	50	082457
V2404N-22	22 mm	50	082464
V2404N-24	24 mm	50	082471
V2404N-27	27 mm	50	082488
V2404N-30	30 mm	50	082495
V2404N-32	32 mm	50	082501

## Impact screwdriver socket

- Surface: phosphatized
- For impact operation



VIGOR No.	Size	L mm	EAN 4047728+
V7017-T30	T30	78	066389
V7017-T40	T40	78	066396
V7017-T45	T45	78	066402
V7017-T50	T50	78	066419
V7017-T55	T55	78	066426
V7017-T60	T60	78	066242
V7017-T70	T70	78	066259
V7017-T80	T80	78	066266

## Impact screwdriver socket

- Surface: phosphatized
- For impact operation



VIGOR No.	Size	L mm	EAN 4047728+
V7018-M5	M5	78	066273
V7018-M6	M6	78	066280
V7018-M8	M8	78	066297
V7018-M10	M10	78	066303
V7018-M12	M12	78	066518
V7018-M14	M14	78	066525
V7018-M16	M16	78	066532
V7018-M18	M18	78	066549

## Impact screwdriver socket

- Surface: phosphatized
- For impact operation



VIGOR No.	Size	L mm	EAN 4047728+
V7019-H5	5 mm	78	066556
V7019-H6	6 mm	78	066563
V7019-H8	8 mm	78	066570
V7019-H10	10 mm	78	066587
V7019-H12	12 mm	78	066594
V7019-H14	14 mm	78	066600
V7019-H17	17 mm	78	066617
V7019-H19	19 mm	78	066624

## Impact socket (12-point) · short

- Extra thin-walled socket for cardan shaft screw connections in the wheel hub
- Borehole for locking pin or safety spring and groove for o-ring
- Adjusted to given spaces in the wheel hub
- For e.g.:
  - VW Touareg model year 2003 →
  - AUDI A4 model year 2001 → · A6 model year 2005 → · A8 model year 2003 → · Q7 model year 2007 →
  - Other models
- For impact operation

● 32 mm

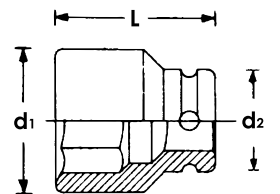

VIGOR No.	d1 mm	d2 mm	Size	L mm	EAN 4047728+
V4477	44.4	30	32 mm	50	044776

## Impact socket (12-point) · short

- Extra thin-walled socket for cardan shaft screw connections in the wheel hub
- Borehole for locking pin or safety spring and groove for o-ring
- Adjusted to given spaces in the wheel hub
- For e.g.:
  - OPEL Corsa D model year 2006 →, Adam model year 2012 →, Mokka model year 2012 →
  - CHEVROLET/GMC Trax model year 2013 →
  - Other models
- Also for BMW · SEAT and VW vehicles
- For impact operation

● 36 mm

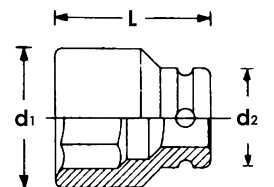

VIGOR No.	d1 mm	d2 mm	Size	L mm	EAN 4047728+
V4478	46.9	30	36 mm	50	044783

**V2318N**, EAN 4047728**059299**

## Socket set

- 24 teeth
- Opening angle: 15°
- For manual operation

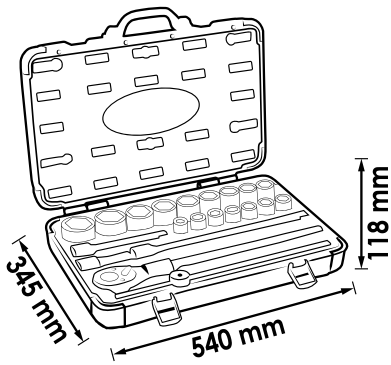
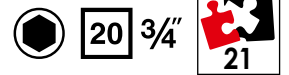

### Single parts from page 161

XX	■	●	Design	Size
16 x	20 3/4	●		19 · 21 · 22 · 23 · 24 · 26 · 27 · 28 · 30 · 32 · 34 · 36 · 38 · 41 · 46 · 50 mm
1 x	-	20 3/4		500 mm
1 x	20 3/4	20 3/4		100 mm
1 x	20 3/4	20 3/4		200 mm
1 x	20 3/4	20 3/4		400 mm
1 x	-	20 3/4		450 mm



## Reversible ratchet

- 24 teeth
- Opening angle: 15°
- For manual operation

20 3/4



VIGOR No.	mm	EAN 4047728+
V2319N	500	059282

## Sliding T-handle

- For manual operation

20 3/4



VIGOR No.	mm	EAN 4047728+
V2322N	450	057158

## Adapter

12<sup>5</sup> 1/2 20 3/4



VIGOR No.	mm	EAN 4047728+
V2111	50	021111

## Extension

20 3/4" 20 3/4"



VIGOR No.	mm	EAN 4047728+
V2320N	100	057561
V2321N	200	057578
V2317N	400	057554

## 6-point socket

20 3/4"



VIGOR No.	Size	mm	EAN 4047728+
V2323N	19 mm	50	057165
V2324N	21 mm	50	057172
V2325N	22 mm	50	057189
V2326N	23 mm	50	057196
V2327N	24 mm	50	057202
V2328N	26 mm	50	057615
V2329N	27 mm	52	057622
V2256N	28 mm	52	057059
V2924N	30 mm	54	057639
V2331N	32 mm	56	057646
V2332N	34 mm	58	057653
V2333N	36 mm	58	057677
V2334N	38 mm	60	057684
V2337N	41 mm	64	057721
V2336N	46 mm	68	057707
V2335N	50 mm	68	057691

## V5024, EAN 4047728050241

### Impact socket set

- Extra thin-walled sockets for drive shaft screw joints in the wheel hub
- Adjusted to given spaces in the wheel hub
- Among others for:
  - Size 24: VW Touran model year 2006 →
  - Size 30: VW Passat C, Golf 4, Polo, New Beetle · AUDI TT · ŠKODA Octavia, Superb, Fabia
  - Size 32: VW Touareg model year 2003 →
  - Size 36: BMW 3-series · 5-series · 7-series · SEAT Ibiza · VW Polo, Golf Plus · OPEL Corsa D · Adam · Mokka · CHEVROLET Trax model year → 2013 · FIAT 500 · Grande Punto · Punto Evo model year → 2005 · FORD Ka · MERCEDES-BENZ S-Class · JAGUAR XJ40 · XJ181
- For impact operation

20 3/4" 4



VIGOR No.	d1 mm	d2 mm	Size	mm	EAN 4047728+
V5025	44.3	35	24 mm	44	050258
V5026	44.3	42	30 mm	50	050265
V5182	44.3	44.3	32 mm	50	051828
V5183	44.3	46.9	36 mm	50	051835

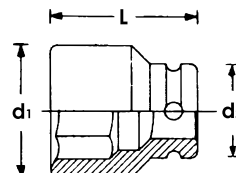

## V7212, EAN 4047728072120

### Impact screwdriver socket set

- Common screw connections VAG vehicles, e.g. brake carriers, central drive shafts, shock absorbers or screwed wheel bearing units
- Surface: burnished, oiled
- For impact operation

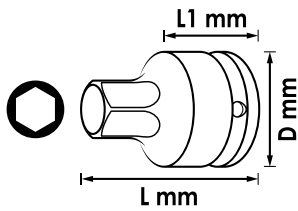
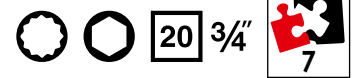

VIGOR No.	d2 mm	Size	L1 mm	L mm	EAN 4047728+
V7212-H14	44	14 mm	30	60	072168
V7212-H17	44	17 mm	30	60	072175
V7212-H19	44	19 mm	30	60	072182
V7212-H21	44	21 mm	30	60	072199
V7212-M14	44	M14	30	60	072137
V7212-M16	44	M16	30	60	072144
V7212-M18	44	M18	30	60	072151



## V5505N, EAN 4047728080484

### Impact universal joint set

- Working in areas with restricted access, and for getting around obstructive edges
- For impact operation

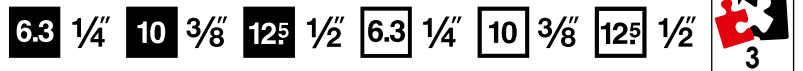

VIGOR No.	EAN 4047728+
V5505N-1/4	083324
V5505N-3/8	083317
V5505N-1/2	083300



**V1293**, EAN 4047728**012935**

**Adapter set**

• For manual operation

6.3	1/4"	10	3/8"	12.5	1/2"	20	3/4"	
6.3	1/4"	10	3/8"	12.5	1/2"	20	3/4"	



Single parts from page 129

XX	■		Design	Size
1 x	6.3 1/4"	10 3/8"		26 mm
1 x	10 3/8"	6.3 1/4"		27 mm
1 x	10 3/8"	12.5 1/2"		36 mm
1 x	12.5 1/2"	10 3/8"		36 mm
1 x	12.5 1/2"	20 3/4"		46 mm
1 x	20 3/4"	12.5 1/2"		50 mm



**V1781N**, EAN 4047728**085182**

**T socket set**

6.3	1/4"	10	3/8"	12.5	1/2"	
6.3	1/4"	10	3/8"	12.5	1/2"	

**NEW**



Single parts from page 125

XX	■		Design	Size
5 x	6.3 1/4"			E4 · E5 · E6 · E7 · E8
7 x	6.3 1/4"			T8 · T10 · T15 · T20 · T25 · T27 · T30
6 x	6.3 1/4"			T9H · T10H · T15H · T20H · T25H · T30H
4 x	10 3/8"			E10 · E12 · E14 · E16
4 x	10 3/8"			T40 · T45 · T47 · T50
3 x	10 3/8"			T40H · T45H · T50H
2 x	12.5 1/2"			E18 · E20
2 x	12.5 1/2"			T55 · T60
1 x	12.5 1/2"			T55H



# Sockets



**V2687N**, EAN 4047728**084376**







T socket set

6.3 1/4" 10 3/8" 12.5 1/2"  28

**NEW**



Single parts from page 125



	■		Design	Size
7 x	6.3 1/4"			E4 · E5 · E6 · E7 · E8 · E10 · E11
12 x	10 3/8"			E4 · E5 · E6 · E7 · E8 · E10 · E11 · E12 · E14 · E16 · E18 · E20
9 x	12.5 1/2"			E10 · E11 · E12 · E14 · E16 · E18 · E20 · E22 · E24



**V7014**, EAN 4047728**083447**

T socket set







• Longer T sockets – greater flexibility and reach when working in hard-to-reach places

 6.3 1/4" 10 3/8" 12.5 1/2"  14

**NEW**



Single parts from page 125

	■		Design	Size
5 x	6.3 1/4"			E4 · E5 · E6 · E7 · E8
5 x	10 3/8"			E10 · E11 · E12 · E14 · E16
4 x	12.5 1/2"			E18 · E20 · E22 · E24



**V2461N**, EAN 4047728056472

## Socket set

• For manual operation

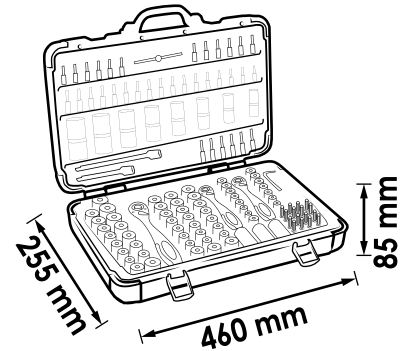
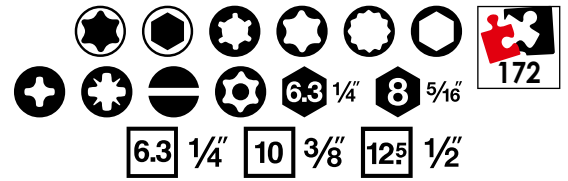

### Single parts from page 124

XX	■	Design	Size
5 x	6.3 1/4	R5 · R6 · R7 · R8 · R9	
3 x	6.3 1/4	T5 · T6 · T7	
3 x	6.3 1/4	M5 · M6 · M8	
9 x	6.3 1/4	T7H · T10H · T15H · T20H · T25H · T27H · T30H · T40H · T45H	
6 x	8 5/16	T40 · T45 · T50 · T55 · T60 · T70	
5 x	8 5/16	7 · 8 · 10 · 12 · 14 mm	
2 x	8 5/16	PH3 · PH4	
2 x	8 5/16	PZ3 · PZ4	
3 x	8 5/16	1.6x8 · 1.6x10 · 2x12 mm	
6 x	8 5/16	T40H · T45H · T50H · T55H · T60H · T70H	
1 x	6.3 1/4	25 mm	
1 x	10 3/8	28 mm	
1 x	12 1/2	37 mm	
1 x	-	150 mm	
1 x	6.3 1/4	110 mm	
1 x	-	43.7 mm	
4 x	6.3 1/4	3 · 4 · 5 · 6 mm	
4 x	6.3 1/4	0.8x4 · 1x5.5 · 1.2x6.5 · 1.2x7 mm	
3 x	6.3 1/4	PH0 · PH1 · PH2	
3 x	6.3 1/4	PZ0 · PZ1 · PZ2	
8 x	6.3 1/4	T8 · T9 · T10 · T15 · T20 · T25 · T27 · T30	
7 x	6.3 1/4	T8H · T9H · T10H · T15H · T25H · T27H · T30H	
6 x	10 3/8	E10 · E11 · E12 · E14 · E16 · E18	

XX	■	Design	Size
6 x	10 3/8	10 · 11 · 12 · 13 · 14 · 15 mm	
10 x	10 3/8	10 · 11 · 12 · 13 · 14 · 15 · 16 · 17 · 18 · 19 mm	
17 x	12 1/2	10 · 11 · 12 · 13 · 14 · 15 · 16 · 17 · 18 · 19 · 20 · 21 · 22 · 24 · 27 · 30 · 32 mm	
5 x	12 1/2	16 · 17 · 18 · 19 · 22 mm	
2 x	12 1/2	E20 · E22	
13 x	6.3 1/4	4 · 4.5 · 5 · 5.5 · 6 · 7 · 8 · 9 · 10 · 11 · 12 · 13 · 14 mm	
7 x	6.3 1/4	4 · 5 · 6 · 7 · 8 · 9 · 10 mm	
5 x	6.3 1/4	E4 · E5 · E6 · E7 · E8	
1 x	-	150 mm	
1 x	-	198 mm	
1 x	-	250 mm	
1 x	6.3 1/4	40 mm	
1 x	10 3/8	50 mm	
1 x	12 1/2	75 mm	
1 x	6.3 1/4	50 mm	
1 x	6.3 1/4	100 mm	
1 x	10 3/8	125 mm	
1 x	12 1/2	125 mm	
1 x	12 1/2	250 mm	
1 x	10 3/8	18 mm	
2 x	12 1/2	16 · 21 mm	



# Sockets



**V3277N**, EAN 4047728**056489**

Socket set

• For manual operation

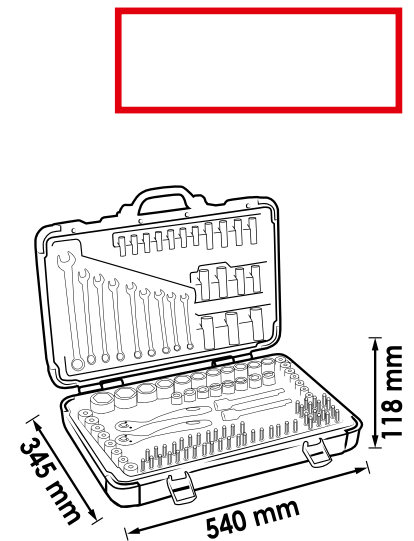

Single parts from page 124

XX	■	●	Design	Size
3 x	6.3 1/4	+		PH1 · PH2 · PH3
3 x	6.3 1/4	+		PZ1 · PZ2 · PZ3
3 x	6.3 1/4	—		1 x 5.5 · 1 x 6 · 1.6 x 8 mm
5 x	6.3 1/4	○		3 · 4 · 5 · 6 · 7 mm
6 x	6.3 1/4	+		T15H · T20H · T25H · T27H · T30H · T40H
10 x	6.3 1/4	+		T10 · T15 · T20 · T25 · T27 · T30 · T40 · T45 · T8 · T9
4 x	8 5/16	○		7 · 8 · 10 · 12 mm
3 x	8 5/16	—		1.6 x 8 · 1.6 x 10 · 2 x 12 mm
3 x	8 5/16	+		PH2 · PH3 · PH4
3 x	8 5/16	+		PZ2 · PZ3 · PZ4
5 x	8 5/16	+		T40 · T45 · T50 · T55 · T60
5 x	8 5/16	+		T40H · T45H · T50H · T55H · T60H
4 x	8 5/16	+		R10 · R11 · R12 · R13
2 x	8 5/16	○		M10 · M12
1 x	-	6.3 1/4		200 mm
2 x	-	○		1.3 · 2 mm
12 x	-	●		8 · 9 · 10 · 11 · 12 · 13 · 14 · 15 · 17 · 19 · 22 · 24 mm
1 x	10 3/8	8 5/16		28 mm
1 x	12.5 1/2	8 5/16		37 mm
1 x	6.3 1/4	6.3 1/4		25 mm
1 x	-	6.3 1/4		150 mm
10 x	10 3/8	●		11 · 10 · 12 · 13 · 14 · 15 · 16 · 17 · 18 · 19 mm

XX	■	●	Design	Size
6 x	10 3/8	●		E18 · E16 · E14 · E12 · E11 · E10
6 x	10 3/8	●		10 · 11 · 12 · 13 · 14 · 15 mm
14 x	12.5 1/2	●		13 · 14 · 15 · 16 · 17 · 18 · 19 · 20 · 21 · 22 · 24 · 27 · 30 · 32 mm
3 x	12.5 1/2	●		E24 · E22 · E20
5 x	12.5 1/2	●		16 · 17 · 18 · 19 · 22 mm
13 x	6.3 1/4	●		4 · 4.5 · 5 · 5.5 · 6 · 7 · 8 · 9 · 10 · 11 · 12 · 13 · 14 mm
5 x	6.3 1/4	●		E8 · E7 · E6 · E5 · E4
7 x	6.3 1/4	●		4 · 5 · 6 · 7 · 8 · 9 · 10 mm
1 x	-	6.3 1/4		150 mm
1 x	-	10 3/8		198 mm
1 x	-	12.5 1/2		250 mm
1 x	12.5 1/2	12.5 1/2		75 mm
1 x	10 3/8	10 3/8		50 mm
1 x	6.3 1/4	6.3 1/4		40 mm
1 x	12.5 1/2	12.5 1/2		125 mm
1 x	10 3/8	10 3/8		125 mm
1 x	6.3 1/4	6.3 1/4		100 mm
1 x	6.3 1/4	6.3 1/4		50 mm
1 x	12.5 1/2	12.5 1/2		250 mm
2 x	12.5 1/2	●		21 · 16 mm
1 x	10 3/8	●		18 mm

V5461, EAN 4047728080323

## Socket set

• For manual operation

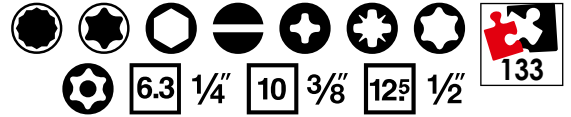

12-point design



Single parts from page 125

XX	■	●	Design	Size
13 x	6.3 1/4	●		4 · 4.5 · 5 · 5.5 · 6 · 7 · 8 · 9 · 10 · 11 · 12 · 13 · 14 mm
11 x	10 3/8	●		9 · 10 · 11 · 12 · 13 · 14 · 15 · 16 · 17 · 18 · 19 mm
20 x	12.5 1/2	●		9 · 10 · 11 · 12 · 13 · 14 · 15 · 16 · 17 · 18 · 19 · 20 · 21 · 22 · 23 · 24 · 27 · 30 · 32 · 36 mm
11 x	6.3 1/4	●		4 · 5 · 5.5 · 6 · 7 · 8 · 9 · 10 · 11 · 12 · 13 mm
11 x	10 3/8	●		9 · 10 · 11 · 12 · 13 · 14 · 15 · 16 · 17 · 18 · 19 mm
11 x	12.5 1/2	●		10 · 11 · 12 · 13 · 14 · 15 · 16 · 17 · 18 · 19 · 22 mm
5 x	6.3 1/4	●		E4 · E5 · E6 · E7 · E8
6 x	10 3/8	●		E10 · E11 · E12 · E14 · E16 · E18
3 x	12.5 1/2	●		E20 · E22 · E24
4 x	6.3 1/4	○		3 · 4 · 5 · 6 mm
4 x	6.3 1/4	●		0.8x4 · 1x5.5 · 1.2x6.5 · 1.2x7 mm
3 x	6.3 1/4	●		PH0 · PH1 · PH2

XX	■	●	Design	Size
3 x	6.3 1/4	●		PZ0 · PZ1 · PZ2
8 x	6.3 1/4	●		T8 · T9 · T10 · T15 · T20 · T25 · T27 · T30
8 x	6.3 1/4	●		T8H · T9H · T10H · T15H · T20H · T25H · T27H · T30H
1 x	6.3 1/4	6.3 1/4		40 mm
1 x	10 3/8	10 3/8		50 mm
1 x	12.5 1/2	12.5 1/2		75 mm
1 x	-	6.3 1/4		150 mm
1 x	6.3 1/4	6.3 1/4		110 mm
1 x	-	12.5 1/2		43.7 mm
1 x	6.3 1/4	6.3 1/4		50 mm
1 x	6.3 1/4	6.3 1/4		100 mm
1 x	10 3/8	10 3/8		125 mm
1 x	12.5 1/2	12.5 1/2		125 mm
1 x	12.5 1/2	12.5 1/2		250 mm

# Universal tool cases



V4425N, EAN 4047728058919

Tool case · universal



## Single parts from page 124

XX	■	●	Design	Size
1 x	-	-		300 g
1 x	-	-		90 mm
4 x	-	●		0.6x3 · 0.8x4 · 1x5.5 · 1.2x6.5 mm
3 x	-	●		PH0 · PH1 · PH2
9 x	-	●		1.5 · 2 · 2.5 · 3 · 4 · 5 · 6 · 8 · 10 mm
9 x	-	●		T10 · T15 · T20 · T25 · T27 · T30 · T40 · T45 · T50
12 x	-	●		8 · 9 · 10 · 11 · 12 · 13 · 14 · 15 · 16 · 17 · 18 · 19 mm
4 x	6.3 1/4	●		3 · 4 · 5 · 6 mm
3 x	6.3 1/4	●		0.8x4 · 1x5.5 · 1.2x6.5 mm
3 x	6.3 1/4	●		PH1 · PH2 · PH3
3 x	6.3 1/4	●		PZ1 · PZ2 · PZ3

XX	■	●	Design	Size
6 x	6.3 1/4	●		T10 · T15 · T20 · T25 · T30 · T40
16 x	12.5 1/2	●		10 · 11 · 12 · 13 · 14 · 15 · 16 · 17 · 19 · 20 · 21 · 22 · 24 · 27 · 30 · 32 mm
11 x	6.3 1/4	●		4 · 5 · 5.5 · 6 · 7 · 8 · 9 · 10 · 11 · 12 · 13 mm
1 x	-	6.3 1/4		150 mm
1 x	-	12.5 1/2		250 mm
1 x	6.3 1/4	6.3 1/4		40 mm
1 x	12.5 1/2	12.5 1/2		75 mm
1 x	6.3 1/4	6.3 1/4		100 mm
1 x	12.5 1/2	12.5 1/2		125 mm

**V2542**, EAN 4047728**025423**

**Tool case · universal**

• Tool case including assortment



VIGOR No.	Designation	LxWxH mm	EAN
V2400	Case · empty	510x410x140	4047728+ 024006



## Double open-end wrench

- Surface: chrome-plated, polished
- DIN 3110



**NEW**



VIGOR No.	a mm	a2 mm	Size	L mm	EAN 4047728+
V7730-6X7	4.2	4.2	6x7 mm	133	083676
V7730-8X9	5.4	5.4	8x9 mm	149	083683
V7730-10X11	5.5	5.5	10x11 mm	156	083690
V7730-12X13	5.5	5.5	12x13 mm	180	083706
V7730-14X15	6	6	14x15 mm	187	083713
V7730-16X17	6.8	6.8	16x17 mm	205	083720
V7730-18X19	7.7	7.7	18x19 mm	220	083737
V7730-20X22	8.3	8.3	20x22 mm	237	083744
V7730-21X23	8.8	8.8	21x23 mm	250	083751
V7730-24X27	9.8	9.8	24x27 mm	262	083768
V7730-25X28	9.8	9.8	25x28 mm	262	083775
V7730-30X32	10.1	10.1	30x32 mm	293	083782

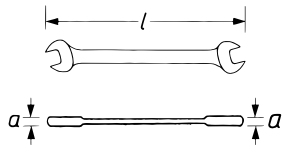

## V7730/12, EAN 4047728084161

### Double open-end wrench set

- Surface: chrome-plated, polished
- DIN 3110



**NEW**



xx	Design	Size
12 x		6x7 · 8x9 · 10x11 · 12x13 · 14x15 · 16x17 · 18x19 · 20x22 · 21x23 · 24x27 · 25x28 · 30x32 mm



## Combination wrench

- Long design
- 15° offset box-end wrench
- Surface: chrome-plated, polished
- DIN 3113 form A



**NEW**

VIGOR No.	a1 mm	a mm	Size	L mm	EAN 4047728+
V7740-6	4.9	4	6 mm	110	083911
V7740-7	5.5	4.1	7 mm	120	083928
V7740-8	5.9	4.5	8 mm	130	083935
V7740-9	6.4	4.6	9 mm	140	083942
V7740-10	7.3	5	10 mm	150	083959
V7740-11	7.6	5.3	11 mm	160	083966
V7740-12	7.8	5.5	12 mm	170	083973
V7740-13	8.6	6	13 mm	180	083980
V7740-14	8.9	6.3	14 mm	190	083997
V7740-15	9.2	6.4	15 mm	200	084000
V7740-16	10	6.8	16 mm	210	084017
V7740-17	10.2	7	17 mm	220	084024
V7740-18	10.5	7.1	18 mm	230	084031
V7740-19	11	7.6	19 mm	240	084048

VIGOR No.	a1 mm	a mm	Size	L mm	EAN 4047728+
V7740-20	12	8.3	20 mm	250	084055
V7740-21	12.1	8.4	21 mm	260	084062
V7740-22	12.3	8.5	22 mm	270	084079
V7740-24	12.8	8.9	24 mm	290	084086
V7740-27	13.8	9.6	27 mm	320	084093
V7740-30	15.3	10.5	30 mm	350	084109
V7740-32	16	11	32 mm	370	084116
V7740-34	17.5	13.5	34 mm	450	084666
V7740-36	17.5	13.5	36 mm	450	084123
V7740-38	18.5	14.5	38 mm	465	084673
V7740-41	18.5	15	41 mm	480	084680
V7740-46	20	15.5	46 mm	490	084697
V7740-50	22	16	50 mm	505	084703

## V7740/15, EAN 4047728084147

### Combination wrench set

- Long design
- 15° offset box-end wrench
- Surface: chrome-plated, polished
- DIN 3113 form A



**NEW**

XX	Design	Size
15 x		6 · 7 · 8 · 9 · 10 · 11 · 12 · 13 · 14 · 15 · 16 · 17 · 18 · 19 · 22 mm



## V7740/22, EAN 4047728084130

### Combination wrench set

- Long design
- 15° offset box-end wrench
- Surface: chrome-plated, polished
- DIN 3113 form A



**NEW**

XX	Design	Size
22 x		6 · 7 · 8 · 9 · 10 · 11 · 12 · 13 · 14 · 15 · 16 · 17 · 18 · 19 · 20 · 21 · 22 · 24 · 27 · 30 · 32 · 36 mm



**V7740/6**, EAN 4047728**084499**

## Combination wrench set

- Long design
- 15° offset box-end wrench
- Surface: chrome-plated, polished
- DIN 3113 form A



**NEW**



VIGOR No.	Design	Size
6 x		34 · 36 · 38 · 41 · 46 · 50 mm



## Double box-end wrench

- 15° offset
- Surface: chrome-plated, polished
- DIN 838, ISO 10104



**NEW**

VIGOR No.	a1 mm	a2 mm	Size	L mm	EAN 4047728+
<b>V7750-6X7</b>	5	5.5	6x7 mm	170	<b>083799</b>
<b>V7750-8X9</b>	5.8	6.2	8x9 mm	184	<b>083805</b>
<b>V7750-10X11</b>	6.8	7.2	10x11 mm	198	<b>083812</b>
<b>V7750-12X13</b>	8	8.5	12x13 mm	218	<b>083829</b>
<b>V7750-14X15</b>	8.5	9	14x15 mm	233	<b>083836</b>
<b>V7750-16X17</b>	9.5	10	16x17 mm	253	<b>083843</b>

VIGOR No.	a1 mm	a2 mm	Size	L mm	EAN 4047728+
<b>V7750-18X19</b>	10	10.5	18x19 mm	266	<b>083850</b>
<b>V7750-20X22</b>	11	12.5	20x22 mm	285	<b>083867</b>
<b>V7750-21X23</b>	12.5	13.5	21x23 mm	310	<b>083874</b>
<b>V7750-24X27</b>	13.5	14.5	24x27 mm	325	<b>083881</b>
<b>V7750-25X28</b>	14	15.5	25x28 mm	345	<b>083898</b>
<b>V7750-30X32</b>	15.5	16.5	30x32 mm	385	<b>083904</b>

**V7750/12**, EAN 4047728**084154**

## Double box-end wrench set

- 15° offset
- Surface: chrome-plated, polished
- DIN 838, ISO 10104



**NEW**



VIGOR No.	Design	Size
12 x		6x7 · 8x9 · 10x11 · 12x13 · 14x15 · 16x17 · 18x19 · 20x22 · 21x23 · 24x27 · 25x28 · 30x32 mm



## Ratcheting combination wrench · short

- 72 teeth
- Opening angle: 5°



VIGOR No.	a1 mm	a2 mm	Size	L mm	EAN 4047728+
V2822	7.4	4.9	8 mm	89	028226
V2823	7.5	5.2	9 mm	93	028233
V2824	8.5	5.5	10 mm	97	028240
V2825	8.4	6.1	11 mm	102	028257
V2826	8.5	6.3	12 mm	106	028264
V2827	8.4	6.7	13 mm	110	028271
V2828	8.4	7	14 mm	114	028288
V2829	8.4	7.4	15 mm	120	028295
V2830	10	7.7	16 mm	122	028301
V2831	10	7.7	17 mm	126	028318
V2832	11.5	8.4	18 mm	131	028325
V2833	11.5	8.6	19 mm	136	028332

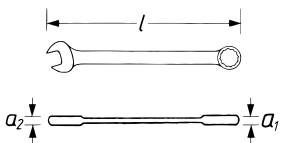

V2821, EAN 4047728028219

## Ratcheting combination wrench set · short

- Delivery in tool roll
- 72 teeth
- Opening angle: 5°



			Design	Size
12 x				8 · 9 · 10 · 11 · 12 · 13 · 14 · 15 · 16 · 17 · 18 · 19 mm





## Ratcheting combination wrench · long

- Surface: chrome-plated, polished
- 72 teeth
- Opening angle: 5°

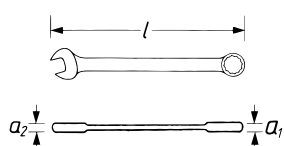

VIGOR No.	$a_1$ mm	$a$ mm	Size	$l$ mm	EAN 4047728+
V3635	7.4	4.6	6 mm	135	036351
V3636	7.4	4.7	7 mm	144	036368
V1008	7.4	4.7	8 mm	140	010085
V1009	7.4	5.3	9 mm	151	010092
V1010	8.4	5.7	10 mm	160	010108
V1021	8.4	6.1	11 mm	165	010214
V1022	8.4	6.4	12 mm	170	010221
V1023	8.4	6.6	13 mm	177	010238
V1025	8.4	7.3	14 mm	192	010252
V1026	8.4	7.5	15 mm	200	010269
V1027	10	7.7	16 mm	210	010276
V1028	10	7.9	17 mm	225	010283
V1029	11.5	8.4	18 mm	235	010290
V1030	11.5	8.7	19 mm	245	010306
V4961	12.5	9	21 mm	275	049610
V4962	13.5	10	22 mm	285	049627
V4963	13.5	11	24 mm	296	049634
V4964	13.5	12	27 mm	340	049641
V4965	16	13	30 mm	369	049658
V4966	16	14	32 mm	395	049665

## V1031, EAN 4047728010313

### Ratcheting combination wrench set · long

- Tool roll
- Surface: chrome-plated, polished
- 72 teeth
- Opening angle: 5°



xx	Design	Size
12 x		8 · 9 · 10 · 11 · 12 · 13 · 14 · 15 · 16 · 17 · 18 · 19 mm

## V2820, EAN 4047728028202

### Ratcheting combination wrench set · long

- Tool roll
- Surface: chrome-plated, polished
- 72 teeth
- Opening angle: 5°



xx	Design	Size
5 x		8 · 10 · 13 · 17 · 19 mm

## Double joint ratcheting combination wrench

- Ratchet head with double joint
- Box-end side with 12-point profile
- 72 teeth
- Opening angle: 5°

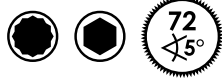

VIGOR No.	$a_1$ mm	$a_2$ mm	Size	L mm	EAN 4047728+
V6752-8	7.4	4.7	8 mm	163	067522
V6752-9	7.4	5.3	9 mm	168	067836
V6752-10	8.4	5.7	10 mm	178	067843
V6752-11	8.4	6.1	11 mm	186	067850
V6752-12	8.4	6.4	12 mm	196	067867
V6752-13	8.4	6.6	13 mm	206	067874
V6752-14	8.4	7.3	14 mm	217	067881
V6752-15	8.4	7.5	15 mm	228	067898
V6752-16	10	7.7	16 mm	245	067904
V6752-17	10	7.9	17 mm	259	068017
V6752-18	11.5	8.4	18 mm	273	068024
V6752-19	11.5	8.7	19 mm	285	068031

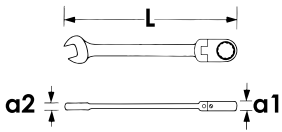

V6752/12, EAN 4047728068048

## Double joint ratcheting combination wrench set

- Ratchet head with double joint
- Box-end side with 12-point profile
- In tool roll
- 72 teeth
- Opening angle: 5°



XX	Design	Size
12 x		8 · 9 · 10 · 11 · 12 · 13 · 14 · 15 · 16 · 17 · 18 · 19 mm

V6752/5, EAN 4047728072113

## Double joint ratcheting combination wrench set

- Ratchet head with double joint
- Box-end side with 12-point profile
- 72 teeth
- Opening angle: 5°



XX	Design	Size
5 x		8 · 10 · 13 · 17 · 19 mm

## Ratcheting combination wrench with hinge

- 72 teeth
- Opening angle: 5°

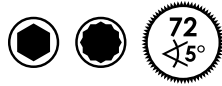

VIGOR No.	a1 mm	a2 mm	Size	L mm	EAN 4047728+
V2804	7.4	5	8 mm	143	028042
V2805	7.4	5.3	9 mm	150	028059
V2806	8.4	5.9	10 mm	158	028066
V2807	8.4	6.1	11 mm	165	028073
V2808	8.4	6.4	12 mm	170	028080
V2809	8.4	6.7	13 mm	182	028097
V2810	8.4	7.4	14 mm	190	028103
V2811	8.5	7.6	15 mm	200	028110
V2812	9.9	7.6	16 mm	215	028127
V2813	10	8	17 mm	228	028134
V2814	11.1	8.2	18 mm	241	028141
V2817	11.5	8.7	19 mm	250	028172

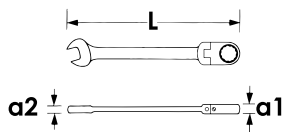

## V2818, EAN 4047728028189

### Ratcheting combination wrench set with hinge

- Tool roll
- Surface: chrome-plated, polished
- 72 teeth
- Opening angle: 5°



	Design	Size
12 x		8 · 9 · 10 · 11 · 12 · 13 · 14 · 15 · 16 · 17 · 18 · 19 mm



**V3607**, EAN 4047728**036078**

**Double ratcheting box-end wrench**

- 72 teeth
- Opening angle: 5°



Multi-purpose profile



10 mm

4 in 1

13 mm



8 mm

12 mm

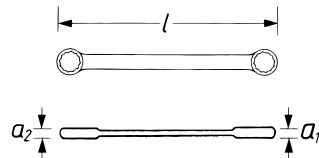

VIGOR No.	$a_1$ mm	$a_2$ mm	Size	$l$ mm	EAN 4047728+
<b>V3607</b>	12.5	14.5	8x12 · 10x13	220	<b>036078</b>



**V2705**, EAN 4047728**027052**

**Double ratcheting box-end wrench**

- 72 teeth
- Opening angle: 5°



12-point



17 mm

4 in 1

19 mm



10 mm

13 mm

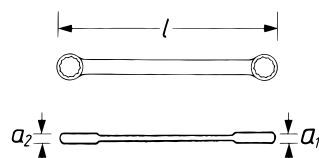

VIGOR No.	$a_1$ mm	$a_2$ mm	Size	$l$ mm	EAN 4047728+
<b>V2705</b>	20	17	10x13 · 17x19	220	<b>027052</b>

**V6611/4**, EAN 4047728073561

## Double ratcheting box-end wrench set

- Tool roll
- Surface: bright chrome-plated
- 72 teeth
- Opening angle: 5°



XX		Design	Size
1 x			E6, E8
1 x			E10, E12
1 x			E14, E18
1 x			E20, E24



## Adjustable wrench

- One-hand wrench size adjustment using the adjustable wheel on the wrench head
- Head set angled at 15°
- Easily legible mm scale on the wrench head



mm scale on the wrench head



Hanging hole



VIGOR No.	L mm	sb mm	EAN 4047728+
V6048	150	24	069625
V6049	250	33	069618

**V7031**, EAN 4047728082624

## Ratcheting box-end wrench · extra long

- At least 60 % longer than standard ratchet wrenches – for greater power transmission
- Slim design
- Tool roll
- Surface: chrome-plated, polished
- 72 teeth
- Opening angle: 5°



**NEW**



XX	Design	Size
10 x		10 · 11 · 12 · 13 · 14 · 15 · 16 · 17 · 18 · 19 mm

**V1208**, EAN 4047728012089

Screwdriver for slotted screws · short

• 5.5x38 mm



**V1209**, EAN 4047728012096

Phillips-Recess screwdriver · short

• PH 2x38 mm



Screwdriver for slotted screws

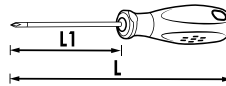

VIGOR No.	Size	L1 mm	L mm	EAN 4047728+
V1698	0.6x3 mm	75	156	016988
V1699	0.8x4 mm	80	161	016995
V1700	1x5.5 mm	125	231	017008
V1701	1.2x6.5 mm	150	256	017015
V3613	1.6x8 mm	150	266	036139
V3609	1.6x10 mm	175	291	036092

Phillips-Recess screwdriver

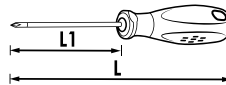

VIGOR No.	Size	L1 mm	L mm	EAN 4047728+
V1702	PH0	75	156	017022
V1703	PH1	80	186	017039
V1704	PH2	100	206	017046
V3610	PH3	150	266	036108

Screwdriver for slotted screws with impact cap

• Manufactured according to DIN/ISO

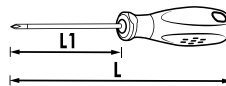

VIGOR No.	Size	L1 mm	L mm	EAN 4047728+
V3597	0.6x3.5 mm	75	157	035972
V3598	1x4.5 mm	100	182	035989
V3599	1x5.5 mm	100	207	035996
V3600	1.2x6.5 mm	125	232	036009
V5042	1.6x8 mm	150	267	050425
V5043	1.6x10 mm	175	297	050432
V5044	2x12 mm	200	317	050449

Phillips-recess screwdriver with impact cap

• Manufactured according to DIN/ISO

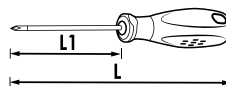

VIGOR No.	Size	L1 mm	L mm	EAN 4047728+
V3601	PH1	182	75	036016
V3602	PH2	207	100	036023
V4667	PH3	200	315	046671

**V4655**, EAN 4047728**046558**

## Screwdriver set

• Manufactured according to DIN/ISO



xx		Design	Size
1 x	⊖		1x5.5 mm
6 x	⊖		0.6x3 · 0.8x4 · 1x5.5 · 1.2x6.5 · 1.6x8 · 1.6x10 mm
1 x	⊕		PH2
4 x	⊕		PH0 · PH1 · PH2 · PH3



**V1637**, EAN 4047728**016377**

## Screwdriver set

• Manufactured according to DIN/ISO



xx		Design	Size
4 x	⊖		0.6x3 · 0.8x4 · 1x5.5 · 1.2x6.5 mm
3 x	⊕		PH0 · PH1 · PH2



**V3562**, EAN 4047728**035620**

## Screwdriver set with impact cap

• Manufactured according to DIN/ISO



With impact cap

6-point



xx		Design	Size
4 x	⊖		0.6x3.5 · 1x4.5 · 1x5.5 · 1.2x6.5 mm
2 x	⊕		PH1 · PH2



**V4432/6**, EAN 4047728073868

**Screwdriver set · extra long**  
 • Working in areas with restricted access

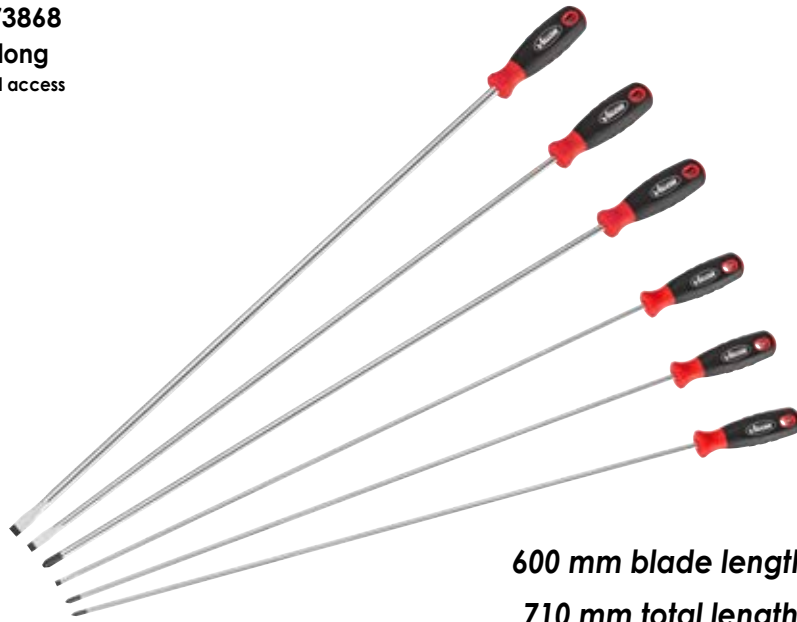

**600 mm blade length**  
**710 mm total length**

VIGOR No.	Designation	Design		Size	L mm	EAN 4047728+
V4436	Screwdriver for slotted screws · extra long			1.2x6 mm	600	073905
V4437	Screwdriver for slotted screws · extra long			1.6x8 mm	600	073912
V4438	Screwdriver for slotted screws · extra long			1.6x10 mm	600	073929
V4433	Phillips-Recess screwdriver · extra long			PH1	600	073875
V4434	Phillips-Recess screwdriver · extra long			PH2	600	073882
V4435	Phillips-Recess screwdriver · extra long			PH3	600	073899





## T screwdriver

• Manufactured according to DIN/ISO

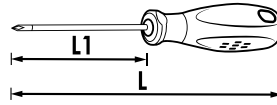

VIGOR No.	Size	L1 mm	L mm	EAN 4047728+
V4419	T6	74	154	044196
V4420	T7	74	154	044202
V4421	T8	74	154	044219
V4422	T9	74	154	044226
V3367	T10	100	206	033671
V3368	T15	100	206	033688
V3369	T20	100	206	033695
V3370	T25	100	206	033701
V3391	T27	100	206	033916
V3392	T30	100	206	033923
V3393	T40	100	206	033930

## V4418, EAN 4047728044189

### T screwdriver set

• Manufactured according to DIN/ISO



XX	Design	Size
4 x		T6 · T7 · T8 · T9

## V3366, EAN 4047728033664

### T screwdriver set

• Manufactured according to DIN/ISO



XX	Design	Size
7 x		T10 · T15 · T20 · T25 · T27 · T30 · T40



## Screwdriver, flexible

- Hose clamps on coolant hoses
- Working even in confined areas that cannot be reached with a conventional screwdriver
- Design with double spiral spring including plastic coating

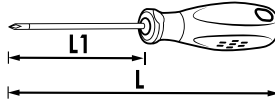

VIGOR No.	Size	L mm	EAN 4047728+
V4664	6 mm	300	046640
V4665	7 mm	300	046657
V4666	8 mm	300	046664

## V5661, EAN 4047728056618

### Screwdriver set · flexible

- Hose clamps on coolant hoses
- Working even in confined areas that cannot be reached with a conventional screwdriver
- Design with double spiral spring including plastic coating



XX	Design	Size
3 x		6 · 7 · 8 mm

## V5485N, EAN 4047728060714

### Screwdriver set · extra long · flexible

- Working in areas with restricted access
- Extra long, length: 500 mm
- Universal 6.3 mm (1/4") screwdriver bit socket
- Universal 6.3 mm (1/4") square
- 7 mm 6-point output



XX	Design	Size
6 x		T10 · T15 · T20 · T25 · T27 · T30
2 x		PH1 · PH2
2 x		1x5.5 · 1.2x6.5 mm
1 x	-	500 mm
1 x	-	500 mm
1 x	-	7 mm
5 x		5 · 6 · 7 · 8 · 10 mm

**V5601**, EAN 4047728056014

**Offset screwdriver set**

- In clip
- Long design
- Ball-head
- Contents: 1.5 · 2 · 2.5 · 3 · 4 · 5 · 6 · 7 · 8 · 10 mm



Size 7 mm included



**V4942**, EAN 4047728049429

**Offset screwdriver set**

- In clip
- Long design
- Ball-head
- Contents: 1.5 · 2 · 2.5 · 3 · 4 · 5 · 6 · 8 · 10 mm



**V4708**, EAN 4047728047081

**T offset screwdriver set**

- In clip
- Long design
- Ball-head
- Contents: T10 · T15 · T20 · T25 · T27 · T30 · T40 · T45 · T50



**V4303**, EAN 4047728**043038**

## Electronic screwdriver set

- Rotating head section and spinning area
- Four screwdrivers for slotted screws 1.6 · 2 · 2.4 · 3 mm
- Two screwdrivers for Phillips-Recess screws PH00 · PH0
- In plastic box



XX		Design	Size
4 x			1.6 · 2 · 2.4 · 3
2 x			PH0 · PH00

**V3427N**, EAN 4047728**058865**

## Bit screwdriver

- For manual operation



6.3 1/4"



## Hex-nut driver

- Surface: chrome-plated



VIGOR No.	Size	L1 mm	EAN 4047728+
V4200	6 mm	150	042000
V4221	7 mm	150	042215
V4222	8 mm	150	042222
V4223	10 mm	150	042239
V4224	12 mm	150	042246
V4225	13 mm	150	042253

**V4199**, EAN 4047728**041997**

## Hex nut-driver set

- Surface: chrome-plated



XX		Design	Size
6 x			6 · 7 · 8 · 10 · 12 · 13 mm

# Screwdrivers and bits



## Hexagon T-handle screwdriver



VIGOR No.	Size	L1 mm	L mm	EAN 4047728+
V2489	2 mm	100	160	024891
V2486	2.5 mm	100	160	024860
V2507	3 mm	100	160	025072
V2506	4 mm	100	160	025065
V2505	5 mm	100	160	025058
V2504	6 mm	132	217	025041
V2503	8 mm	132	217	025034
V2502	10 mm	132	217	025027

## V1409, EAN 4047728014090 6-point T-handle screwdriver set

• Including holder



Included



XX	Design	Size
8 x		2 · 2.5 · 3 · 4 · 5 · 6 · 8 · 10 mm

## T-handle screwdriver



VIGOR No.	Size	L1 mm	L mm	EAN 4047728+
V2498	T9	100	160	024983
V2497	T10	100	160	024976
V2501	T15	100	160	025010
V2490	T20	100	160	024907
V2485	T25	100	160	024853
V2484	T27	132	217	024846
V2483	T30	132	217	024839
V2482	T40	132	217	024822

## V1410, EAN 4047728014106 T-handle screwdriver set



Included



XX	Design	Size
8 x		T9 · T10 · T15 · T20 · T25 · T27 · T30 · T40

## Bit holder with magnetic ring · long

- Strong magnetic ring to secure screws
- Screwdriver bit can be recessed into the holder to create a contact surface for the screw head
- Ideal for hard-to-reach places



VIGOR No.	d1 mm	L mm	EAN 4047728+
V7601-150	15.5	150	079433
V7601-250	15.5	250	079426



**V7600**, EAN 4047728**079440**

### Bit holder with hinge

- 20° angular movement
- Bit holder can be locked in position
- For impact operation



6.3 1/4" 6.3 1/4"

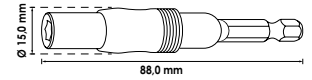

### Socket adapter set

6.3 1/4" 10 3/8" 12.5 1/2" 6.3 1/4"

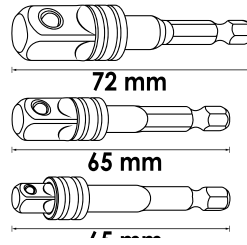

VIGOR No.	EAN 4047728+
V7603/3	079471

### Socket adapter · with hinge

- 20° angular movement
- Socket adapter can be locked in position
- For impact operation

6.3 1/4" 6.3 1/4"



VIGOR No.	mm	EAN 4047728+
V7614	90	079457

### Socket adapter · with hinge

- 20° angular movement
- Socket adapter can be locked in position
- For impact operation

10 3/8" 6.3 1/4"



VIGOR No.	mm	EAN 4047728+
V7638	92	079464

# Screwdrivers and bits

**V5019**, EAN 4047728050197

**Bit box**

• ~ DIN / ISO



XX	■	□	Design	Size
7 x				T10 · T15 · T20 · T25 · T27 · T30 · T40
4 x				3 · 4 · 5 · 6 mm
3 x				PH1 · PH2 · PH3
3 x				PZ1 · PZ2 · PZ3
4 x				0.5x3 · 0.8x4 · 1x5 · 1x6 mm
7 x				T10H · T15H · T20H · T25H · T27H · T30H · T40H
1 x				60 mm
1 x				25 mm



**V5502**, EAN 4047728055024

**Bit box**

• Work with screws in the workshop, industry, trade, at home and for hobby use

• ~ DIN / ISO



XX	■	□	Design	Size
7 x				T10 · T15 · T20 · T25 · T27 · T30 · T40
4 x				3 · 4 · 5 · 6 mm
3 x				PH1 · PH2 · PH3
3 x				PZ1 · PZ2 · PZ3
4 x				0.5x3 · 0.8x4 · 1x5 · 1x6 mm
7 x				T10H · T15H · T20H · T25H · T27H · T30H · T40H
1 x	-			95 mm
1 x				60 mm

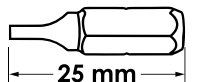



# Screwdrivers and bits



**V5020**, EAN 4047728050203

Bit box

• ~ DIN / ISO



			Design	Size
7 x				T10 · T15 · T20 · T25 · T27 · T30 · T40
2 x				T20H · T25H
3 x				3 · 4 · 5 mm
3 x				PH1 · PH2 · PH3
2 x				PH1 · PH2
3 x				PZ1 · PZ2 · PZ3
2 x				PZ1 · PZ2
3 x				0.5x3 · 0.8x4 · 1x5 mm
1 x				1x6 mm
7 x				T10H · T15H · T20H · T25H · T27H · T30H · T40H
1 x				60 mm
1 x				25 mm

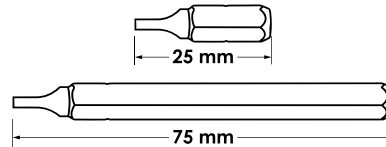

**V6068**, EAN 4047728060684

Bit box

• ~ DIN / ISO



Including sales display for a purchase of at least 10 pieces



			Design	Size
7 x				T10 · T15 · T20 · T25 · T27 · T30 · T40
4 x				3 · 4 · 5 · 6 mm
3 x				PH1 · PH2 · PH3
3 x				PZ1 · PZ2 · PZ3
4 x				0.5x3 · 0.8x4 · 1x5 · 1.2x6.5 mm

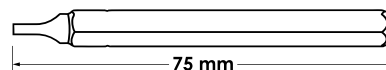

**V7784**, EAN 4047728**077842**

## Ratcheting wrench with screwdriver bit set

- Good accessibility for hard-to-reach places: Screwdriver bits are inserted in the ratchet → ratchet head height very low
- Screwdriver bit assortment with 10 mm hexagon socket
- 2 sockets:  
Rigid side for loosening tight screw connections  
Bit ratchet socket with fine toothing of 72 teeth
- Length of ratcheting wrench: 250 mm



XX	■	●	Design	Size
10 x	10 3/8	⊕		T10 · T15 · T20 · T25 · T27 · T30 · T40 · T45 · T50 · T55
10 x	10 3/8	⊕		T10H · T15H · T20H · T25H · T27H · T30H · T40H · T45H · T50H · T55H
6 x	10 3/8	○		4 · 5 · 6 · 7 · 8 · 10 mm
6 x	10 3/8	○		M4 · M5 · M6 · M8 · M10 · M12
6 x	10 3/8	⊕		M5 · M6 · M7 · M8 · M9 · M10

# Pliers



**V5650**, EAN 4047728056502

## Diagonal cutter with double joint

- Extremely slim design
- For working in areas with restricted access

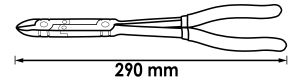

**V2781**, EAN 4047728027816

## Combination pliers with double joint

- Toothed, extremely slim design
- For working in areas with restricted access

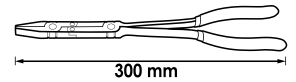

**V2782**, EAN 4047728027823

## Snipe nose pliers with double joint

- Toothed, extremely slim design
- For working in areas with restricted access

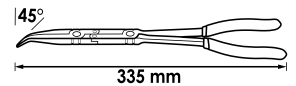

**V2783**, EAN 4047728027830

## Snipe nose pliers with double joint

- Toothed, extremely slim design
- For working in areas with restricted access

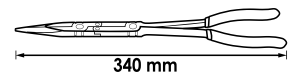

**V5494**, EAN 4047728054942

## Spark plug pliers with double joint

- Installing and removing hard-to-reach spark plug sockets
- Also for severing fuel line connections
- 45° angled head

Safe application thanks to integrated teeth

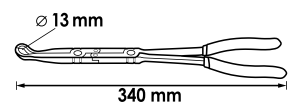

**V6510-10/4**, EAN 4047728076951

Circlip pliers set · 140 mm



xx	Design	Size
1 x		140 mm
1 x		140 mm
1 x		140 mm
1 x		140 mm

**V6510-19/4**, EAN 4047728076968

Circlip pliers set · 180 mm



xx	Design	Size
1 x		180 mm
1 x		180 mm
1 x		180 mm
1 x		180 mm

## Circlip pliers

- For outside lockings
- Form A
- Straight design

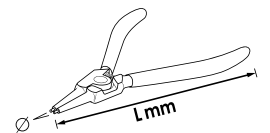

VIGOR No.	● mm	≡ mm	— L — mm	EAN 4047728+
<b>V6510A-10</b>	10-25 mm	1.3	140	<b>076807</b>
<b>V6510A-19</b>	19-60 mm	1.8	180	<b>076814</b>
<b>V6510A-40</b>	40-100 mm	2.3	230	<b>076821</b>

## Circlip pliers

- For outside lockings
- Form B
- Angled

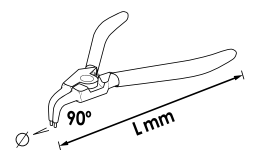

VIGOR No.	● mm	≡ mm	— L — mm	EAN 4047728+
<b>V6510B-10</b>	10-25 mm	1.3	140	<b>076838</b>
<b>V6510B-19</b>	19-60 mm	1.8	180	<b>076845</b>
<b>V6510B-40</b>	40-100 mm	2.3	230	<b>076852</b>

## Circlip pliers

- For inside lockrings
- Form C
- Straight design

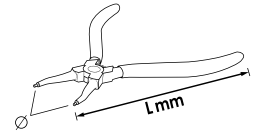

VIGOR No.	⌀ mm	mm	L mm	EAN 4047728+
V6510C-12	12-25 mm	1.3	140	076869
V6510C-19	19-60 mm	1.8	180	076876
V6510C-40	40-100 mm	2.3	230	076883

## Circlip pliers

- For inside lockrings
- Form D
- Angled

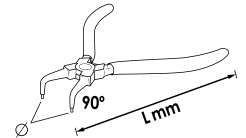

VIGOR No.	⌀ mm	mm	L mm	EAN 4047728+
V6510D-12	12-25 mm	1.3	140	077248
V6510D-19	19-60 mm	1.8	180	076906
V6510D-40	40-100 mm	2.3	230	076913

## Grip pliers with curved jaws

- Safe gripping of nuts or screw heads
- Size adjustment with adjusting screw
- Locking element on handle
- Toothed inside of jaws
- Ergonomically shaped, easy to handle
- Chrome Molybdenum
- Nickel-plated

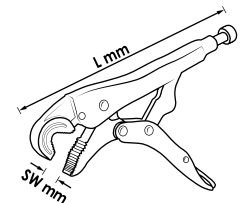

Wire cutter

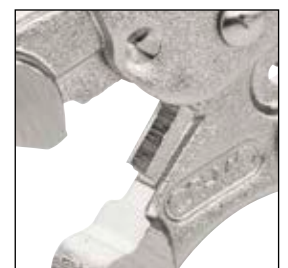

VIGOR No.	Size	L mm	EAN 4047728+
V3738	11 - 19 mm	175	037389
V3739	16 - 27 mm	250	037396

**V1808**, EAN 4047728018081

## Grip pliers set

- Size adjustment with adjusting screw
- Locking element on handle
- Toothed inside of jaws
- Ergonomically shaped, easy to handle
- Chrome Molybdenum
- Nickel-plated



Delivery in practical tool roll



VIGOR No.	Designation	Design	L mm	EAN 4047728+
V1802	Grip pliers with long jaws		150	018029
V1803	Grip pliers with long jaws		250	018036
V1804	Grip pliers with long jaws		125	018043



**V4640**, EAN 4047728081726

## Hose clamp pliers

- For operating hose and spring band hose clamp
- Rotatable jaws for confined spaces
- Locking element for temporary holding of the clamp



**V4637N**, EAN 4047728**075565**

## Hose and spring band clamp pliers

- Operation of self-gripping hose clamps and spring band clamps which are hard to reach
- Bowden cable locking element for temporary holding of the clamp
- Easy release of the lock due to internal spring
- Fatigue-free work due to internal spring in handle
- Total length of bowden cable: 590 mm
- Clamping range: 18–53 mm



**V4737**, EAN 4047728**075572**

## Fuel line pliers

- Operation of hard-to-reach fuel line clutches
- Flexible Bowden cable
- No damage to the clutches and hoses due to proper operation of quick-release fasteners
- Bowden cable locking element facilitates precise adjustment of the range
- Easy release of the lock due to internal spring
- Total length of bowden cable: 590 mm
- Opening width: 30 mm



**V4641**, EAN 4047728**075558**

## Clamp pliers

- Operation of stepless and earless clamps on axle boots (also thermoplast axle boots)
- Precise tightening through even compression



**V6799**, EAN 4047728**067997**

## Flexible hose clamp set

- Disconnecting flexible hose lines
- Secure, adjustable latching
- Maintenance work with petrol, radiator antifreeze, oil, etc.
- Temperature resistance up to 220°C

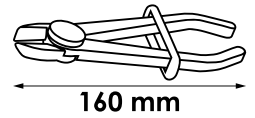
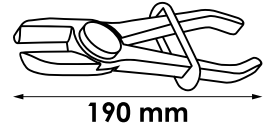
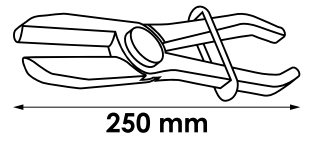

**V3735**, EAN 4047728**037358**

## Hand riveting tool for blind rivets and rivet nuts · universal

- Rivet nuts: M5 · M6 · M8 · M10 for rivets made of copper, brass, steel and stainless steel
- Blind rivets: 3.2 · 4.0 · 4.8 · 6.4 mm for rivets made of copper, brass, steel and stainless steel



## Spare parts

VIGOR No.	Designation	EAN 4047728+
V3735-3.2	Mouthpiece for blind rivets · 3.2 mm	053976
V3735-4.0	Mouthpiece for blind rivets · 4.0 mm	053617
V3735-4.8	Mouthpiece for blind rivets · 4.8 mm	053624
V3735-6.4	Mouthpiece for blind rivets · 6.4 mm	053631
V3735-M5	Mouthpiece for rivet nuts · M5	053495
V3735-M6	Mouthpiece for rivet nuts · M6	053501
V3735-M8	Mouthpiece for rivet nuts · M8	053518
V3735-M10	Mouthpiece for rivet nuts · M10	053525

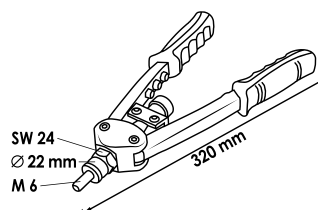



**V2788**, EAN 4047728**027885**

## Blind rivet pliers

- For blind rivets: 3.2 · 4.0 · 4.8 · 6.4 mm
- For rivets made of copper, brass, steel and stainless steel
- Very low power required, extra short design



## Spare parts

VIGOR No.	Designation	EAN 4047728+
V2788-3.2	Mouthpiece for blind rivets · 3.2 mm	053648
V2788-4.0	Mouthpiece for blind rivets · 4.0 mm	053655
V2788-4.8	Mouthpiece for blind rivets · 4.8 mm	053662
V2788-6.4	Mouthpiece for blind rivets · 6.4 mm	053679

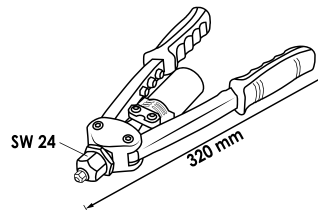

## Pipe wrench

- Robust cast iron pliers body enables high power transmission
- Quick canting and release on the workpiece due to internal spring
- Coarse jaw serration for optimum grip



VIGOR No.	L mm	EAN 4047728+
V5639	350	075589
V5639-24	620	081719

## Universal pliers · with push button

- – Universal pliers –
- Adjustment of the jaw opening at the touch of a button
- Locking of the hinge pin prevents unintentional adjustment

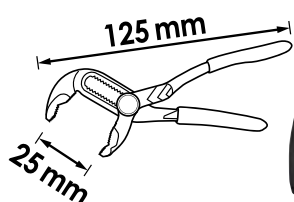

**NEW**



VIGOR No.	L mm	EAN 4047728+
V6504-125	125	082617
V6504-250	250	077750

## Heavy-duty diagonal cutter

2  
K

**NEW**



VIGOR No.	mm	EAN 4047728+
V6500-190	190	084208

## Diagonal cutter

2  
K



VIGOR No.	mm	EAN 4047728+
V6500-140	140	076753
V6500-160	160	076746

## Combination pliers

2  
K



VIGOR No.	mm	EAN 4047728+
V6501-180	180	076760

## Snipe nose pliers

2  
K



VIGOR No.	mm	EAN 4047728+
V6502-200	200	076777

## Snipe nose pliers · angled

2  
K



VIGOR No.	mm	EAN 4047728+
V6503-200	200	076791

**V5632**, EAN 4047728080279

## VDE tool set

- Compact tool case with all the tools needed to safely de-energise a vehicle
- Certified according to DIN EN 60900 up to 1000 volts alternating voltage or 1500 volts direct voltage
- For manual operation

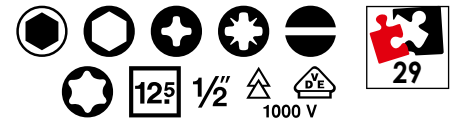

Single parts see page 201

XX	■		Design	Size
3 x	125 1/2	○		5 · 8 · 6 mm
1 x	-	125 1/2		255 mm
9 x	125 1/2	●		8 · 10 · 12 · 13 · 14 · 17 · 19 · 22 · 24 mm
1 x	125 1/2	125 1/2		125 mm
1 x	-	-		200 mm
1 x	-	-		160 mm
1 x	-	-		180 mm
1 x	-	-		251 mm
4 x	-	⊗		T30 · T25 · T20 · T15
4 x	-	⊖		0.5x3 · 0.8x4 · 1x5.5 · 1.2x6.5 mm
3 x	-	⊕		PH0 · PH1 · PH2

**V3343**, EAN 4047728033435

## VDE socket set

- VDE insulated up to 1000 V as per DIN EN 60900
- IEC 60900:2018
- For manual operation

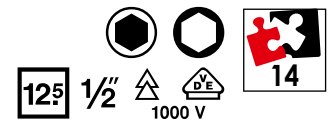

Single parts see page 201

XX	■		Design	Size
9 x	125 1/2	●		8 · 10 · 12 · 13 · 14 · 17 · 19 · 22 · 24 mm
3 x	125 1/2	○		5 · 6 · 8 mm
1 x	125 1/2	125 1/2		125 mm
1 x	-	125 1/2		255 mm

## VDE reversible ratchet

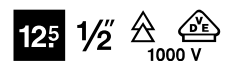

VIGOR No.	mm	EAN
V3342	255	4047728+033428

## VDE extension

**12<sup>5</sup>** 1/2" **12<sup>5</sup>** 1/2" 1000 V



VIGOR No.	mm	EAN 4047728+
<b>V3341</b>	125	<b>033411</b>

## VDE socket

**12<sup>5</sup>** 1/2" 1000 V



VIGOR No.	Size	mm	EAN 4047728+
<b>V3330</b>	8 mm	55	<b>033305</b>
<b>V3331</b>	10 mm	55	<b>033312</b>
<b>V3332</b>	12 mm	55	<b>033329</b>
<b>V3333</b>	13 mm	55	<b>033336</b>
<b>V3334</b>	14 mm	55	<b>033343</b>
<b>V3335</b>	17 mm	55	<b>033350</b>
<b>V3336</b>	19 mm	55	<b>033367</b>
<b>V3337</b>	22 mm	55	<b>033374</b>
<b>V3338</b>	24 mm	55	<b>033381</b>

## VDE screwdriver socket

**12<sup>5</sup>** 1/2" 1000 V



VIGOR No.	Size	mm	EAN 4047728+
<b>V3339</b>	5 mm	78	<b>033398</b>
<b>V3344</b>	6 mm	78	<b>033442</b>
<b>V3340</b>	8 mm	78	<b>033404</b>

## VDE screwdriver for slotted screws

• Manufactured according to DIN/ISO

1000 V

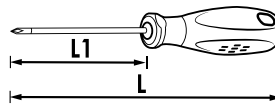

VIGOR No.	Size	L1 mm	mm	EAN 4047728+
<b>V2028</b>	0.5x3 mm	100	181	<b>020282</b>
<b>V2029</b>	0.8x4 mm	100	181	<b>020299</b>
<b>V2030</b>	1x5.5 mm	125	231	<b>020305</b>
<b>V2061</b>	1.2x6.5 mm	150	256	<b>020619</b>

## VDE Phillips-Recess screwdriver

• Manufactured according to DIN/ISO

1000 V

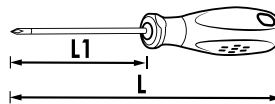

VIGOR No.	Size	L1 mm	mm	EAN 4047728+
<b>V2062</b>	PH0	60	141	<b>020626</b>
<b>V2063</b>	PH1	80	161	<b>020633</b>
<b>V2064</b>	PH2	100	206	<b>020640</b>

## VDE T profile screwdriver

• Manufactured according to DIN/ISO

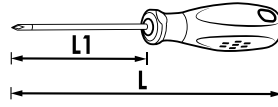

VIGOR No.	Size	L1 mm	L mm	EAN 4047728+
V2031-T15	T15	100	180	078122
V2031-T20	T20	100	180	078115
V2031-T25	T25	125	230	078092
V2031-T30	T30	150	250	078139

## V2027, EAN 4047728020275

### VDE screwdriver set

• Manufactured according to DIN/ISO



XX	Design	Size
4 x		0.5x3 · 0.8x4 · 1x5.5 · 1.2x6.5 mm
3 x		PH0 · PH1 · PH2

## Voltmeter



VIGOR No.	Size	mm	EAN 4047728+
V1138	0.5x3 mm	140	011389

## V5631, EAN 4047728077941

### VDE universal pliers

• VDE insulated up to 1000 V as per DIN EN 60900  
• IEC 60900:2018

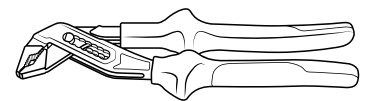
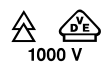

250 mm





**V2641**, EAN 4047728026413

**VDE round nose pliers**

• Long jaws

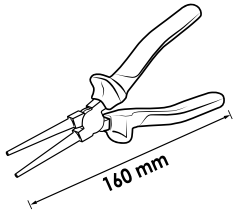

**V2628**, EAN 4047728026284

**VDE combination pliers**

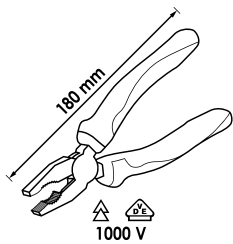

**V2629**, EAN 4047728026291

**VDE diagonal cutter**

• For hard wire (H)

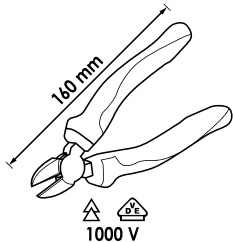

**V2630**, EAN 4047728026307

**VDE snipe nose pliers**

• With blade

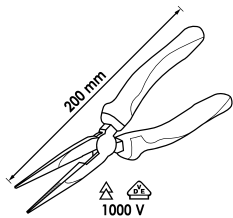

**V2643**, EAN 4047728026437

**VDE wire stripper**

• Spring and adjusting screw

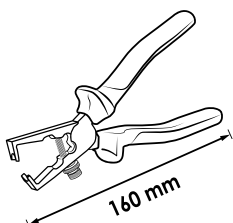

## Machinist's hammer

- Hickory wood
- Rubber impact protection

**NEW**



VIGOR No.	← L → mm	⚖ kg	← L → mm	⚖ kg	EAN 4047728+
V2662-300	300	300 g	300	300 g	084444
V2662-500	320	500 g	320	500 g	084451
V2662-800	350	800 g	350	800 g	084437
V2662-1000	360	1000 g	360	1000 g	084420

## Club hammer

- Hickory wood
- Rubber impact protection

**NEW**



VIGOR No.	← L → mm	⚖ kg	← L → mm	⚖ kg	EAN 4047728+
V2663-1500	280	1500 g	280	1500 g	084383

## Plastic soft-faced hammer

- Replaceable heads made from impact-resistant cellulose acetal
- Ash stick

**MADE IN GERMANY**



VIGOR No.	Diameter max	← L → mm	EAN 4047728+
V1212	32	280	012126
V4661	40	320	046619



VIGOR No.	Designation	∅ mm	EAN 4047728+
V3541	Spare head (pair) for plastic soft-faced hammer V1212	32	035415
V4661-1	Spare head (pair) for plastic soft-faced hammer V4661	40	048514

**V1221**, EAN 4047728012218

Flat chisel

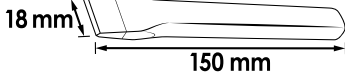

**V1222**, EAN 4047728012225

Cape chisel

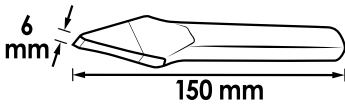

**V1220**, EAN 4047728012201

Centre punch

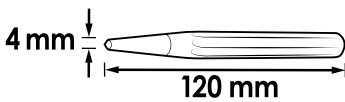

**V1783**, EAN 4047728017831

Centre punch · self-punching

- The impact force is applied by simply pressing down the upper part

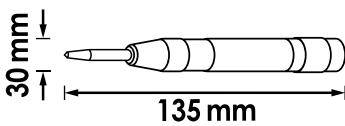

Drift pin



VIGOR No.	∅ mm	L mm	EAN 4047728+
V1214	2	150	012140
V1215	3	150	012157
V1216	4	150	012164
V1217	5	150	012171
V1218	6	150	012188
V1219	8	150	012195



**V1283**, EAN 4047728012836

## Scraper set · stainless steel

- Removing sealing residues on cylinder head lid, valve cover, carburettor cover gaskets, etc.
- Stainless steel blades
- Hanging hole

With impact cap

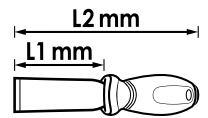

VIGOR No.	L mm	W mm	Chisel height	EAN 4047728+
V2487	230	32	1.2	024877
V2488	230	32	2.5	024884
V2509	175	20	1.2	025096
V2508	175	20	2.5	025089



**V1368N**, EAN 4047728071017

## Universal scraper

- Removal of vignettes, badges and stickers
- Also suitable for ceramic glass cooktop, windscreen, etc.
- Blade can be replaced quickly and safely
- Including one blade

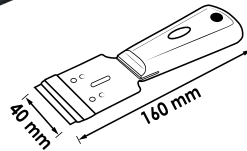

**V1372**, EAN 4047728013727  
Spare blades



**V1213**, EAN 4047728012133

## Gasket scraper · long

- Removing sealing residues on cylinder head lid, valve cover, carburettor cover gaskets, etc.
- Long design
- Plastic handle

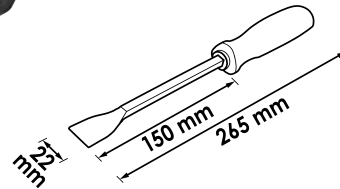

**V4663**, EAN 4047728046633

## Mini hook set

- Inserting and removing O-rings or seals
- Also for removing the protection caps on wheel bolts
- Hanging hole
- Short design

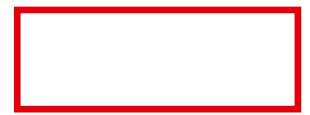
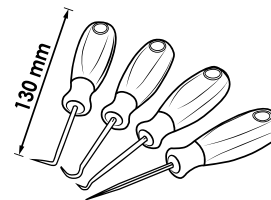

**V5045**, EAN 4047728050456

## Hook and scraper set

- Removing and inserting O-rings and seals and for removing stickers and the remains of seals and adhesive
- Also for removing the protection caps on wheel bolts
- With hanging hole

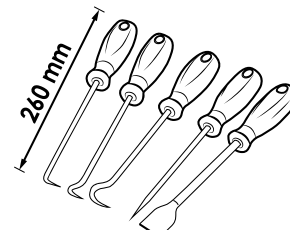

**V6210-4**, EAN 4047728**065948**

## Centre punch

- Labelling of components to be processed
- Ergonomic two-component handle
- Safe gripping
- Reduced vibrations when hitting
- Elongated impact cap
- Tip Ø 4 mm
- Centre punch 4x10x185 mm



**V6210-10**, EAN 4047728**065931**

## Centre punch

- Labelling of components to be processed
- Ergonomic two-component handle
- Safe gripping
- Reduced vibrations when hitting
- Elongated impact cap
- Tip Ø 10 mm
- Centre punch 10x12x185 mm



**V6230-5**, EAN 4047728**065986**

## Cape chisel

- Safe, easy disconnection of components or parts
- Ergonomic two-component handle
- Safe gripping
- Reduced vibrations when hitting
- Elongated impact cap
- Blade width: 5 mm
- Cape chisel 5x10x170 mm



**V6230-7**, EAN 4047728**065993**

## Cape chisel

- Safe, easy disconnection of components or parts
- Ergonomic two-component handle
- Safe gripping
- Reduced vibrations when hitting
- Elongated impact cap
- Blade width: 7 mm
- Cape chisel 7x12x190 mm



## V6200, EAN 4047728061940

### Drift pin set

- Ergonomic two-component handle
- Safe grip
- Significantly reduced risk of injury thanks to hand guard
- Reduced vibrations when hitting
- Elongated impact cap
- 7 different sizes (driving mandrel  $\varnothing$  2 – 8 mm)
- Storage in practical tool roll

VIGOR No.	$\varnothing$ mm	L mm	EAN 4047728+
V6200-2	2	140	061957
V6200-3	3	150	061964
V6200-4	4	180	061971
V6200-5	5	200	061988
V6200-6	6	210	061995
V6200-7	7	210	062008
V6200-8	8	220	062015



## V6220/4, EAN 4047728066006

### Flat chisel set

- Safe, easy disconnection of components or parts
- Ergonomic two-component handle
- Safe gripping
- Reduced vibrations when hitting
- Elongated impact cap
- 4 different sizes: 10 · 16 · 20 · 29 mm
- Storage in practical tool roll

VIGOR No.	L mm	$\frac{+}{-}$ mm	Chisel height	EAN 4047728+
V6220-10	140	10	8	065955
V6220-16	170	16	10	065962
V6220-20	210	20	14	065979
V6220-29	250	29	18	063890



## V6030, EAN 4047728060301

### Scraper set

- Removing badges, stickers, vignettes or adhesive residue, etc.
- Further application fields: removal of motor seals, e.g. on the cylinder head or valve cover
- Blades can be easily replaced by loosening the screw connection on the chuck
- Different blades enable adaptation to different application fields



VIGOR No.	Designation	$\frac{+}{-}$ mm	EAN 4047728+
V6030-12	Spare blades	12	062121
V6030-16	Spare blades	16	062138
V6030-20	Spare blades	20	062145



## V1371, EAN 4047728069687

### Release lever set

- Ideal for working on door panels, dashboards, rubber seals, decorative strips, etc.
- Slim and robust design
- Versatile in use in workshop or household



VIGOR No.	EAN 4047728+
V1371-1	069649
V1371-2	069700
V1371-3	069656
V1371-4	069694
V1371-5	069670
V1371-6	069632
V2491	024914
V2492	024921
V2493	024938
V2494	024945
V2495	024952

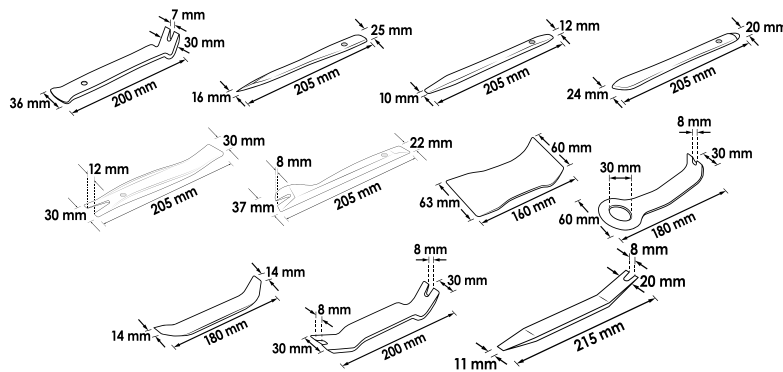

In practical tool roll



## V1369, EAN 4047728013697

### Release lever set

- Ideal for working on door panels, dashboards, rubber seals, decorative strips, etc.
- Does not cause scratches
- Slim and robust design
- Versatile in use in workshop or household



VIGOR No.	mm	mm	EAN 4047728+
V2491	160	60	024914
V2492	180	30	024921
V2493	180	20	024938
V2494	200	30	024945
V2495	210	20	024952

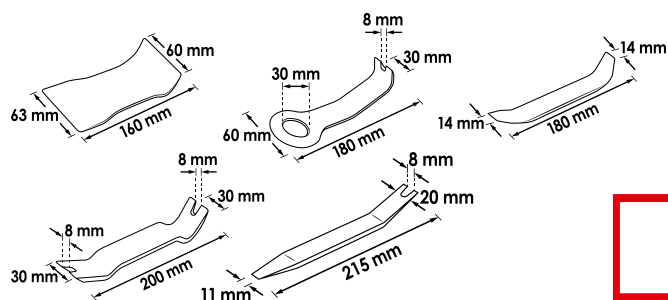

**V4885**, EAN 4047728048859

## Clip loosening set

- Metal and plastic clips of vehicle trims
- Hanging hole

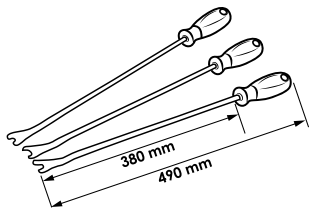

**V5885**, EAN 4047728073851

## Clip loosening set

- Metal and plastic clips of vehicle trims
- Hanging hole

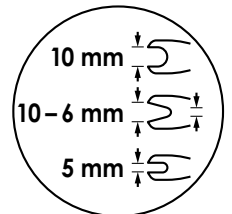
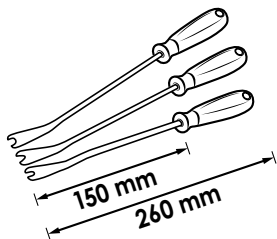

**V4310N**, EAN 4047728062817

## Release lever

- Slim design – for working in areas that are difficult to access e.g. for removing the plastic clips from door and tailgate trims
- Length: 165 mm

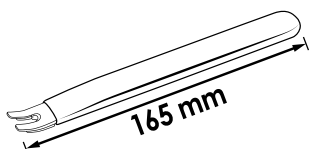

Plastic sleeve for damage-free work



**V1301**, EAN 4047728013017

### Pry bar set

- Impact-resistant handle



**V6952**, EAN 4047728069526

### Mini release lever set

- Replacing the batteries in car keys or working on the dashboard
- Convenient, fine and versatile in use

*Damage-free working on lacquered areas*



	L (mm)
1	190
2	185
3	185
4	165
5	170
6	170



**V5591**, EAN 4047728055918

### Tape measure

- Determining short distances up to 5 m accurate to the millimetre
- Length: 5 m, width: 19 mm
- Wrist strap and belt clip
- Magnetic stopper
- Hand-regulated belt feed and belt stop
- Spring band steel



**V1714**, EAN 4047728017145

### Feeler gauge set

- Testing of gap dimensions, contact gaps, hollow spaces
- Locknut
- Sheets conically shaped
- 20 sheets
- 0.05 – 1.00 mm



# Various hand tools

## Cutting and sawing



**V4690**, EAN 4047728**046909**

### Vernier calliper · analogue

- External and internal measurements in the 0 – 150 mm range
- Millimetre and inch increments
- Nonius 0.05 mm and  $\frac{1}{128}$ "
- Fixing screw
- Dipstick
- In plastic box
- DIN 862



**V1713**, EAN 4047728**017138**

### Vernier calliper · digital

- External and internal measurements in the 0 – 150 mm range
- Millimetre and inch increments
- Digital display
- 1.5 V (LR 44) – 180 mAh
- Fixing screw
- Dipstick
- In plastic box



Can be switched between mm / inches



**V1304**, EAN 4047728**013048**

### Universal scissors

- Long, high-quality cutting edges
- Stainless steel blade

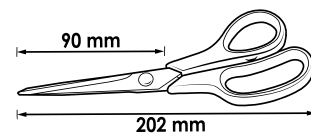

**V1715**, EAN 4047728**017152**

### Saw frame

- Standard saw blades

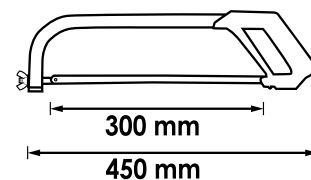

**V2790N**, EAN 4047728075664

**Hack saw · small**

- Standard saw blades

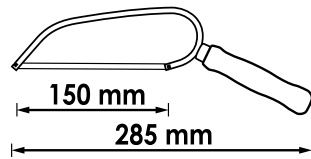

**V4651**, EAN 4047728046510

**Jack-knife · outdoor**

- Blade length: 86 mm
- Total length: 185 mm
- Stainless steel blade
- Aluminium grip housing



With locking element

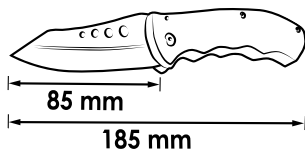

**V2627**, EAN 4047728026277

**Universal knife**

- Snap-off blade 9 mm
- Housing made of stainless steel
- Pocket clip

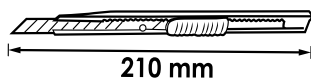

**V4308**, EAN 4047728043083

**Snap-off blades · 9 mm**

- Blades consist of 12 individual blades, which can be easily separated after wearing down
- For universal knife V2627





**V4275**, EAN 4047728**042758**

## Universal knife

- Anti-slip convenient handle
- Steel-guided blade fixed for minimising accidents
- Quick-change magazine
- Includes 6 snap-off blades (V4274)

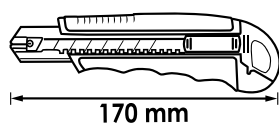

**V4274**, EAN 4047728**042741**

## Snap-off blades · 18 mm

- Blades consist of eight individual blades, which can be easily separated after wearing down
- For universal knife V4275



**V7099**, EAN 4047728**070997**

## Universal jack-knife

- Universal use in the warehouse, garden, household, workshop or in industry
- Foldable, therefore reduced risk of injury
- Blade lock in open position
- Fast blade changes
- High-quality aluminium housing

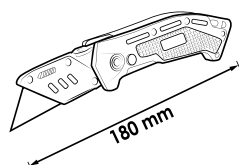

**V1446**, EAN 4047728**014465**

## Trapezoid spare blades

- Can be used in two different ways due to trapezoidal shape
- For universal knife V1345 · V7099
- With two location notches



**V7099/2**, EAN 4047728**071123**

## Universal jack-knife set

- Universal use in the warehouse, garden, household, workshop or in industry
- Foldable, therefore reduced risk of injury
- Blade lock in open position
- Fast blade changes
- High-quality aluminium housing

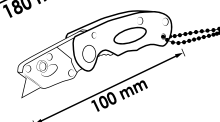
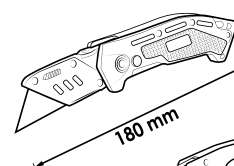

**V1787**, EAN 4047728017879

**Flat hand file**

- Teeth (cut): 2 = medium
- DIN 7261

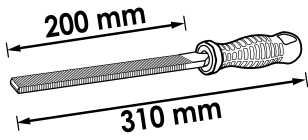

**V1788**, EAN 4047728017886

**Three square file**

- Teeth (cut): 2 = medium
- DIN 7261

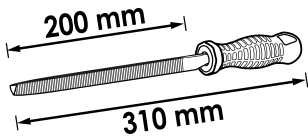

**V1789**, EAN 4047728017893

**Square file**

- Teeth (cut): 2 = medium
- DIN 7261

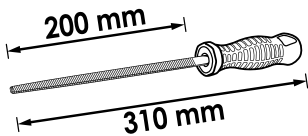

**V1790**, EAN 4047728017909

**Half-round file**

- Teeth (cut): 2 = medium
- DIN 7261

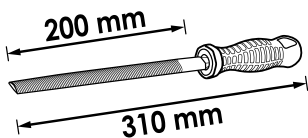

**V1801**, EAN 4047728018012

**Round file**

- Teeth (cut): 2 = medium
- DIN 7261

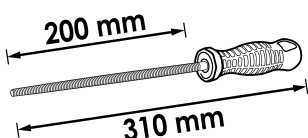

**V2626**, EAN 4047728026260

Ø 3 – 16 mm

### Tube cutter

- For tubes made of copper, brass, light metal and PVC rigid



**V3309**, EAN 4047728033091

### Ratcheting tube cutter for exhaust pipe

- For cutting stainless steel, steel, copper and aluminium
- Ratchet function:
  - Allows work even in hard-to-reach places
  - No need to guide the cutting handle around the pipe
- Working range: 32 – 67 mm
- Cutting depth: 3 mm



**V3451**, EAN 4047728034517

### Spare blades

- Spare blades for ratcheting exhaust pipe cutter V3309



**V1707**, EAN 4047728017077

### HSS step drill set

VIGOR No.	Ø mm	L mm	EAN 4047728+
V2394	4-12	65	023948
V2395	4-20	75	023955
V2396	4-30	100	023962



**V6809-4**, EAN 4047728067720

### Steel wire brush · 4 rows

- Steel working
- Steel bristles
- Wire: 0.30 mm



**V6807-4**, EAN 4047728067713

### Brass wire brush · 4 rows

- Gentle handling of sensitive surfaces
- Brass bristles
- Wire: 0.30 mm



**V6800-50**, EAN 4047728**067621**

## Cup brush · coarse

- Removal of coarse sediments and residues as well as stubborn rust
- Steel wire
- 6 mm clamping shaft
- Maximum 4500 rpm
- 50 mm Ø
- Trim size: 17 mm

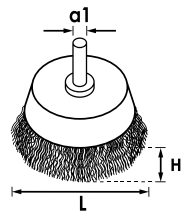

**V6800-75**, EAN 4047728**067638**

## Cup brush · coarse

- Removal of coarse sediments and residues as well as stubborn rust
- Steel wire
- 6 mm clamping shaft
- Maximum 4500 rpm
- 75 mm Ø
- Trim size: 20 mm

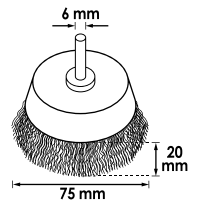

**V6802**, EAN 4047728**067645**

## Wire end brush

- Deburring, paint removal, rust removal and cleaning
- Steel wire
- 25 mm Ø
- 6 mm clamping shaft
- Maximum 4500 rpm

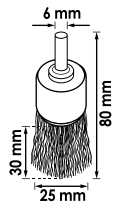

**V6803-100**, EAN 4047728**067669**

## Wheel brush

- Removal of tempered colour on weld seams
- Steel wire
- 6 mm clamping shaft
- Maximum 4500 rpm
- 100 mm Ø

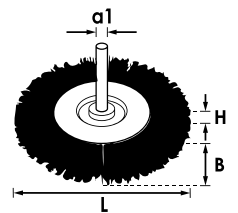

**V6803-75**, EAN 4047728**067652**

## Wheel brush

- Removal of tempered colour on weld seams
- Steel wire
- 6 mm clamping shaft
- Maximum 4500 rpm
- 75 mm Ø

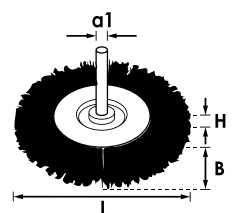

**V6806**, EAN 4047728067676

## Wheel brush · knotted wire

- Removal of coarse sediments and residues as well as stubborn rust or scaling
- Steel wire
- Design with knotted wire
- 75 mm Ø
- Maximum 12500 rpm

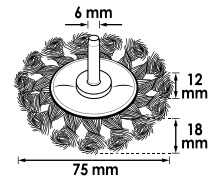

**V6804**, EAN 4047728067690

## Wheel brush

- Deburring, paint removal, rust removal and cleaning
- Hardened steel wire
- Design with knotted wire
- 115 mm Ø
- Maximum 12500 rpm

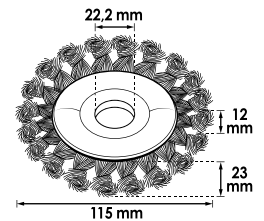

**V6805**, EAN 4047728067706

## Bevel brush

- Cone-shaped for hard-to-reach areas
- Hardened steel wire
- Design with knotted wire
- 100 mm Ø
- Thread: M14x2.0
- Maximum 12500 rpm

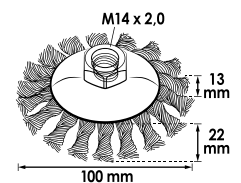

**V6801-65**, EAN 4047728067683

## Cup brush

- Heavy brushing on large surfaces as well as for deburring, derusting and cleaning
- Steel wire
- Design with knotted wire
- 65 mm Ø
- Thread: M14x2.0
- Maximum 12500 rpm

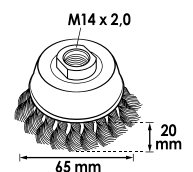

## Torque tools

### Torque tools: precision you can feel

When it comes to precision, our torque tools make no compromises. Ideal for anyone who needs to demonstrate not only strength but also dexterity at work. Our torque wrenches and associated products guarantee that every tightening operation is carried out with exactly the right torque.

Our tools are known for their precision and reliability – having been made from materials that can withstand even the most demanding conditions. From fine mechanics to heavy industrial applications – these tools deliver consistent results you can rely on.

Whether you're working on engines or machine parts, our torque tools help you to carry out your work with a level of precision that makes the difference between good and excellent.

Ensure that every connection fits perfectly – with our precise torque tools.

# Torque wrenches



## Torque wrench

- Torque release: palpable and audible
- Release accuracy tolerance  $\pm 4\%$  of scale value (in direction of actuation)
- With serial number and certificate
- DIN EN ISO 6789-2:2017, DIN 3120, ISO 1174-1A
- 72 teeth
- Opening angle:  $5^\circ$



Torque technology  
"Made in Germany"

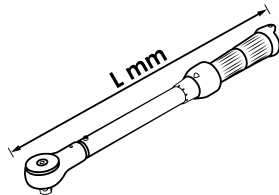

No more turning back

VIGOR No.	Nm	12.5 1/2	L mm	Accuracy	EAN 4047728+
V3898	20 - 120	12.5 1/2	445	4	038980
V3441	40 - 200	12.5 1/2	540	4	034418
V3899	60 - 320	12.5 1/2	610	4	038997

### Fine-tooth reversible ratchet



### Scale graduation: 1 Nm



### Double scale: Nm and lbf.ft.



### Handle with suspension lug



## V2795, EAN 4047728027953

### Rotation angle tester

- Fine resolution ( $0.1^\circ$ )
- Rotation angle range up to  $999^\circ$  (adding)
- Angle measurement in clockwise and anti-clockwise direction
- Memory capacity up to 99 readings
- Indication of battery charge
- LED alarm indication (flashing)
- Buzzer alarm indication
- Audible alarm signal
- Automatic switch-off function





## **Pneumatic tools: power meets control**

Discover the power and precision of our pneumatic tools! This category offers high-performance solutions for anyone who doesn't want to compromise between power and precision in their workshop. From impact wrenches to air ratchets and die grinders – our pneumatic tools are known for their reliable and efficient performance.

The advantages are obvious: faster work processes, less fatigue and improved work quality. Our pneumatic tools are designed to deliver consistently high performance – even under demanding conditions. The ergonomic design ensures comfortable handling and safety in every application.

Whether you work in the automotive industry, construction or metalworking – our pneumatic tools offer the power and precision you need to realise your projects efficiently and with the highest quality.

## **Pneumatic tools**

<b>Impact wrenches</b>	<b>223–224</b>
<b>Air ratchets</b>	<b>225</b>
<b>Die grinder</b>	<b>226</b>
<b>Pneumatic air blow and body protection guns</b>	<b>227</b>
<b>Hose reel</b>	<b>228</b>



# Impact wrenches



**V5671N**, EAN 4047728**076715**

## Mini impact wrench

- Compact design for areas with restricted access
- Multiple power settings in forward and reverse with one-hand adjustment
- Exhaust air is guided downwards through the handle
- Cold insulated handle
- High performance single hammer striking mechanism
- Ergonomically shaped handle and housing for improved handling and operation
- Bumper on the housing side protects the air motor

Maximum loosening torque:  
1200 Nm



12<sup>5</sup> 1/2"

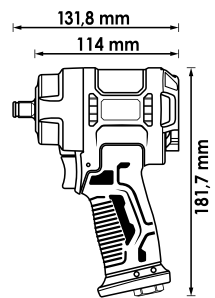

12,91 (6) 7,2

Coupler plug included

VIGOR No.	12 <sup>5</sup> 1/2"	max. Nm	Nm	Nm	1/min	kg	Ø mm	l/min	bar	dB (A)	m/s <sup>2</sup>	EAN 4047728+
<b>V5671N</b>	12 <sup>5</sup> 1/2"	850	600	1200	10000	1,28	10	141,5	6,3	95,3	6,81	<b>076715</b>

**V4800N**, EAN 4047728**075633**

## Impact wrench

- Exhaust air is guided downwards through the handle
- Cold insulated handle
- High performance twin hammer mechanism
- Ergonomically shaped handle and housing for improved handling and operation
- Bumper on the housing side protects the air motor

**ECOGIANT**



12<sup>5</sup> 1/2"



High performance  
twin hammer  
mechanism

Maximum loosening torque:  
1720 Nm

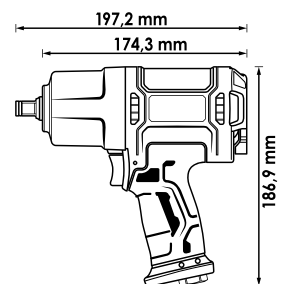

12,91 (6) 7,2

Coupler plug included

VIGOR No.	12 <sup>5</sup> 1/2"	max. Nm	Nm	Nm	1/min	kg	Ø mm	l/min	bar	dB (A)	m/s <sup>2</sup>	EAN 4047728+
<b>V4800N</b>	12 <sup>5</sup> 1/2"	1100	850	1720	7000	2,3	10	198,1	6,3	96,7	6,47	<b>075633</b>

**V6899N**, EAN 4047728076944

## Impact wrench

- Multiple power settings in forward and reverse with one-hand adjustment
- Cold insulated handle
- Exhaust air is guided downwards through the handle
- High performance twin hammer mechanism
- Ergonomically shaped handle and housing for improved handling and operation
- Bumper on the housing side protects the air motor

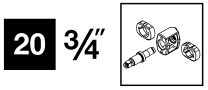

**High performance twin hammer mechanism**

**Maximum loosening torque:  
2300 Nm**

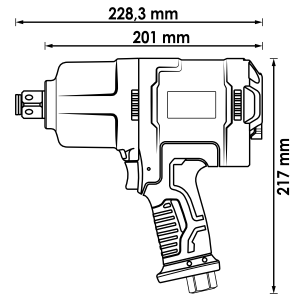

12.91 (w) 7.2

Coupler plug included

VIGOR No.	20 3/4"	max. Nm	Nm	Nm	1/min	kg	Ø mm	l/min	bar	dB (A)	m/s <sup>2</sup>	EAN 4047728+
V6899N	20 3/4"	2000	1400	2300	5500	3.6	13	254.8	6.3	97.9	5.75	076944

**V3653**, EAN 4047728036535

## Impact wrench

- Multiple power settings in forward and reverse with one-hand adjustment
- Exhaust air is guided downwards through the handle
- Cold insulated handle
- High performance twin hammer mechanism
- Ergonomically shaped handle and housing for improved handling and operation

**GIGA GIANT**

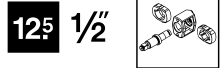

**High performance twin hammer mechanism**

**Maximum loosening torque:  
1890 Nm**

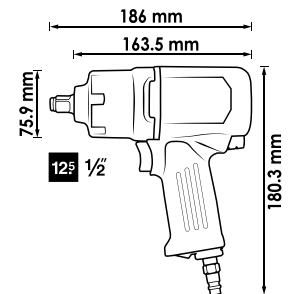

Multiple power settings in forward and reverse with one-hand reversing switch



12.91 (w) 7.2

Coupler plug included

VIGOR No.	125 1/2"	max. Nm	Nm	Nm	1/min	mm	kg	Ø mm	l/min	bar	dB (A)	m/s <sup>2</sup>	EAN 4047728+
V3653	125 1/2"	1290	700	1890	8500	186	1.95	10	113	6.3	96	12.92	036535

# Air ratchets



**V5674**, EAN 4047728**056748**

## Air ratchet

- For areas with restricted access
- Reversing switch on ratchet head

**QUICK GIANT**



**6.3** 1/4"

12.91 (w) 7.2

Coupler plug included

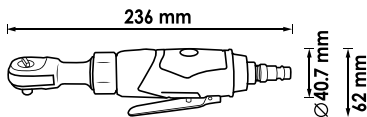

VIGOR No.	Pressure	max. Nm	1/min	L mm	kg	Ø mm	l/min	bar	dB (A)	m/s <sup>2</sup>	EAN 4047728+
<b>V5674</b>	<b>6.3</b> 1/4"	35,2	240	236	0,6	10	77	6,3	87,5	3,47	<b>056748</b>

**V6554**, EAN 4047728**065542**

## Air ratchet

- For areas with restricted access
- Reversing switch on ratchet head

**QUICK GIANT**



**10** 3/8"

12.91 (w) 7.2

Coupler plug included

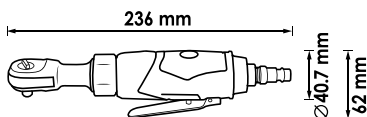

VIGOR No.	Pressure	max. Nm	1/min	L mm	kg	Ø mm	l/min	bar	dB (A)	m/s <sup>2</sup>	EAN 4047728+
<b>V6554</b>	<b>10</b> 3/8"	35,2	240	236	0,6	10	77	6,3	87,5	3,47	<b>065542</b>

**V5675**, EAN 4047728**056755**

## Air ratchet

- For areas with restricted access
- Reversing switch on ratchet head

**QUICK GIANT**



**12.5** 1/2"

12.91 (w) 7.2

Coupler plug included

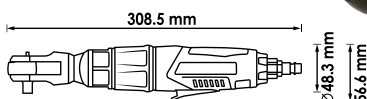

VIGOR No.	Pressure	max. Nm	1/min	L mm	kg	Ø mm	l/min	bar	dB (A)	m/s <sup>2</sup>	EAN 4047728+
<b>V5675</b>	<b>12.5</b> 1/2"	67	160	308,5	1,2	10	114	6,3	100,5		<b>056755</b>



## V5672, EAN 4047728056724

### Die grinder · straight design

- Cutter, cutting wheels, grinding pads with 3 and 6 mm collet chuck

3 + 6 mm



Including Ø 3 mm collet chuck      Including Ø 6 mm collet chuck

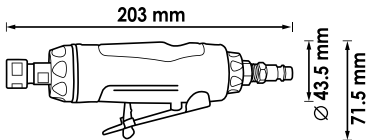

12.91 (w) 7.2

Coupler plug included



VIGOR No.	mm	1/min	mm	W Watt	kg	Ø mm	l/min	bar	dB (A)	m/s <sup>2</sup>	EAN 4047728+
V5672	3-6 mm	22000	203	350	0,54	10	128,2	6,3	97,1	2,90	056724

## V5673, EAN 4047728056731

### Die grinder · angled

- Cutter, cutting wheels, grinding pads with 3 and 6 mm collet chuck

3 + 6 mm



Including Ø 3 mm collet chuck      Including Ø 6 mm collet chuck

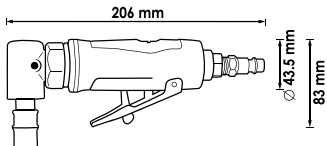

12.91 (w) 7.2

Coupler plug included



VIGOR No.	mm	1/min	mm	W Watt	kg	Ø mm	l/min	bar	dB (A)	EAN 4047728+
V5673	3-6 mm	20000	206	250	0,45	10	85,5	6,3	101,6	056731

## V6906, EAN 4047728069069

### Die grinder set · mini

- Straight design
- Small design for areas with restricted access
- For grinding, polishing or deburring
- Including 3 and 6 mm collet chuck
- Exhaust air is guided downwards through the handle
- Including 10-piece grindstone set V6906-10

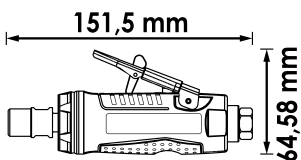

12.91 (w) 7.2

Coupler plug included

## V6906-10, EAN 4047728069571

### Grindstone set

- Grinding stones for VIGOR die grinders V6906 · V5672 · V5673



VIGOR No.	mm	1/min	W Watt	kg	Ø mm	l/min	bar	dB (A)	EAN 4047728+
V6906	3-6 mm	25000	185	0,31	10	85	6,3	102	069069

**V6905**, EAN 4047728069052

## Tyre inflator

- One-hand operation with ergonomic handle
- Rubber-coated manometer for protecting against small impacts
- Easily legible precision manometer with bar and PSI display
- Graduation: 0.1 bar
- Easily adjustable filling lever and discharge button, easy to reach on the handle
- Discharge button for levelling the filling capacity



**FILL GIANT**

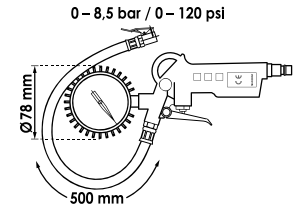

**V7135**, EAN 4047728071352

## Air blow gun · short

- Fast removal and cleaning of chips and other foreign objects
- Long-life aluminium housing
- Suspension device incorporated

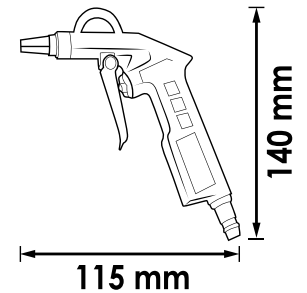

**V7135-150**, EAN 4047728071369

## Air blow gun · long

- Fast removal and cleaning of chips and other foreign objects
- Long-life aluminium housing
- Suspension device incorporated

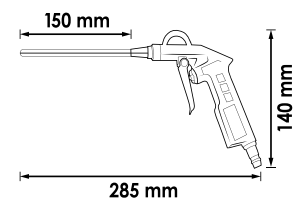
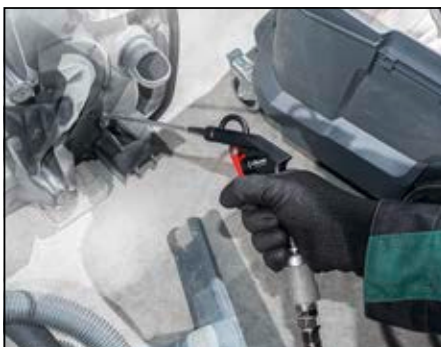

**V7143-10**, EAN 4047728**071437**

## Hose reel

- Reduces danger of accident, as there is no hose lying around
- Compact housing including opening flap for the removal of dirt or to straighten the hose
- Wall holder: 180° pivotable
- Automatic roll up through guided feed
- Pneumatic adapter pre-installed
- Hybrid polymer hose
- Auto stop function
- Impact-resistant polypropylene housing
- Adapted pull-in force
- Maximum working pressure: 12 bar

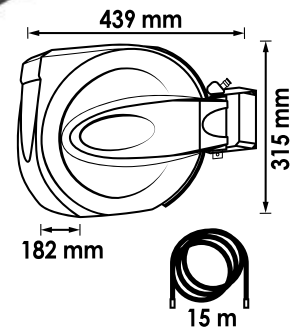

**V4322**, EAN 4047728**043229**

## Underbody protection gun

- Can be used with all common cartridges of 1000 ml
- The flexible 500 mm hose supplied with nozzle for spreading wax allows for an effortless application of wax in hollow spaces
- Simple application of the underbody protection (or noise protection) with nozzle installed as standard
- Application recommendation: Open cartridge, insert suction tube, tighten cartridge. Complete.



12,91 (ø) 7,2

Coupler plug included



## General workshop tools



### General workshop tools: everything your workshop needs

Complete your workshop with our extensive assortment of general workshop tools. From a set of tweezers to a safety walking platform, from kneeling mats to work gloves – we cover all the needs arising in your professional workshop.

Our products are carefully selected to guarantee quality and reliability. Whether you're carrying out regular maintenance or tackling special projects, the right workshop tools are crucial for efficient and trouble-free operation.

Browse here and find everything you need for the daily operation of your workshop. With our general workshop tools, you're always well equipped and ready for any challenge that everyday workshop life brings.

**V4241**, EAN 4047728**042413**

## Control cabinet key Sub Maker Quadro 10-in-1

- For almost all standard locking systems in plumbing, heating, construction, ventilation, air conditioning etc.

- |                 |        |        |
|-----------------|--------|--------|
|                 |        |        |
| 5 mm            | 6-7 mm | 8-9 mm |
|                 |        |        |
| 5-6 mm          | 6-7 mm | 8-9 mm |
|                 |        |        |
| 2 x 1/4"<br>Bit | 3-5 mm | 1/4"   |



**MADE IN GERMANY**



**V4228**, EAN 4047728**042284**

## Site key MasterKey construction

- For standard locking systems in plumbing, heating, construction, ventilation, air conditioning etc.
- Square mandrel allows the lock follower to be operated without a door handle or square pin

- |      |         |      |      |
|------|---------|------|------|
|      |         |      |      |
| 3 mm | 5 mm    | 6 mm | 8 mm |
|      |         |      |      |
| 9 mm | 6-10 mm |      |      |



**MADE IN GERMANY**

Zinc pressure casting



**V4227**, EAN 4047728**042277**

## Site key MasterKey electronics

- For almost all standard locking systems in plumbing, electronics, heating, ventilation, air conditioning etc.

- |      |        |      |
|------|--------|------|
|      |        |      |
| 5 mm | 6 mm   | 8 mm |
|      |        |      |
| 9 mm | 3-5 mm |      |



**MADE IN GERMANY**

Zinc pressure casting





**V4279**, EAN 4047728**042796**

## Set of Japan spatulas · metal

- Applying material or smoothing surfaces, as well as for use in several other application fields
- Width of spatula 50 · 80 · 100 · 120 mm



*Made from highly flexible spring steel strip*



**V4278**, EAN 4047728**042789**

## Set of Japan spatulas · plastic

- Applying material or smoothing surfaces, as well as for use in several other application fields
- For work on the body, e.g. filling holes and dents as well as several other application fields
- Width of spatula 50 · 80 · 100 · 120 mm



**V5480**, EAN 4047728**054799**

## Telescopic inspection mirror set

- Visual inspection in areas with restricted access
- Double joint with tension spring for a view of hard to reach areas
- Replaceable mirror thanks to quick change system with 6.3 mm socket

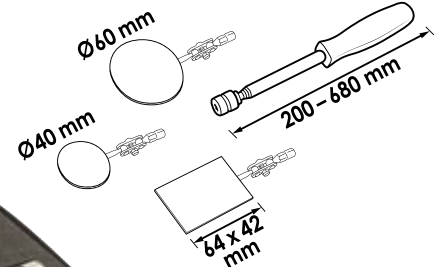

Mirror changeable using quick-change system



Quick identification of e.g. oil loss, corrosion or cable connections



**V1741**, EAN 4047728017411

## Telescope magnetic pick-up tool

- Picking up parts containing iron even in inaccessible parts
- Telescoping
- Practical bag clip

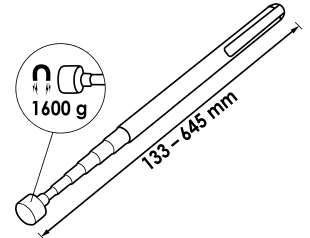

**V1764**, EAN 4047728017640

## Pick-up tool with claws and magnet · flexible

- For picking up small parts such as screws, nuts, etc. at inaccessible places
- With magnet for additional grip
- Gripping and magnetic function

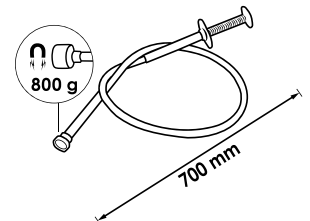

**V1438**, EAN 4047728014380

## Tweezers set

- Ideal for working e.g. in hard-to-reach areas
- Easy grip
- Stainless steel



**V5512**, EAN 4047728055123

## Gas soldering iron set

- Soldering, melting, shrinking and hot cutting work with seven different adapters
- Flexible, stand-alone use due to gas operation
- Device combines three functions into one:
  - Soldering iron, maximum temperature: 450 °C
  - Burner, maximum temperature: 1300 °C
  - Hot air blower, maximum temperature: 600 °C
- Small and easy to handle for working directly on the vehicle, for example
- Continuous gas regulation for optimum adaptation to the work to be carried out and the material
- Flame temperature maximum: 1300 °C
- Stand for stationary working conditions
- Piezo ignition
- Filling with commercial lighter / ISO butane gas
- Content:
  - Gas soldering iron
  - Soldering tip 3.5 mm
  - Soldering tip 4.5 mm
  - Heat-shrink tubing extension
  - Cutting tip
  - Soldering sponge protection cap
  - Solder wire



Improved solder tips



Fill level indicator



Gas valve



Stainless steel



Can be used flexibly everywhere with gas operation



**V5488**, EAN 4047728054881

## Multifunctional drain pan · 50 l

- Used as a cleaning pan, dirt pan, oil pan, storage pan, disinfection pan, leakage pan, transport pan and feed pan e.g. in sanitary and heating construction, the motor vehicle industry and workshops, for hunting equipment, chemical/laboratory use, food industry/butcherries, fishing, pet supplies, horse accessories, etc.
- Alkaline-resistant and acid-resistant

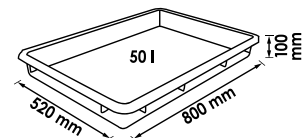

Universal application with huge capacity



**V5677**, EAN 4047728056779

## Magnetic cup with plastic frame

- Two strong magnets for fixing to car lifts, tool trolleys, machinery, etc.
- Setting aside small magnetic and non-magnetic parts – free hands for work
- Plastic frame offers storage space for plastic screws etc. and also serves as a catch tray
- Small parts are stored so they are clearly visible and easy to find again

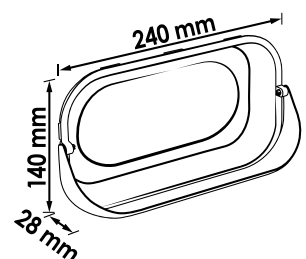

A little helper for great organisation



**V5678**, EAN 4047728070539

## Magnetic half shell

- Holds screws, seals or small parts
- Fixation to tool trolleys, car lifts or metal cabinets
- For the workshop, production facilities or hobby room
- Solid plastic housing with optimised magnets
- Large opening for good view into the half shell
- Rubber housing on magnets prevents damage
- Magnetic cup magnetic on both sides – magnetic small parts adhere to back panel
- Additional stabilisation below the magnets for straight laying of the half shells
- Magnetic holding force: approx. 2.5 kg

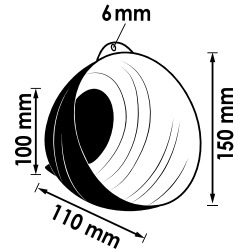

**V6468**, EAN 4047728064682

## Nozzle adjusting tool with magnet

- Nozzle adjustment of windscreen washing systems
- Additional function as magnetic pick-up tool
- Pocket clip



Narrow insert pin  $\varnothing$  0.6 mm

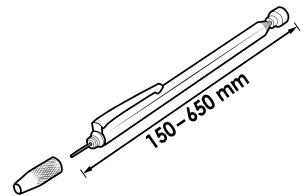

**V6742**, EAN 4047728067423

## Magnetic tool holer

- Storage of impact sockets, impact wrenches, torque wrenches or hoses directly on site
- Strong magnets (each with  $\varnothing$  80 mm) guarantee a good hold on car lifts, tool trolleys or other substructures containing iron
- Magnetic holding force: approx. 20 kg



*Optimal storage of impact sockets and impact wrenches directly on site*

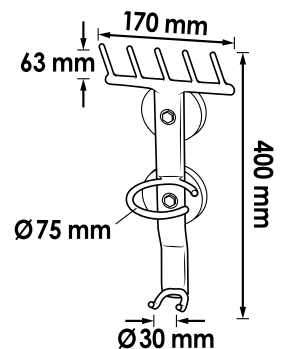

**V6605**, EAN 4047728066051

## Fender cover

- Protection from dents, scratches, oil and dirt
- One size fits all
- Does not cover wheels

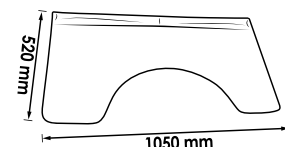

**V6606**, EAN 4047728066068

## Reusable seat cover

- Protection of car seat against heavy soiling
- One size fits all, for most passenger cars and common commercial vehicles
- Light nylon, PU-coated
- Water, grease and oil repellent
- Contents: 1 piece
- Washable at 40°C

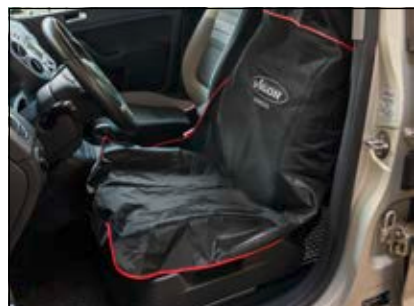

Dimensions:  
L: 1350 x W: 760 mm



**V5531**, EAN 4047728055314

## Single-hand mini window pane holder

- For lifting, carrying and holding
- Adjusting and setting mirror glass
- One-hand operation using lever
- Loading capacity maximum: 8 kg



With release button

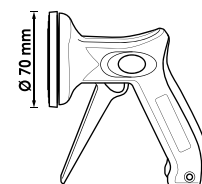

## Work gloves

- Assembly work in the workshop, warehouse / logistics and anywhere where secure grip and precision are important
- Light polyester woven gloves with ergonomic fit
- EN 388:2003 (3131A)



**Black PU coating on the palms**

VIGOR No.	Glove size	EAN 4047728+
V6435	9 / L	064354
V6435-XL	10 / XL	069984

## Gloves · Grip

- Protect hands from oil, grease, chemicals and dirt
- Surface structure provides good adhesion, even in oily working conditions
- Safety colour orange for better visibility in dark work spaces
- Comfortable, tear-resistant glove with good dexterity
- Touchscreen compatible
- Material: Nitrile
- Material thickness: 7 mil (corresponds to 0.18 mm)
- Latex and powder free



VIGOR No.	XX	Glove size	EAN 4047728+
V6436-M	100	8 / M	080118
V6436-L	100	9 / L	077712
V6436-XL	90	10 / XL	077729
V6436-XXL	90	11 / XXL	077736

**V2338**, EAN 4047728**023382**

## Kneeling mat

- Comfortable working in the workshop, in industry, in the garden or in the household
- High-quality foam
- Knee-protecting
- Heat insulating
- Water and oil repellent
- With carrying handle



**Comfortable and low-impact working in the workshop, in industry, in the garden or in the household**

**V6973**, EAN 4047728**069731**

## Mechanic's creeper

- Padded head rest
- Two side storage compartments for screws or other small parts
- High-quality finish made of plastic
- Easy to clean
- Six castors made of hard plastic
- Loading capacity maximum 150 kg

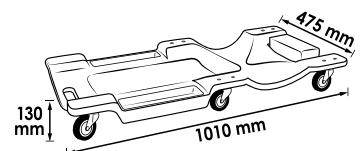

**V6973-1**, EAN 4047728**069748**

## Replacement castor for mechanic's creeper



**V4646**, EAN 4047728**046466**

## Brush set

- Professional cleaning and deburring of cylinders, tubes, bushings, etc.
- For drilling machines and pneumatic drills (When operating with power tools only use the brushes rotating clockwise)
  - 12 nylon brushes:
    - Ø 8 · 9 · 10 · 11 · 12 · 13 · 14 · 15 · 16 · 17 · 18 · 19 mm
  - 12 steel brushes:
    - Ø 8 · 9 · 10 · 11 · 12 · 13 · 14 · 15 · 16 · 17 · 18 · 19 mm
  - 12 brushes with brass coating:
    - Ø 8 · 9 · 10 · 11 · 12 · 13 · 14 · 15 · 16 · 17 · 18 · 19 mm
  - 1 handle with adapter and quick lock
  - 1 extension 150 mm

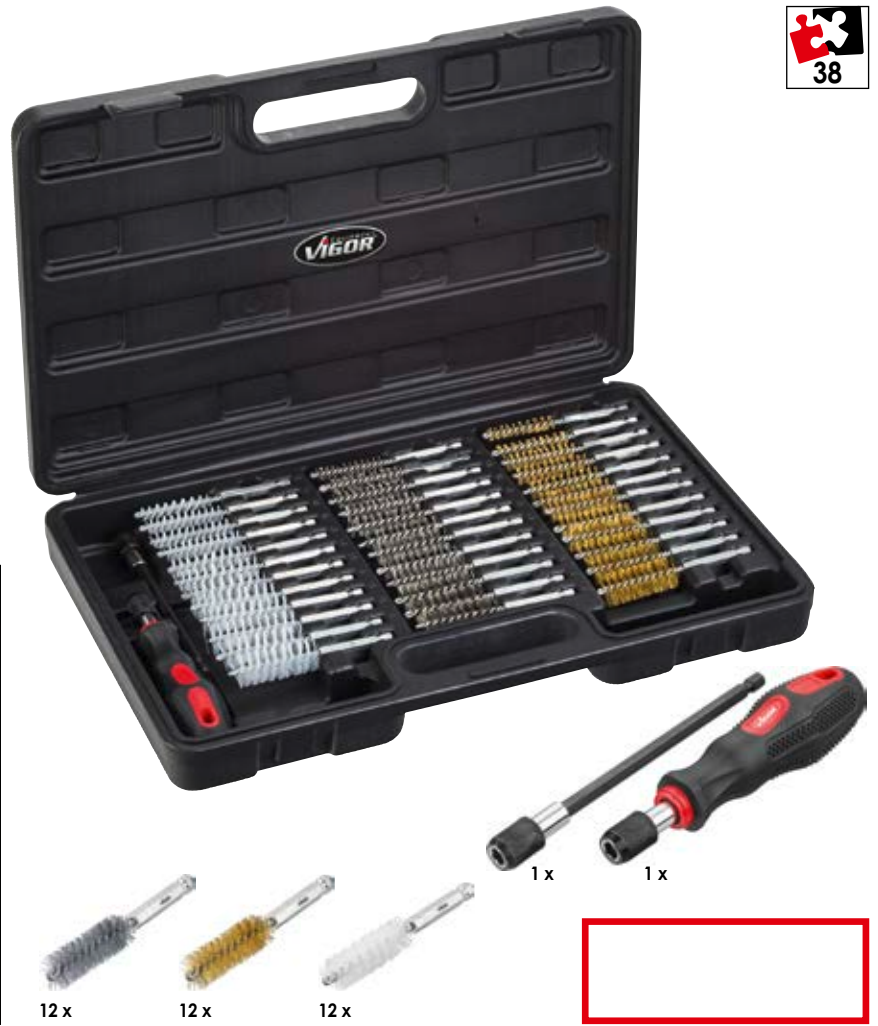
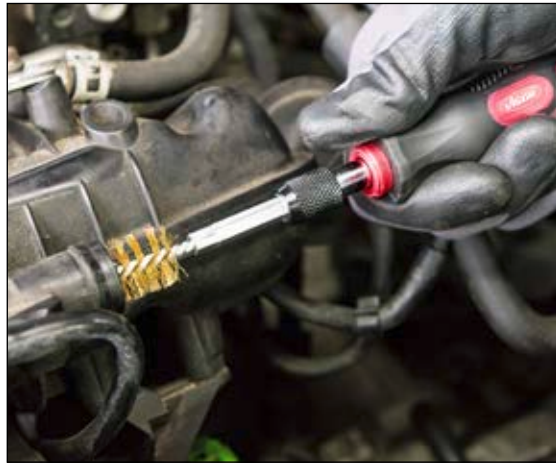

Spare parts 10 pieces per pack

VIGOR No.	Designation	EAN 4047728+
V4646M-8	Brass brush set Ø 8 mm	054102
V4646M-9	Brass brush set Ø 9 mm	054119
V4646M-10	Brass brush set Ø 10 mm	054126
V4646M-11	Brass brush set Ø 11 mm	054133
V4646M-12	Brass brush set Ø 12 mm	054140
V4646M-13	Brass brush set Ø 13 mm	054157
V4646M-14	Brass brush set Ø 14 mm	054164
V4646M-15	Brass brush set Ø 15 mm	054171
V4646M-16	Brass brush set Ø 16 mm	054188
V4646M-17	Brass brush set Ø 17 mm	054195
V4646M-18	Brass brush set Ø 18 mm	054201
V4646M-19	Brass brush set Ø 19 mm	054218
V4646N-8	Nylon brush set Ø 8 mm	054225
V4646N-9	Nylon brush set Ø 9 mm	054232
V4646N-10	Nylon brush set Ø 10 mm	054249
V4646N-11	Nylon brush set Ø 11 mm	054256
V4646N-12	Nylon brush set Ø 12 mm	054263
V4646N-13	Nylon brush set Ø 13 mm	054270

VIGOR No.	Designation	EAN 4047728+
V4646N-14	Nylon brush set Ø 14 mm	054287
V4646N-15	Nylon brush set Ø 15 mm	054294
V4646N-16	Nylon brush set Ø 16 mm	054300
V4646N-17	Nylon brush set Ø 17 mm	054317
V4646N-18	Nylon brush set Ø 18 mm	054324
V4646N-19	Nylon brush set Ø 19 mm	054331
V4646S-8	Steel brush set Ø 8 mm	053587
V4646S-9	Steel brush set Ø 9 mm	053594
V4646S-10	Steel brush set Ø 10 mm	053600
V4646S-11	Steel brush set Ø 11 mm	054010
V4646S-12	Steel brush set Ø 12 mm	054027
V4646S-13	Steel brush set Ø 13 mm	054034
V4646S-14	Steel brush set Ø 14 mm	054041
V4646S-15	Steel brush set Ø 15 mm	054058
V4646S-16	Steel brush set Ø 16 mm	054065
V4646S-17	Steel brush set Ø 17 mm	054072
V4646S-18	Steel brush set Ø 18 mm	054089
V4646S-19	Steel brush set Ø 19 mm	054096

## Outside deburrer

- For deburring screws and threads and for adjusting deformed drive shafts, steering tie rods or stud bolts on wheel hubs
- Hexagon drive, 6.3 mm
- Rotation speed: 0 – 500 rpm
- Cutting plates made of high-strength tungsten steel
- Suitable for the following materials:
  - Stainless steel
  - Steel
  - Brass
  - Non-ferrous metal
  - Plastics

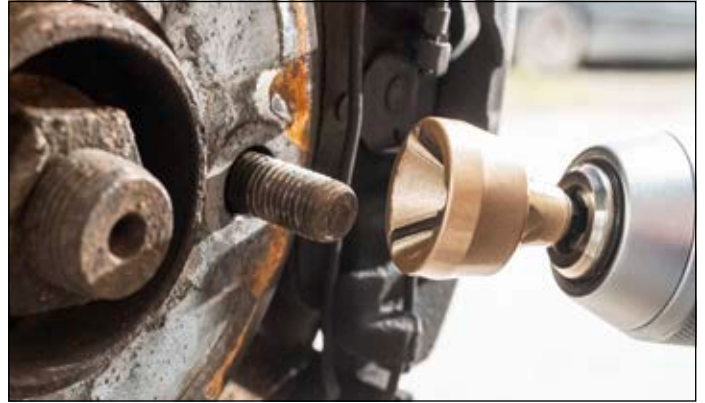
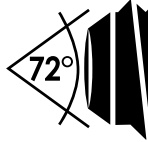

V7402



V7403



VIGOR No.	Ø mm	EAN 4047728+
V7402	3-19	074025
V7403	13-35	074032

## V4638, EAN 4047728046381

### Safety platform · aluminium

- Lightweight
- Safety locking on both feet
- Maximum loading capacity: 150 kg
- Weight: 7.2 kg



Space saving collapsible

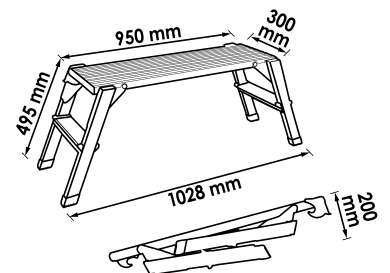



## Diagnostics / battery / electrical system: precise technology for fault-free operation

In today's technically advanced vehicle world, precise diagnostics are indispensable. Our selection of diagnostic and electrical tools ensures that you can quickly recognise and rectify faults. Whether it's battery testing, troubleshooting in electrical systems or vehicle diagnostics – we have the right tools for any challenge.

Our products are tailored to the requirements of modern vehicles – offering technologies that not only save time, but also deliver precise results. Our multimeters, video borescopes, battery cell testers and other specialty tools ensure you're ideally equipped to solve electrical and electronic problems effectively.

Rely on our high-quality diagnostic tools to ensure the health and safety of your vehicle's electrical system. From routine checks to comprehensive system diagnostics – our tools support you in keeping every vehicle in top form.

## Diagnostics / Battery / Electrical System

Video borescope	240–241
Flue gas leakage tester	242
Electrical system	243, 245–246
Multimeter	243
Cable release tools	244
Crimping pliers set	245



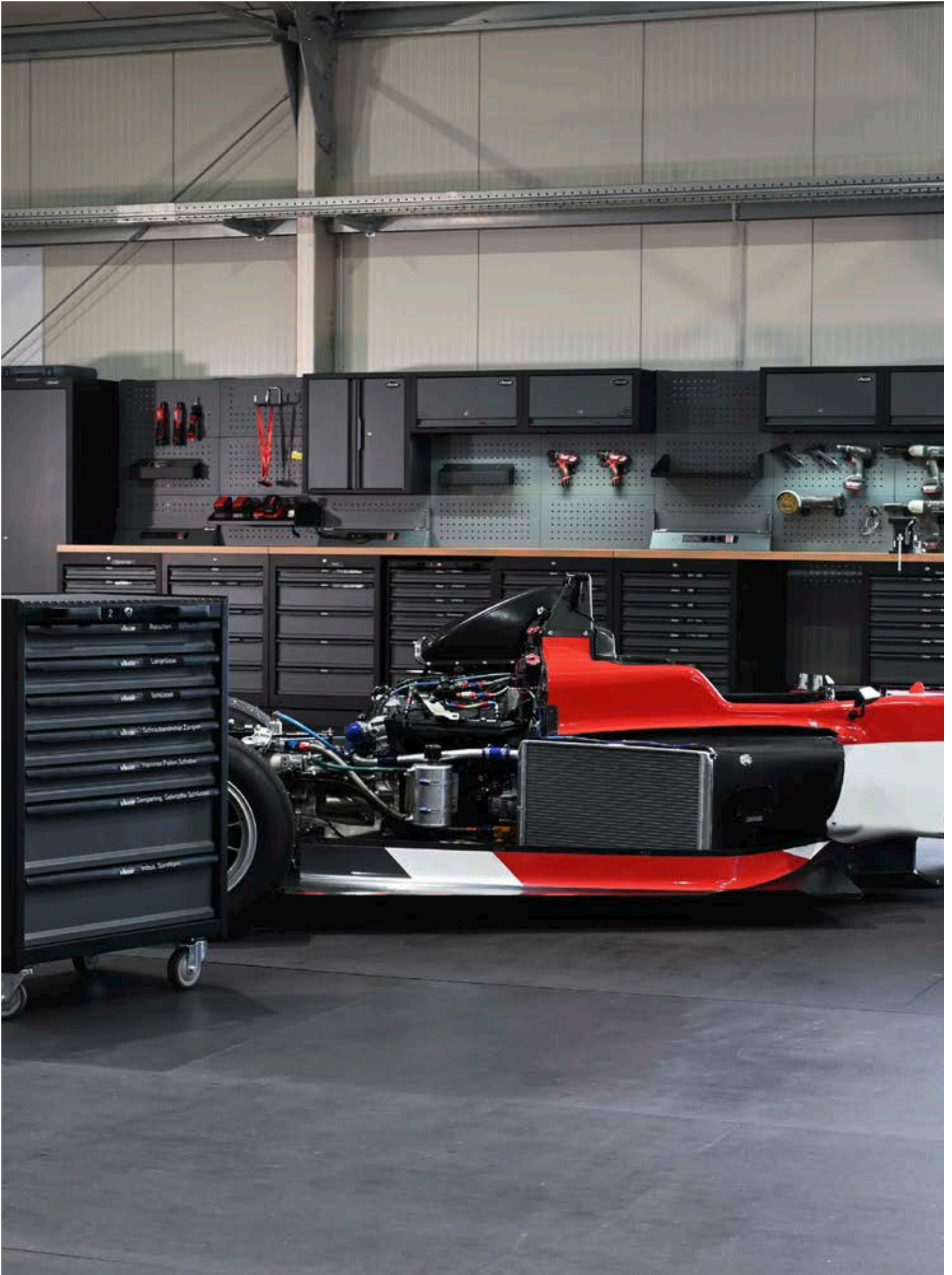

## Video borescope

- Analysis and documentation of damage patterns in difficult to access spaces
- Error documentation for customer communication
- Probe length: 1000 mm
- Probe protection rating: IP67
- Camera resolution: 1280x720 pixels
- Camera viewing angle: 80°
- 6 dimmable LEDs
- Depth of field: 20 – 80 mm
- 5 inch display, swivelling
- Display resolution: 1280x720 pixels
- 5 Ah, 3.7 V Li-ion rechargeable battery
- Power supply unit 2 A · 5 V, USB charging cable and 32 GB TF memory card included in delivery



1280x720 pixels



VIGOR No.	Designation	EAN 4047728+
V7501-39	Video borescope with Ø 3.9 mm probe	082037
V7501/2	Video borescope with Ø 4.9 mm probe	080255



**V7524**, EAN 4047728081320

## Flue gas leakage tester

- Leakage detection in closed systems
- Leaks are quickly visualised through the application of flue gas
- Operation via the 12 V on-board power supply
- Pressurisation by means of "air" mode and integrated manometer possible without further aids
- Smoke generation with suitable aid (vegetable glycerine 99.5% or baby care oil)
- Universal application option thanks to various adapters
- Built-in air compressor
- Automatic safety shutdown in case of imminent overheating
- Infinitely adjustable air flow
- Diverse application possibilities, for example:
  - Intake and boost pressure system
  - Crankcase
  - Exhaust gas and exhaust gas recirculation system
  - Fuel system
  - Adblue and additive system
  - Tyres
  - Air conditioning system
  - EVAP fuel system (US vehicles)
  - Car body and glazing (wind noise, moisture penetration, etc.)

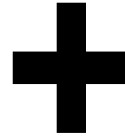

VIGOR No.	Designation	Design	EAN 4047728+
V7524-1	Power cable		081474
V7524-2	Smoke hose		081481
V7524-3	Conical adapter		081504
V7524-4	Valve extractor		081528
V7524-5	Air bellows adapter		081535
V7524-6	Hard rubber plug		081542
V7524-7	Plug for small lines		081559
V7524-8	Cover caps, red		081566
V7524-9	EVAP connection adapter		081573



**V7524-10**, EAN 4047728084321

## Diagnostic liquid

- Ready-to-use diagnostic liquid for the generation of dense, white and odourless vapour in the Vigor V7524 flue gas leakage tester
- The liquid is non-toxic and biodegradable
- The quantity of 250 ml is sufficient for numerous applications



**NEW**



# Electrical system Multimeter



**V4324**, EAN 4047728**043243**

## Digital multimeter

- Compact and practical
- High-contrast, one-line LCD display including backlighting
- 19-position rotary switch
- Reliable warning thanks to automatic overflow and polarity display for preventing possible errors
- Stand-up positioning including protective rubber cover
- Measuring cable with protection against contact
- DC: 200 mV – 600 V
- AC: 200 V – 600 V
- DC: 200 mA – 10 A
- Resistance: 200 – 2000 Ohm
- Diode tester
- Maximum display: 1999
- 9 V battery (in device)
- Fuses:
  - 1 x 250 mA / 250 V
  - 1 x 10 A / 250 V
- Multimeter for testing quiescent current
- Used with measuring cable set V4326
- Functions:
  - Direct and alternating voltage measurements
  - Direct and alternating current measurement
  - Resistance measurement
  - Diode test (with acoustic signal)
  - Passage inspection (with acoustic signal)
  - Data hold function



VIGOR No.	Designation	EAN 4047728+	
<b>V4324-1</b>	Fuses - 5 pieces	<b>053532</b>	
<b>V4324-2</b>	Measuring cable for V4324	<b>053549</b>	

**V1722**, EAN 4047728**017220**

## Car light tester

∠ 6 – 24 V

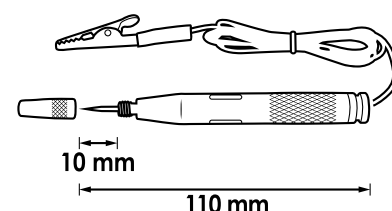

**V4451**, EAN 4047728**044516**

## Cable release tool set

- Damage-free release of electrical plugs and connectors e.g. with ABS, air conditioning sensors, radio, PDC, trailer coupling modules, etc.
- Fast trouble-shooting with corrosion or connection defects
- For round and flat connectors



*Indispensable for mechatronics technicians  
and motor vehicle electricians*

VIGOR No.	Designation	Design	EAN 4047728+
V4451-1	Individual cable release tool 1 · BMW · MERCEDES-BENZ · OPEL/VAUXHALL · VW/AUDI		053693
V4451-2	Individual SYSTEM cable release tool 2 · BMW · JAGUAR · MERCEDES-BENZ · PORSCHE · SAAB · SEAT · ŠKODA		053709
V4451-3	Individual SYSTEM cable release tool 3 · BMW · MERCEDES-BENZ · OPEL/VAUXHALL · PORSCHE · VW/AUDI		053716
V4451-4	Individual SYSTEM cable release tool 4 · FORD		053723
V4451-5	Individual cable release tool 5 · BMW · FORD · MERCEDES-BENZ · OPEL/VAUXHALL · PORSCHE · SEAT · ŠKODA · VW/AUDI		053730
V4451-6	Individual cable release tool 6 · BMW · FORD · JAGUAR · OPEL/VAUXHALL · MERCEDES-BENZ · PORSCHE · SAAB · SEAT · ŠKODA · VW/AUDI		053747
V4451-7	Individual SYSTEM cable release tool 7 · MERCEDES BENZ		053754
V4451-8	Individual cable release tool 8 · FORD · JAGUAR · MERCEDES-BENZ · OPEL/VAUXHALL · PORSCHE · VW/AUDI		053761
V4451-9	Individual cable release tool 9 · FORD · MERCEDES BENZ		053815
V4451-10	Individual SYSTEM cable release tool 10 · MERCEDES BENZ		053822
V4451-11	Individual cable release tool 11 · BMW · FORD · JAGUAR · MERCEDES-BENZ · OPEL/VAUXHALL · PORSCHE · SAAB · SEAT · ŠKODA · VW/AUDI		053839
V4451-12	Individual cable release tool 12 · OPEL/VAUXHALL · RENAULT · ŠKODA · VW/AUDI		053846
V4451-13	Individual cable release tool 13 · FORD · MERCEDES BENZ		053853
V4451-14	Individual cable release tool 14 · FORD · JAGUAR · PORSCHE		053860
V4451-15	Individual cable release tool 15 · BMW · FORD · MERCEDES-BENZ · OPEL/VAUXHALL · SEAT · ŠKODA · VW/AUDI		053877
V4451-16	Individual cable release tool 16 · BMW · FORD · JAGUAR · MERCEDES-BENZ · OPEL/VAUXHALL · PORSCHE · VW/AUDI		053884
V4451-17	Individual SYSTEM cable release tool 17 · BMW		053891
V4451-18	Individual SYSTEM cable release tool 18 · MERCEDES BENZ		053907
V4451-19	Individual cable release tool 19 · CITROËN · FIAT · CHRYSLER · FORD · HONDA · MAZDA · OPEL/VAUXHALL · MERCEDES-BENZ · MITSUBISHI · PORSCHE · RENAULT · SEAT · TOYOTA · VW/AUDI		053914
V4451-20	Individual SYSTEM cable release tool 20 · FORD		053921
V4451-21	Individual cable release tool 21 · BMW · FORD · JAGUAR · MERCEDES-BENZ · OPEL/VAUXHALL · PORSCHE · SAAB · SEAT · ŠKODA · VW/AUDI		053938
V4451-22	Individual cable release tool 22 · HONDA · OPEL/VAUXHALL · TOYOTA · VW/AUDI		053945
V4451-23	Individual cable release tool 23 · OPEL/VAUXHALL · VW/AUDI		053952



# Crimping pliers set Electrical system



**V2499**, EAN 4047728024990

## Crimping pliers set

- Five replaceable crimping sockets:
- Crimping socket A: for insulated cable lugs from 0.5 – 6.0 mm<sup>2</sup> (red, blue, yellow)
- Crimping socket B: for closed, non-insulated cable lugs of 1.5 · 2.5 · 6.0 · 10 mm<sup>2</sup>
- Crimping socket C: for open, non-insulated cable lugs from 0.5 – 6.0 mm<sup>2</sup> (width up to 6.3 mm)
- Crimping socket D: for wire end sleeves with or without collar from 0.5 – 4.0 mm<sup>2</sup>
- Crimping socket F: for wire end sleeves above 6.0 mm<sup>2</sup>

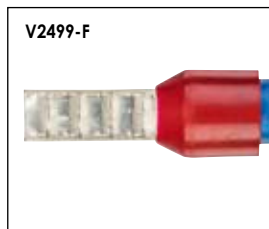
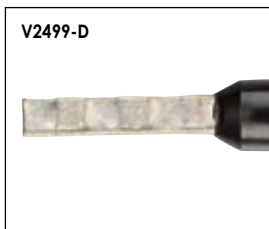
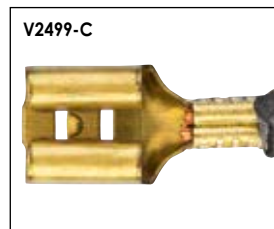
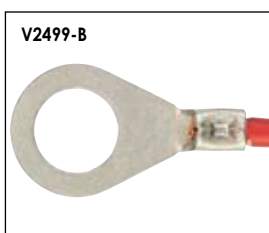

## Spare parts

VIGOR No.	Designation	Design	EAN 4047728+
<b>V2499-A</b>	Crimping socket A: for insulated cable lugs from 0.5 – 6.0 mm <sup>2</sup> (red · blue · yellow)		053440
<b>V2499-B</b>	Crimping socket B: for closed · non-insulated cable lugs of 1.5 · 2.5 · 6.0 · 10 mm <sup>2</sup>		053457
<b>V2499-C</b>	Crimping socket C: for open · non-insulated cable lugs of 0.5 – 6.0 mm <sup>2</sup> (width up to 6.3 mm)		053464
<b>V2499-D</b>	Crimping socket D: for wire end sleeves with or without collar from 0.5 – 4.0 mm <sup>2</sup>		053471
<b>V2499-F</b>	Crimping socket F: for wire end sleeves above 6.0 mm <sup>2</sup>		053488

**V2499-A**, EAN 4047728053440

## Crimping jaws



**V7548**, EAN 4047728075480

## Battery cell tester

- Check of the status of battery and charging systems (12 and 24 V)
- Suitable for start-stop batteries
- For passenger cars, motorcycles, vans and boats
- Functions:
  - Status report of the battery and charging systems
  - Debit note when starting up the motor
  - Identification of defective batteries
  - Option to print the test results
- Mobile use, without power supply
- Makes it possible to check when fitted or removed
- User-friendly operation
- Reverse polarity protection prevents short circuit
- Thermal paper castor included in delivery
- Clamping cable length: 600 mm
- CCA: 100 – 1700 Ah
- IEC: 100 – 1000 Ah
- EN: 100 – 1700 Ah
- DIN: 100 – 1000 Ah



**V7548-1**, EAN 4047728075527

## Thermal paper reel

- Width: 56 mm
- Linear length: 5 m
- Diameter: 29 mm
- Sleeve diameter: 15 mm



**V4326N**, EAN 4047728079860

## Measuring cable set

- Motor vehicle applications and 12 V batteries
- Measuring line adapters for simplifying fault diagnostics directly on the vehicle
- Polarity testers for testing hall sensor and photo sensors
- Measuring potentiometer for testing the temperature sensor and tank sensor
- Use with multimeter V4324
- 3 flat terminals, flat terminal sleeves, round terminals, pin-type cable connectors and pin-type cable sleeves





## Engine / cooling / air conditioning: keep your engine in top form

The reliability of a vehicle begins under the bonnet. Our selection of engine, cooling and air conditioning tools ensures you have everything you need to keep engines powerful but efficient. From engine testers and cooling system testing devices to air conditioning service tools – we offer you all the equipment you need for maintenance and repair.

Our products help you to optimise engine performance and efficiency, maintain cooling systems correctly and repair air conditioning systems effectively. They are designed to make work faster, more accurate and safer by allowing you to diagnose problems before they cause serious damage.

Rely on our smart tools to improve the service life and performance of every vehicle. Whether it's regular maintenance or specific repairs – with our support, your engine compartment will stay in top shape.

### Engine / Radiator / A/C

Engine tools	248–251
Cooling system diagnostics	251–253
Turbo system diagnostics	254–255
Compression and pressure loss testers	256
Injector sealing seat cleaning	257



STORAGE

**V5676**, EAN 4047728**056762**

## Lambda probe set

- Lambda probes, injection nozzles as well as thermal circuit-breakers in hard to reach areas

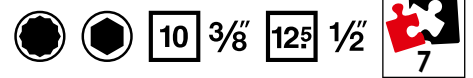

● 22 mm

□ 10 3/8



● 22 mm

□ 10 3/8



● 27 mm

□ 10 3/8



● 22 mm

□ 125 1/2



● 29 mm

□ 125 1/2



○ 27 mm

□ 125 1/2



● 22 mm

□ 10 3/8



**V7002/4**, EAN 4047728**079815**

## Spark plug socket set

- Ball joints allow easy installation and removal in hard-to-reach places, e.g. on motorcycles or BMW N43 and N53 engines
- Magnetic
- Slim design
- Sizes: SW 14 · 16 · 18 · 20.8 mm
- For manual operation

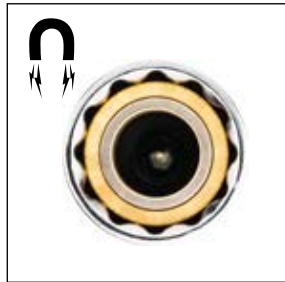
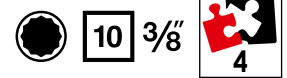

VIGOR No.	Designation	Design	■	●	Size	EAN 4047728+
V7002-14	Spark plug socket		10 3/8	●	14 mm	079822
V7002-16	Spark plug socket		10 3/8	●	16 mm	079839
V7002-18	Spark plug socket		10 3/8	●	18 mm	079846
V7002-20.8	Spark plug socket		10 3/8	●	20.8 mm	079853



**V6741**, EAN 4047728067416

## Extractor set for ignition coils

- Professional and damage-free removal of ignition coils and ignition coil strips on VAG and OPEL/VAUXHALL engines
- Attaching and then removing enables an even disassembly of the ignition module
- Recommended use in pairs
- Greatest market coverage
- 2 ignition module pullers for:
  - CHEVROLET/GMC Aveo Cruze · OPEL/VAUXHALL Adam · Agila B · Astra J · Cascada Combo · Corsa D · Meriva B · Mokka · Zafira Tourer
  - Engines:
    - 1 litre A10XEP (LDB), 1.2: A12XEL (LWD) A12XER (LDC), 1.4: A14XEL (L2Z) A14XER (LDD) LDU
    - 1.4 litres (T) A14NEL (LUH) A14NET (LUJ) Twinport / ecoFLEX engines
  - OPEL 3 or 4-cylinder petrol injection engines e.g. in Agila A · Astra F · Astra G · Astra H · Astra J · Calibra Combo · Corsa B · Corsa C · Corsa D · Frontera A · Frontera B · Insignia · Meriva A · Meriva B · Omega B · Signum · Tigra A · Tigra B · Vectra B · Vectra C · Zafira A · Zafira B
  - Engine codes: 20LEH · 2HO · A10XEP · A14NEL · A14NET · A14XER · A16LET · A16XER · A18XER · C22SEL · LDD · LDE · LLU · LUH · LUJ · X14NZ · X14SZ · X14XE · X16SZR · X16XE · X16XEL · X18XE · X20SE · X20XEV · X22SE · X22XE · Y22SE · Z10XEP · Z12XE · Z12XEP · Z14XE · Z14XEL · Z14XEP · Z16LEL · Z16LER · Z16LET · Z16XE · Z16XER · Z16YNG · Z18XE · Z18XER · Z20LER
- 4 ignition claws:
  - TYPE A (26 mm): e.g. VW Golf · Bora · Beetle · Lupo · Passat · Touran · T4 · AUDI A2
  - TYPE B (18 mm): Bora · Golf · Passat · Sharan · Touareg · Phaeton · T5
  - TYPE C (43 mm): 8 and 12-cylinder engines such as Phaeton, among others
  - TYPE D (35 mm): Direct injection engine VW Golf · Touran · Passat and Eos as well as AUDI A4 and A6



**V6740**, EAN 4047728077774

## Extractor set for ignition coils · VAG

- Safe and damage-free removal of ignition coils with final output stage according to manufacturer's specifications, e.g. on 1.0 l / 1.0 l TSI / TFSI / TGI / GTI / CNG - 1.0 l · 1.0 l TSI · TFSI · TGI · GTI · CNG · 1.2 l TSI · 1.4 l · 25 · 30 · 35 · 40 · 45 TSI · TFSI · TGI · CNG · GTE · Mild Hybrid · e-Hybrid · 1.6 l · 1.6 l SRE · MPI 2.0 l GTI
- Engines installed in the following models, among other: AUDI A1 · A3 · A4 · A5 · Q2 · Q3 SEAT Alhambra · Arona · Ateca · Cupra Formentor · Ibiza · León · Mii · Tarraco · Toledo ŠKODA Citigo · Fabia · Kamiq · Karoq · Kodiaq · Octavia · Rapid · Scala · Super · Yeti VW Arteon · Beetle · Caddy · Golf 6-8 · Jetta 4-7 · CC · Passat B8 · Polo 5-6 · Scirocco · Sharan · T7 · Taigo · Tiguan · Touran · T-Cross · T-Roc · Up!
- Removal of both ignition coil versions possible:
  - 04C.905.110.J model year 2017
  - 04E.905.110.K model year 2017→

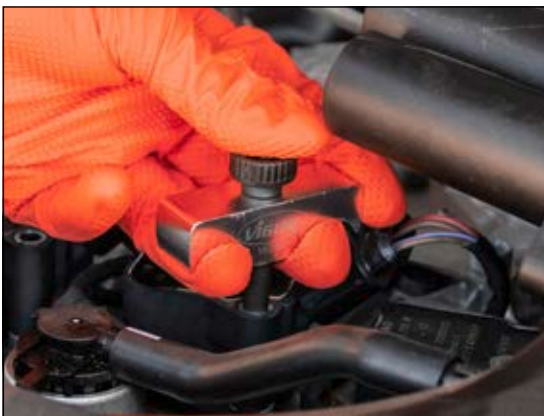

# Engine tools

## Cooling system diagnostics



**V3381**, EAN 4047728033817

### Hose clamp set

- For hoses with  $\varnothing$  up to 45 mm



**V3571**, EAN 4047728035712

### V-ribbed belt tool

- Fibre-glass reinforced nylon
- Most easy-to-use tool on the market
- No adjustment necessary
- For all flexible belts: air-conditioning systems, generators, and single/double pulleys

Installation



Removal



**V5660**, EAN 4047728056601

### Coupling element from 4.4 mm to 7.2 mm

- Adaptation of hand pump V3729 with products from other manufacturers, e.g. Klann adapters / systems (4.4 mm to 7.2 mm)



**V5922**, EAN 4047728059220

### Coupling element from 7.2 mm to 4.4 mm

- Adaptation of VIGOR cooling system adapter with e.g. Klann hand pumps / systems (7.2 mm to 4.4 mm)



**V2459N**, EAN 4047728075541

### Refractometer

- Fast, precise control of the anti-freeze concentration on coolant and screenwash as well as for checking the battery acid density and AdBlue
- Eyepiece with adjustable focus, equipped with rubber cup
- Left scale: battery acid density measuring range 1100 – 1400 sg / resolution 0.01 sg
- Middle scale: antifreeze based on propylene glycol G 13, measuring range 0°C to -50°C / resolution 5° C, and antifreeze based on ethylene glycol G 11/G 12, measuring range 0°C to -50°C / resolution 5° C
- Upper right scale: AdBlue (VRA) urea concentration, measuring range 30% – 35% / resolution 0.1%
- Lower right scale: screen wash antifreeze SRF 1, measuring range 10°C to -40°C / resolution 1°C
- Plastic box with soft foam insert
- Contents:
  - 1 x refractometer
  - 1 x pipette

Application e.g. for coolant, screenwash, battery fluid and AdBlue



**V1963/28**, EAN 4047728**081467**

## Cooling system diagnosis set

- Passenger car diagnostics
- New adapter series with approx. 20% space saving per adapter
- VIGOR cooling system lids have approx. 20% less height than comparable products on the market
- Comfortable and efficient work, by reaching almost all expansion tanks
- Greatest market coverage
- Including adapter no. 23 for common vehicle models such as AUDI A3 · A4 · VW Golf · Passat · Polo
- Complete set for service work on the cooling system and heating circuit
- Comprehensive range of adapters for vehicles with water-cooled engines
- 3 features: pressure test (check for leaks in radiator system) · filling · cleaning
- Control of pressure loss via manometer
- Filling creates a vacuum in the radiator system (Advantage: coolant is sucked in without air bubbles)
- Enables filling of even large engines without thermal influences
- Universal usage due to conical rubber radiator adapter
- Measuring range: 0–2.5 bar



VIGOR No.	Designation	Design	EAN 4047728+
V1963N-0	Cooling system diagnostics adapter · M52x4.0 AF		082075
V1963N-6	Cooling system diagnostics adapter · M52x2.5		082044
V1963N-8	Cooling system diagnostics adapter · M57.5x3.0		082051
V1963N-9	Cooling system diagnostics adapter · M61.7x3.0		082068
V1963N-A	Cooling system diagnostics adapter · M48x3.0		082082
V1963N-B	Cooling system diagnostics adapter · M52x3.0		082136
V1963N-C	Cooling system diagnostics adapter · M52x3.0		082099
V1963N-E	Cooling system diagnostics adapter · M45.5x2.5		082129
V1963N-F	Cooling system diagnostics adapter · M50x2.5		082112
V1963N-G	Cooling system diagnostics adapter · M52x2.5		082167
V1963N-H	Cooling system diagnostics adapter · M32x2.0		082181
V1963N-M	Cooling system diagnostics adapter · M63x4.0 AA		082105



**Largest model coverage  
on the market!**  
**Compatible with hybrid vehicles**

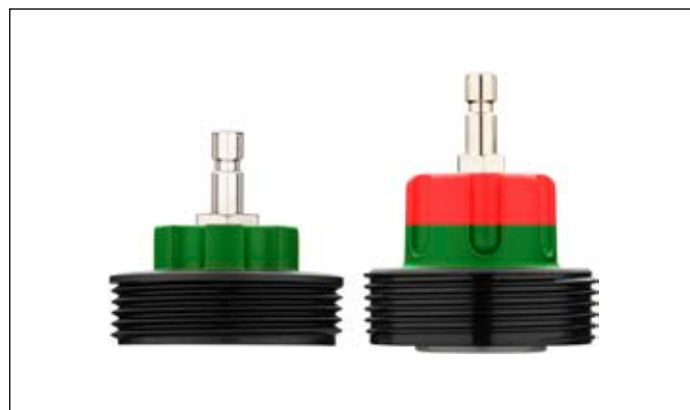

VIGOR No.	Designation	Design	EAN 4047728+
V1963N-R	Cooling system diagnostics adapter · M45 x 3.0		082174
V1963N-S	Cooling system diagnostics adapter · M48.5 x 3.0 FA		082143
V1963N-T	Cooling system diagnostics adapter · M33.6 x 3.0 AF		082150
V1963N-X	Cooling system diagnostics adapter · M55 x 2.5		082198
V1963-3	Test adapter black R123 · R124		053242
V1963-4	Test adapter blue R123 · R125		053259
V1963-5	Bayonet adapter · Ø 38 mm		053266
V1963-6	Bayonet adapter · Ø 42 mm		053273
V1963-7	Bayonet adapter · Ø 50 mm		053280
V3729	Hand pump with manometer		037297
V4202	Vacuum filling unit		042024
V1963-25	Universal adapter / cone		060127



**V4192**, EAN 4047728**041928**

## Turbo system pressure tester set for click systems

- Quick diagnosis of charging air systems in new generations of vehicles in which air pipes are connected with click systems
- Performing leak tests using noise generation, leak detector spray or pressure drop
- Contents:  
6 plug pairs 31 · 38 · 46 · 51 · 56 · 61 mm



Without manometer

*Enables time saving and appropriate determination of leaking charging air hoses*



**V4233**, EAN 4047728**042338**

## Manometer for turbo system pressure tester set

For V3595 · V4192 and V4331





**V4304**, EAN 4047728**043045**

**Turbo system pressure tester set for motor vehicles**

- Fast diagnostics of the charging air system
- Proper, time-saving identification of leaky charge-air coolers and invisible cracks in charging air hoses
- Contents:
  - 1 pressure hose with manometer and equalising valve
  - 6 pairs of graduated adapters: 31/38 · 46/51 · 55/60 · 65/70 · 75/80 · 85/90 mm



Including manometer



**V4305**, EAN 4047728**043052**

**Adapter 31/38 mm**

- Use with manometer V4233 for testing the turbo system
- For example as an extension to the turbo system pressure tester set V3595



**V4306**, EAN 4047728**043069**

**Adapter 46/51 mm**

- Use with manometer V4233 for testing the turbo system
- For example as an extension to the turbo system pressure tester set V3595



**V4461**, EAN 4047728**044615**

## Compression and pressure loss tester set

- Professional testing of compression and pressure loss for the engines of most of passenger cars, trucks, motorcycles, buses, agricultural vehicles and boats as well as Hdi, TDCi and pump injector engines
- For diesel and petrol engines
- Contains glow plug adapter for e.g.: ALFA ROMEO · BMW · CHRYSLER · DAEWOO · FIAT · FORD · HYUNDAI · ISUZU · LAND ROVER · MAZDA · MERCEDES-BENZ · MITSUBISHI · NISSAN · OPEL · PSA · RENAULT · SAAB · SUZUKI · TOYOTA · VAG · VAUXHALL · Volvo · etc.
- Glow plug adapter M10 · M12 · M14 · M18
- Compression pressure gauge maximum 50 bar
- Quick coupler in straight and angled design
- Injector nozzle adapter M20 · M22 · M24 and for FORD Stanadyne injectors



*For diesel and petrol engines*

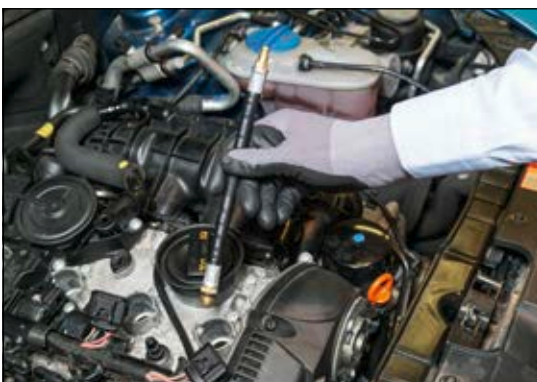

# Injector sealing seat cleaning



**V4941N**, EAN 4047728077293

## Injector sealing seat cleaning set

- Eliminating soot residues, particles on HDI, diesel direct injection and common rail engines with Bosch and Delphi injectors
- Including sealing plug for protection against combustion chamber contamination
- Centring crowns for accurate guiding



*Proper cleaning of the injector sealing seat, injector tip and pintle opening*

VIGOR No.	Designation	Design	← L → mm	EAN 4047728+
V4941N-1	Sealing ring spreader		265	077415
V4941N-2	Reamer		225	077422
V4941N-3	Cutter head holder · long · knurled handle		255	077439
V4941N-4	Adapter · flexible		225	077446
V4941N-5	Cutter head holder · short		175	077453
V4941N-M5	Protection cap · M5		15	077460
V4941N-BL	Cleaning brush · long		300	077576
V4941N-BK	Cleaning brush · short		85	077569
V4941N-19T	Hexagon · T handle · 19 mm		155	077521
V4941N-10	Holder for protection cap · M5		200	077477
V4941N-11	Holder for cleaning brush		90	077514
V4941N-245	Adapter · Ø 24.5 mm		32.8	077552
V4941N-20	Adapter · Ø 20 mm		32	077538
V4941N-22	Adapter · Ø 22 mm		32.8	077545

VIGOR No.	Designation	Design	← L → mm	EAN 4047728+
V4941N-R1	Cutter · 120 degrees · 15.5x15.5 mm		38	077583
V4941N-R2	Cutter · 90 degrees · 15.5x15.5 mm		38	077590
V4941N-R3	Cutter · 90 degrees · 14x14 mm		38	077606
V4941N-R4	Cutter · 90 degrees · 19x21.5 mm hexagon		38	077613
V4941N-R5	Cutter · 120 degrees · 17x21 mm		38	077620
V4941N-R6	Cutter · 90 degrees · 17x20 mm		38	077637
V4941N-R7	Cutter · 120 degrees · 17.5x20.5 mm		38	077644
V4941N-R8	Cutter · 90 degrees · 17x19.5 mm		38	077651
V4941N-R9	Cutter · 90 degrees · 17x19 mm		38	077668
V4941N-R10	Cutter · 90 degrees · 15x19 mm		38	077675
V4941N-R11	Cutter · 90 degrees · 17x17.5 mm		38	077682
V4941N-R12	Cutter · 120 degrees · 17x17 mm		38	077699
V4941N-R13	Cutter · 90 degrees · 17x17 mm		38	077705

## Oil service: for a smooth ride

Regular maintenance of the oil system is crucial for the longevity and efficiency of any vehicle. Our range of oil service products includes everything you need for oil changes and system maintenance – from oil filter pliers to professional oil collection trays.

Our high-quality tools and equipment make oil changes quick, clean and efficient. They help you to carry out the work with precision – while reducing operating costs because the vehicle always runs optimally.

Whether it's a small garage or a large workshop, our oil service products are a reliable choice for professionals who value quality.



## Oil service

Oil dipsticks

259

Oil filter tensioner adjusters

260

Oil pumps and filling devices

261–263

**V5048**, EAN 4047728050487

## Tank sensor key · universal

- Operation of lock ring on tank sensor
- For areas with restricted access

*Proper and time-saving working without damaging the lock ring*

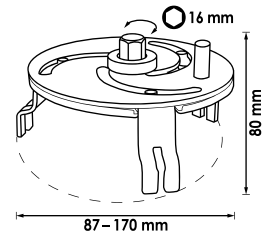

**V2645**, EAN 4047728026451

## Oil dipstick AUDI

- Check the level after oil change and subsequent comparison with the display
- For models with oil level indicator on the display (no dipstick in the engine)
- Helpful after replacing the oil sensor or calibrating the indicator in the driver's display (comparable to T40178)
- Application: for AUDI A4 / A5 / A6 with engines 1.8 · 2.0 TFSI / 3.0 · 3.2 FSI / 2.0 · 2.7 · 3.0 TDI, among others

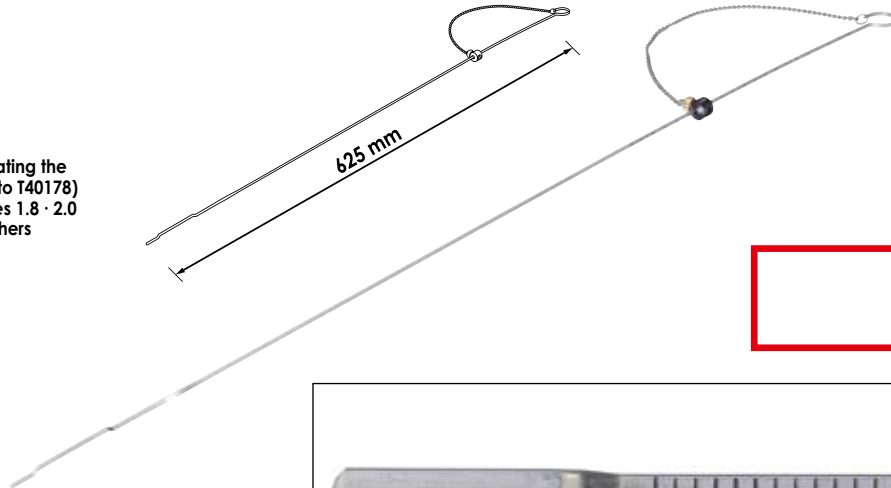

**V2511N**, EAN 4047728068239

## Oil filter strap wrench

- Installation and removal of oil filters
- Continuously adjustable
- Setting to filter diameter by turning on the end of the handle
- Ergonomic handle

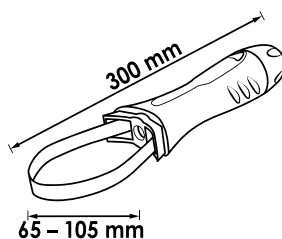

**V2521**, EAN 4047728025218

## Spare strap

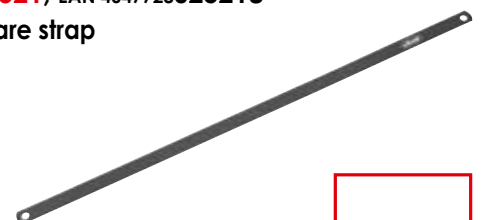

## V1281, EAN 4047728012812

### Oil filter claw wrench

- Optional drive:  $\square \frac{1}{2}$  inside square or size 21 mm  $\bullet$  outside hexagon

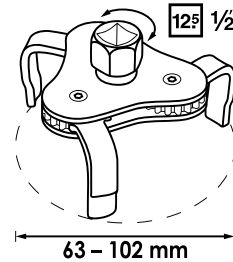
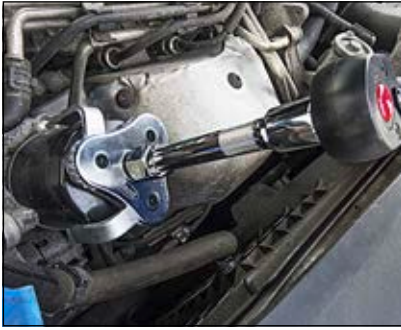

## V7385, EAN 4047728077194

### Gearbox tool set · MERCEDES-BENZ · 9-speed Tronic

- Draining and filling the gearbox oil on 9-speed Tronic automatic transmission with identification 725 (725589029000 · 725589009000)
- All necessary tools for oil change
- Drain wrench for adjusting the standpipe
- Contents:
  - Oil filter adapter (use with oil filling device V4385N)
  - Multifunction oil drain wrench
  - Oil drain wrench



### Oil filter tensioner adjuster · universal

- Mechanical locking of the oil filter wrench simplifies subsequent attachment of the reversible ratchet to the oil filter wrench
- The oil filter tensioner adjuster always remains under tension when the reversible ratchet is moved backwards
- Infinitely adjustable
- Use with wrench size 21 mm or  $\square \frac{1}{2}$  reversible ratchet
- Optimal hold when loosening the oil filter thanks to left-toothed jaws
- For oil filters in areas with restricted access
- Clockwise/anti-clockwise application enables operation of the screw connection

Size 21 mm

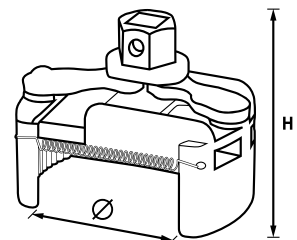

#### Continuous serration



VIGOR No.	Height	■	∅ mm	EAN 4047728+
V4413	60	● 21 mm, $\square \frac{1}{2}$	60-80	044134
V4414	70	● 22 mm, $\square \frac{1}{2}$	80-115	044141
V4415	105	● 24 mm, $\square \frac{1}{2}$	115-140	062114

**V4701**, EAN 4047728073844

## Mini vacuum pump

- Manual vacuum pump for extracting and filling vehicle fluids
- Fill level display is nice and clear
- Accurate dosage and easy handling thanks to ergonomic design
- Capacity: 100 ml
- Including rubber tubing with stop cap to prevent leakage
- For the following liquids:
  - Diesel fuels
  - Petrol
  - Brake fluid
  - Antifreeze
  - Engine oil
  - Transmission oil
  - Power steering oil

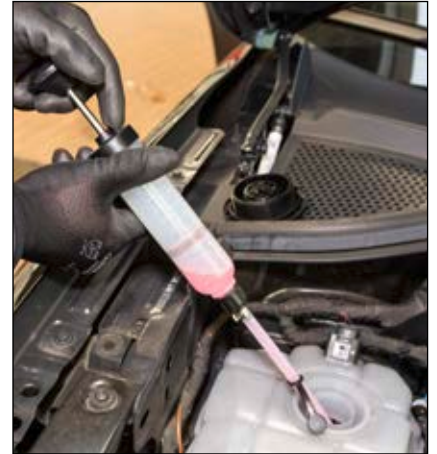
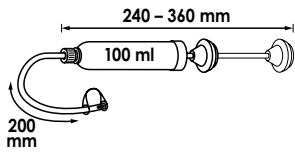

**V4369**, EAN 4047728043694

## Vacuum pump

- Suction intake and decanting of fuels, oils and other liquids
- Capacity: 350 ml
- For the following liquids among others:
  - Diesel fuels
  - Petrol
  - Brake fluid
  - Antifreeze
  - Engine oil
  - Transmission oil
  - Power steering oil
- Contents:
  - 1 x hand pump 350 ml
  - 1 x PVC hose  $\varnothing$  9.8 x 300 mm
  - 1 x silicone hose  $\varnothing$  11 x 300 mm
  - 1 x drip plug
  - 1 x universal adapter

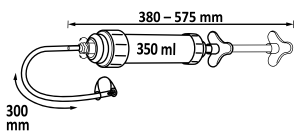

**V4201**, EAN 4047728042017

## Vacuum pump

- Manual vacuum pump for extracting and filling vehicle fluids
- Pre-filling the fuel filter in vehicles without a pre-filter pump, e.g. the 2.0 l TDI FORD Galaxy and Mondeo
- Capacity: 1.5 l
- For the following liquids:
  - Diesel fuels
  - Petrol
  - Brake fluid
  - Antifreeze
  - Engine oil
  - Transmission oil
  - Power steering oil
- Adapters included:
  - Inside 3/8" (10 mm) to outside 3/8" (10 mm)
  - Inside 5/16" (8 mm) to outside 3/8" (10 mm)
  - Outside 3/8" (10 mm) to outside 3/8" (10 mm)
  - Outside 5/16" (8 mm) to outside 3/8" (10 mm)
  - Outside variable to outside 3/8" (10 mm)

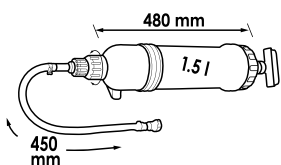

Suitable for all fuel types



**V4201-1**, EAN 4047728056588  
Gasket set for V4201



**V4385N**, EAN 4047728072601

## Oil filling device with adapter set

- Filling gearboxes and differentials with oil
- Incl. oil pan and 16 adapters for vehicles with limited installation space
- Filling hose 1.5 m

*New improved set content*



VIGOR No.	Designation	Design	EAN 4047728+
V3681	Adapter FORD · with threaded connection		036818
V3682	Adapter BMW · bent		036825
V3683	Adapter VAG · short · bent		036832
V3684	Adapter VAG · long · bent		036849
V3685	Adapter VAG · straight · with threaded connection		036856
V3686	Adapter MERCEDES-BENZ · 7-speed automatic		036863
V3687	Adapter VAG · DSG direct shift gearbox		036870
V3688	Adapter VAG CVT · continuously variable transmission		036887
V3689	Adapter Volvo · straight		036894
V3690	Adapter ŠKODA · M18x1.5 mm		036900
V3691	Adapter VW · Passat		036917
V4113	Adapter TOYOTA · LEXUS · 18x1.5		041133
V4114	Adapter Infiniti · 7 speed M8x1.0		041140
V4115	Multifunction adapter		041157
V4383	Adapter NISSAN · Juke M12x1.25 mm		043830
V4384	Adapter MINI Cooper · M14x1.5 mm		043847
V7285	Adapter NISSAN · Hybrid · M10x1.5		072854
V7286	Adapter GM · M12x1.75		072861
V7287	Adapter ŠKODA · M18x1.5		072878
V7288	Adapter VAG · 7-speed dual clutch		072885





**V6027N**, EAN 4047728**084505**

## Oil filler tank set

- For all common vehicle models
- Quick and uncomplicated filling of oil
- Prevents oil from spilling
- Reduces oil stains and dirt contamination in the engine compartment



**NEW**



For all common  
vehicle models



## Brakes: safety through precision

Safety comes first – and this is especially true for a vehicle's brakes. Our selection of specialty tools for brakes and equipment helps you to maintain and repair brake systems. From simple brake lining changes to complex brake system repairs – we offer everything you need for safe and effective work.

Our products include solutions for all aspects of brake maintenance – including specialised tools for brake cylinders, brake lines and anti-lock braking systems (ABS). With our precision tools, you can ensure that every component functions correctly and offers maximum safety.

Whether you're working on passenger cars or commercial vehicles, our specialty tools for brakes will help you to carry out your work with accuracy. Rely on our expertise to optimise the braking performance of any vehicle – while ensuring road safety at the same time.

## Brakes

**Brake maintenance and bleeding**

**265–267**

**Brake piston readjusting tools**

**268–271**

**Brake disc tools**

**272–273**

**Tube flaring tools**

**274–276**

**Inspection tools**

**277–279**

**V4411**, EAN 4047728**044110**

## Brake bleeder set 3 l · manual

- Bleeding brake and coupling systems
- Working pressure: max. 1.4 bar
- Manometer range: 0 – 2 bar
- Draining of the pressure through integrated pressure relief valve
- Contents:
  - 3 litre tank
  - E20 Euro adapter
  - Universal adapter with chain
  - Connecting hose with quick connection
  - Collection tank with connection nipple for brake systems

*Especially suited for mobile use with manual pressure build-up function*



Capacity: 3 litres



**V4668**, EAN 4047728**046688**

## Brake fluid tank

- Collection tank for bleeding brake and coupling systems
- Silicone tube, length: 550 mm
- Contents of V4411

*Suitable for all common bleeding valves*



Capacity: 0.7 litres



**V7471**, EAN 4047728**074711**

## Brake bleeding set

- Bleeding brake line systems, changing brake fluids without removing the wheels  
Also for bleeding coupling systems
- Comfortable application thanks to ergonomic special ratchet
- Easy opening and closing of the brake nipple thanks to special hinge ratchet
- Guarantees fast access to the brake nipple even with the wheel mounted
- Good power transmission due to application-optimised handle
- Angle coupling piece in 90° design with back pressure valve and anti-rotation protection
- Back pressure valve protects system against ingress of air



### Optional accessories (not included in delivery)

VIGOR No.	Designation	Design	Size	EAN 4047728+
V7471-A	90° Universal adapter		-	074889
V7471-T	Silicon hose		-	074896
V7471-TL	Rubber hose · long		-	074865
V7471-TS	Rubber hose · short		-	074858
V7471-W	Brake bleeding 14 mm hexagon		-	074872
V7471L-10	Socket set · long · 10 mm		10 mm	074834
V7471L-11	Socket set · long · 11 mm		11 mm	074827
V7471S-10	Socket · short · 10 mm		10 mm	074759
V7471S-11	Socket · short · 11 mm		11 mm	074766

VIGOR No.	Designation	Design	Size	EAN 4047728+
V7471S-7	Socket · short · 7 mm		7 mm	074728
V7471S-8	Socket · short · 8 mm		8 mm	074735
V7471S-9	Socket · short · 9 mm		9 mm	074742
V7471S-12	Socket · short · 12 mm		12 mm	074773
V7471L-7	Socket set · long · 7 mm		7 mm	074780
V7471L-8	Socket set · long · 8 mm		8 mm	074797
V7471L-9	Socket set · long · 9 mm		9 mm	074803
V7471L-12	Socket set · long · 12 mm		12 mm	074841

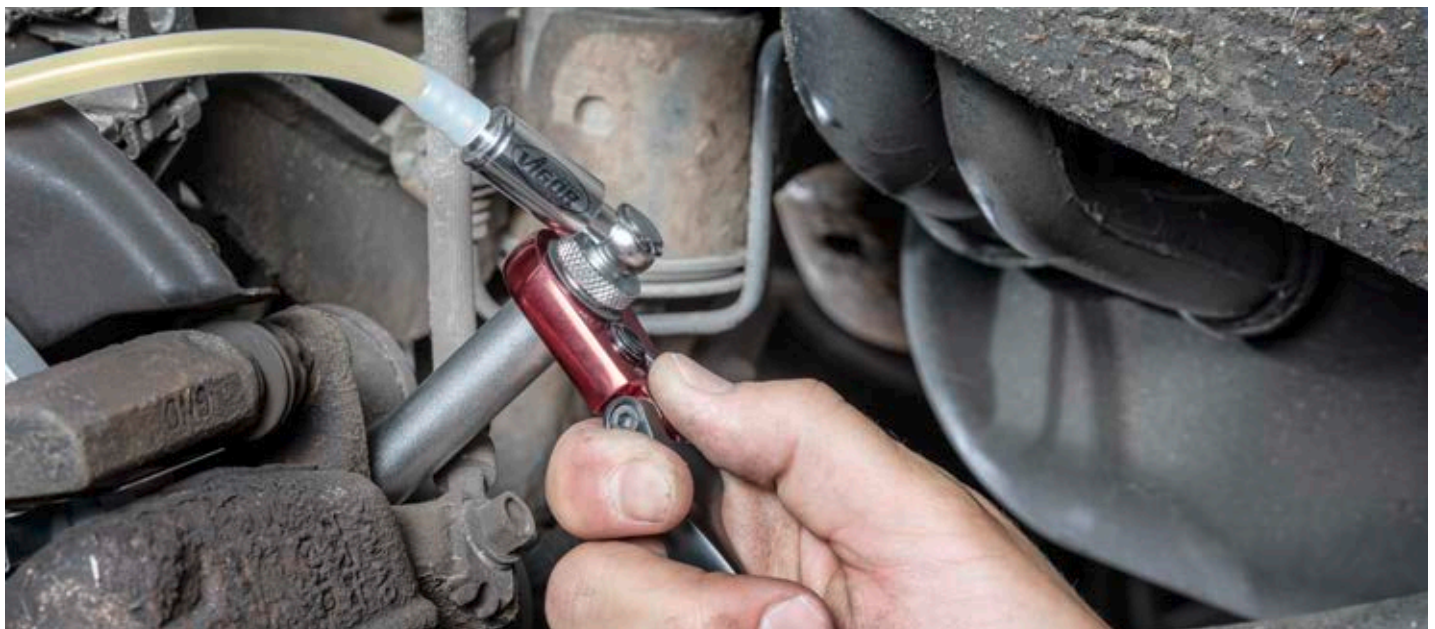

**V7471/17**, EAN 4047728077187

## Complete brake bleeding set

- Bleeding brake line systems, changing brake fluids without removing the wheels  
Also for bleeding coupling systems
- Comfortable application thanks to ergonomic special ratchet
- Easy opening and closing of the brake nipple thanks to special hinge ratchet
- Guarantees fast access to the brake nipple even with the wheel mounted
- Good power transmission due to application-optimised handle
- Angle coupling piece in 90° design with back pressure valve and anti-rotation protection
- Back pressure valve protects system against ingress of air
- Nut-driver: size 7 – 12 mm in short and long designs included in delivery



7 – 12 mm



VIGOR No.	Designation	Design	Size	EAN 4047728+
V7471-A	90° Universal adapter		-	074889
V7471-T	Silicon hose		-	074896
V7471-TL	Rubber hose · long		-	074865
V7471-TS	Rubber hose · short		-	074858
V7471-W	Brake bleeding ratchet 14 mm hexagon		-	074872
V7471L-7	Socket set · long · 7 mm		7 mm	074780
V7471L-8	Socket set · long · 8 mm		8 mm	074797
V7471L-9	Socket set · long · 9 mm		9 mm	074803
V7471L-10	Socket set · long · 10 mm		10 mm	074834
V7471L-11	Socket set · long · 11 mm		11 mm	074827
V7471L-12	Socket set · long · 12 mm		12 mm	074841
V7471S-7	Socket · short · 7 mm		7 mm	074728
V7471S-8	Socket · short · 8 mm		8 mm	074735
V7471S-9	Socket · short · 9 mm		9 mm	074742
V7471S-10	Socket · short · 10 mm		10 mm	074759
V7471S-11	Socket · short · 11 mm		11 mm	074766
V7471S-12	Socket · short · 12 mm		12 mm	074773

VIGOR No.	Designation	Design	Size	EAN 4047728+
V7471S-7	Socket · short · 7 mm		7 mm	074728
V7471S-8	Socket · short · 8 mm		8 mm	074735
V7471S-9	Socket · short · 9 mm		9 mm	074742
V7471S-12	Socket · short · 12 mm		12 mm	074773
V7471L-7	Socket set · long · 7 mm		7 mm	074780
V7471L-8	Socket set · long · 8 mm		8 mm	074797
V7471L-9	Socket set · long · 9 mm		9 mm	074803
V7471L-12	Socket set · long · 12 mm		12 mm	074841

## V3760N, EAN 4047728066310

### Brake piston readjusting tool set

- Clockwise and anti-clockwise brake pistons
- Including 4 special sockets
- Reset by pressing and simultaneously turning the brake piston
- Numbering of the adapter plates for detailed assignment
- Magnetic spindle sockets for comfortable work
- Contents:
  - 2 spindles (anti-clockwise and clockwise)
  - 2 hex-head wrenches (6 and 7 mm)
  - 2 drift pins
  - 3 exchangeable reaction plates
  - 36 reaction plates and adapters
  - 4 special brake fitting sockets
  - 1 spindle grease
- Adapters enable use even on very worn brake linings and assembly of the back plate in the break calliper



VIGOR No.	Designation	Design	■	∅	Pin diameter	Pin height	Size	← L → mm	EAN 4047728+
V3760-1	Adapter plate 1		-	-	-	-	-	-	067164
V3760-2	Adapter plate 2		-	51	6	9	-	-	066853
V3760-3	Adapter plate 3		-	55	-	-	-	-	067201
V3760-4	Adapter plate 4		-	32	5	2.5	-	-	066631
V3760-5	Adapter plate 5		-	36	6	4	-	-	066648
V3760-6	Adapter plate 6		-	42	6	4	-	-	066655
V3760-7	Adapter plate 7		-	42	6	2	-	-	066662
V3760-11	Adapter plate 11		-	-	-	-	-	-	066679
V3760-12	Adapter plate 12		-	-	-	-	-	-	066686
V3760-A	Adapter plate A		-	41	6	4	-	-	066693
V3760-B	Adapter plate B		-	38	10	3	-	-	066709
V3760-C	Adapter plate C		-	38	4	3	-	-	066716
V3760-D	Adapter plate D		-	51	6	3	-	-	066723
V3760-E	Adapter plate E		-	42	5	3	-	-	066730
V3760-F	Adapter plate F		-	36	6	4	-	-	066747
V3760-G	Adapter plate G		-	32	4	3	-	-	066754
V3760-J	Adapter plate J		-	44	6	3	-	-	066761

# Brake piston readjusting tools



VIGOR No.	Designation	Design	■	∅	Pin diameter	Pin height	Size	mm	EAN 4047728+
V3760-K1	Adapter plate K1		-	54	10	7	-	-	066778
V3760-K2	Adapter plate K2		-	45	6	4	-	-	066785
V3760-M	Adapter plate M		-	32	6	3	-	-	066792
V3760-P	Adapter plate P		-	38	4	4.5	-	-	066808
V3760-Q	Adapter plate Q		-	32	5.5	3	-	-	066815
V3760-R	Adapter plate R		-	36	6	4	-	-	066822
V3760-S	Adapter plate S		-	38	4	3	-	-	066839
V3760-T	Adapter plate T		-	28	5	4	-	-	066952
V3760-V	Adapter plate V		-	40	4	2.5	-	-	066969
V3760-X	Adapter plate X		-	-	-	-	-	-	066976
V3760-Z	Adapter plate Z		-	30	4	4.5	-	-	066983
V3760-8	Adapter plate 8		-	48	5.5	3	-	-	066990
V3760-9	Adapter plate 9		-	54	5.5	3	-	-	067003
V3760-0	Adapter plate 0		-	63.5	5.5	3	-	-	067010
V3760-0-DISC	Adapter plate 0-DISC		-	59	-	-	-	-	067027
V3760-K	Adapter plate K		-	54	8	4	-	-	067034
V3760-N	Adapter plate N		-	32	12	5	-	-	067041
V3760-IV	Adapter plate IV		-	42	6	9	-	-	067058
V3760-H6	Offset screwdriver H6		-	-	-	-	-	-	067065
V3760-H7	Offset screwdriver H7		-	-	-	-	-	-	067072
V3760-A1	Adapter plate A1		-	40	5.5	4	-	-	067089
V3760-B1	Adapter plate B1		-	45	6	5	-	-	067096
V3760-F1	Adapter plate F1		-	44	4	3.5	-	-	067102
V3760-P1	Adapter plate P1		-	37	6	3.5	-	-	067119
V3760-G1	Pressure plate G1		-	42	5	5	-	-	067133
V6632	Socket		$10 \frac{3}{8}$	-	-	-	9 mm	31	066327
V6633	Socket		$12 \frac{1}{2}$	-	-	-	22 mm	48	066334
V6634	Socket		$12 \frac{1}{2}$	-	-	-	20 mm	38	066341
V6635	Socket		$12 \frac{1}{2}$	-	-	-	11.5 mm	50	066358

**V3760-VW**, EAN 4047728**071666**  
**Adapter VW**



**V1711N**, EAN 4047728**060738**

**Brake piston readjusting tool set · pneumatic**

- Pushing and turning of brake pistons on nearly all passenger cars
- Efficient, damage-free working on brake systems
- For clockwise and anti-clockwise brake pistons
- Makes controlled rewinding by hand possible, in addition to pneumatic support
- Quick-connectors allow adapters to be mounted easily
- Automatic balancing of different thread pitches
- Set with 23 pieces: 1 pneumatic spindle · 22 adapter plates



Now even greater market coverage



**V1711-1**, EAN 4047728**067331**

**Brake piston readjusting tool · pneumatic**

- For right- and left-hand threads
- Protects against damage to sleeve gaskets
- Makes simultaneous operation and turning possible
- Magnet on the socket ensures the adapter is secure





**V7132N**, EAN 4047728**076500**

## Brake piston readjusting tool set · hydraulic

- For multiple piston brake systems  
Uniform resetting of the brake piston, without damage to piston and sealing
- Replaceable press jaws for clamping range 30 – 70 mm
- Press jaws 360° adjustable – optimal adjustment
- Ideal for floating and fixed callipers
- Adjustable to a large range of brake calliper shapes and numbers of pistons
- Pressure plates: 2x L 90 x B 2 mm · 2x L 90 x B 4 mm · 2x L 150 x B 4 mm
- Maximum power transmission: 2 t



**V7158**, EAN 4047728**071581**

**Brake calliper screw connection set**

- Brake calliper screw connection on e.g. VW · AUDI · PORSCHE · MERCEDES-BENZ · BMW · FORD · MAZDA · Volvo
- Including all common profile sizes for removal / installation of the brake calliper
- Special profiles for loosening the screw connections of separated brake callipers
- Ideal for floating and fixed brake callipers



VIGOR No.	Designation	Design	■		Size	mm	EAN 4047728+
V6633	Socket		12 <sup>29</sup> 1/2	-	22 mm	48	066334
V6634	Socket		12 <sup>29</sup> 1/2	-	20 mm	38	066341
V6635	Socket		12 <sup>29</sup> 1/2	-	11.5 mm	50	066358
V6636	Socket		12 <sup>29</sup> 1/2	-	14 mm	50	071406
V7158-1	Socket		10 3/8	●	7 mm	24	071598
V7158-2	Socket		10 3/8	●	8 mm	24	071604
V7158-3	Socket		6.3 1/4	●	9 mm	20	071611
V7158-4	Socket		10 3/8	○	9 mm	50	071628
V7158-5	Socket		10 3/8	○	7 mm	65	071635
V7158-6	Socket		10 3/8	○	7 mm	92	071642
V7158-7	Socket		10 3/8	○	11 mm	100	071659
V7158-8	Socket		10 3/8	○	8 mm	30	071888

**V6632**, EAN 4047728**066327**

**Socket**

- Brake calliper screw connection on e.g. VW · AUDI · PORSCHE · MERCEDES-BENZ · BMW · FORD · MAZDA · Volvo



**V4930**, EAN 4047728049306

## Calliper gauge for brake discs

- Fast, effective determination of the brake disc diameter without removing the wheel first
- Time saving through clear identification of the installed brake system (advantage: fewer incorrect orders)
- Universal clamping range: 200–400 mm

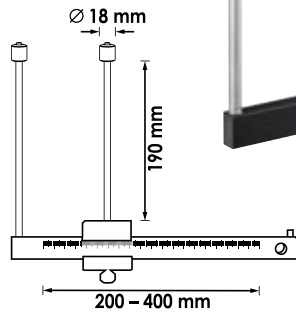

Performing the measurement without wheel removal



**V4399**, EAN 4047728043991

## Brake disc thickness gauge

- Fast, efficient test for determining the current brake disc thickness
- Note: see the manual of the vehicle manufacturer for the minimum wear limits of the brake discs

Display range 0 – 45 mm

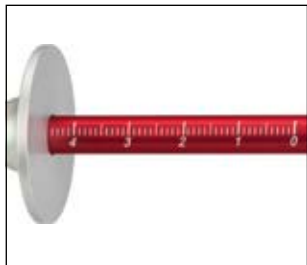

Performing the measurement without wheel removal



**V7401**, EAN 4047728074018

## Brake disc thickness gauge · digital

- Measuring minimum thickness of brake discs
- Performing the measurement without wheel removal
- Digital LCD display
- Stainless steel design
- Note: note the minimum wear limits of the brake discs from the vehicle manufacturer manual
- Including 3 volt battery CR2032
- Measuring range of 0 – 80 mm



## V4416, EAN 4047728044165

### Tube flaring tool for Ø 4.75 mm

- Exclusively for DIN flaring
- Lightweight and easy to handle
- Exact positioning of the brake line in the device using a spacing adapter
- Application on brake and hydraulic lines directly on the vehicle
- For thin-walled pipes made of steel, aluminium and copper (metric / inch)
- No damage to coated lines
- For DIN "F" flares 180°



For DIN "F" flares



Particularly suited for direct use on the vehicle

VIGOR No.	Designation	Design	EAN 4047728+
V4416-1	DIN flaring screw 4.75 mm		049313
V4416-2	Screw sleeve		049337
V4416-3	Spacing screw		049344
V4416-4	Bolt		049351
V4416-5	Handle		049375

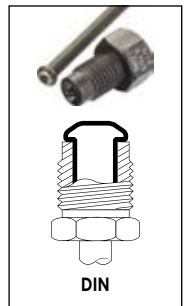

## V4697, EAN 4047728046978

### Tube flaring tool for Ø 4.75 mm

- Flared tube ends of Ø 4.75 mm lines according to DIN and SAE standards
- Extremely small construction ensures that it is possible to work in confined spaces
- No damage to coated lines
- Distance adapter prevents incorrect positioning of the brake line
- For steel, aluminium and copper lines
- For 180° DIN "F" flares, as well as SAE "F" double flares
- Contents:
  - 1 basic unit
  - 1 DIN flare adapter
  - 1 SAE flare adapter
  - 1 distance adapter
  - 1 special grease



For DIN · SAE and F flares



Particularly suited for direct application on the vehicle due to easy handling

VIGOR No.	Designation	Design	EAN 4047728+
V4416-1	DIN flaring screw 4.75 mm		049313
V4416-2	Screw sleeve		049337
V4416-3	Spacing screw		049344
V4416-4	Bolt		049351
V4697-1	Flaring screw (SAE) · 4.75 mm		049320
V4697-2	Handle		049368

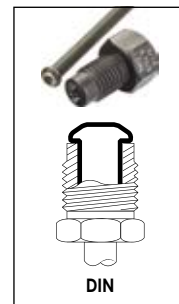

# Tube flaring tools



**V1728**, EAN 4047728**017282**

## Tube flaring tool set

- Direct application on brake and hydraulic lines on vehicles
- For thin-walled pipes made of steel, aluminium and copper (metric / inch)
- Producing convex and double flares (DIN/SAE standards)
- No damage to coated lines
- For 180° DIN "F" flares and SAE "F" double flares, as well as simple "D" flares



For DIN · SAE flares



VIGOR No.	Designation	Design	EAN 4047728+
V2466	Quick-change holder		024662
V2559	Basic unit		025591
V2467	Hydraulic spindle		024679
V2558	Thrust block 90° DIN / SAE		025584
V2553	Thrust block DIN/SAE		025539
V2554	Thrust block DIN/SAE		025546
V2556	Thrust block DIN/SAE		025560
V2555	Thrust block DIN/SAE		025553
V2626	Tube cutter		026260
V2551	Set of gripping jaws 5 mm		025515
V2552	Set of gripping jaws 6 mm		025522
V2540	Set of gripping jaws 4.75 mm		025409
V1782	Tube bending tool		017824
V4697-2	Handle		049368



**V5513**, EAN 4047728055130

## Tube flaring tool set

- Flaring steel, aluminium or copper brake lines with  $\varnothing$  4.75 · 5 · 5.15 · 5.25 · 6 mm
- Modern BMW and VAG brake lines are covered with an additional plastic layer ( $\varnothing$  5.15 / 5.25 mm)
- Flaring is not possible with standard tube flaring tools
- Exclusively for DIN flaring
- Direct application on brake and hydraulic lines on vehicles

*For new VAG and BMW brake lines with additional covering*

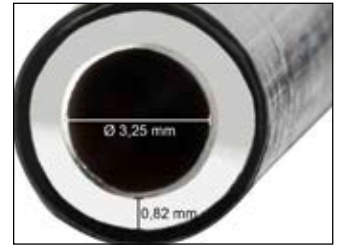
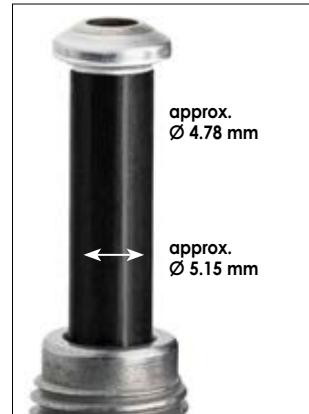

New brake line



Positioning of line to scrape the covering



Mounting the union nut



Positioning the line



DIN flaring process



VIGOR No.	Designation	Design	EAN 4047728+
V5513-1	DIN flaring screw 6 mm		055147
V5513-2	Line cutter 3 - 16 mm		055154
V5513-3	Line scraper 3 - 16 mm		055161
V4416-1	DIN flaring screw 4.75 mm		049313
V4416-2	Screw sleeve		049337
V4416-3	Spacing screw		049344
V4416-4	Bolt		049351
V4697-2	Handle		049368
V1782	Tube bending tool		017824



**V2789N**, EAN 4047728062824

## Brake and fuel line inspection tool

- Detection of hidden corrosion during general inspection
- 12 cleaning edges for removal of dirt and rust from various lines
- $\varnothing$  3.5 mm · 4.0 mm · 4.75 mm

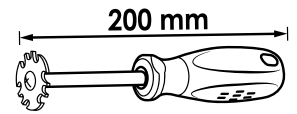

**V5691**, EAN 4047728056915

## Brake calliper file

- For removing brake dust, rust and dirt from the brake calliper without damaging the brake sleeves
- Extremely narrow design allows high flexibility
- All four sides of the square are toothed with 2 different thicknesses (cut)
- Width square: 9 mm

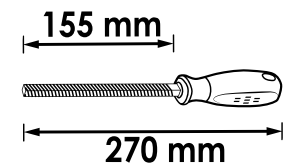

**V5909**, EAN 4047728059091

## Brake hook

- For hanging up the brake calliper during work on brakes (prevents damage to the brake hose)
- Also suitable for hanging up hoses or cables
- Surface: dip-insulated



**V2250**, EAN 4047728022507

## Brake calliper brush · steel

- Removal of stubborn brake dust
- Very slim design



With hanging hole

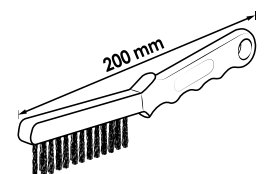

**V2249**, EAN 4047728022491

## Brake calliper brush · brass

- Cleaning aluminium brake callipers
- Removal of stubborn brake dust
- Allows access into small brake callipers



With hanging hole

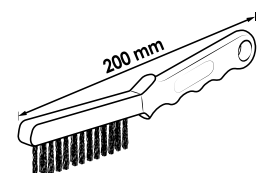

**V6917**, EAN 4047728069175

## Brake line ratcheting tube cutter

- Space saving, with ratchet mechanism. For 4.75 mm brake lines
- Ratcheting mechanism in the head of the tool minimises space required – can be used directly on the vehicle
- No readjustment of the cutting wheel due to self-adjustment
- Faster cutting result than conventional line cutters
- Adjustment of the self-adjusting cutting force possible
- Spare blades V6917-REP



Self-adjusting

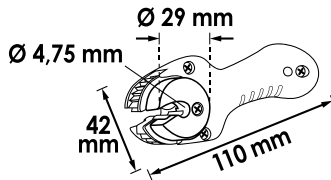

**V6917-REP**, EAN 4047728069199

## Spare cutter wheel for brake line ratcheting tube cutter V6917



**V1782**, EAN 4047728017824

## Tube bending tool

- For tubes made of copper, brass, aluminium and soft steel
- Can be bent up to 90°
- Bending pipes measuring 3 mm, 4.75 mm and 6 mm Ø



- 6 mm Ø
- 4 / 4.75 mm Ø
- 3 mm Ø

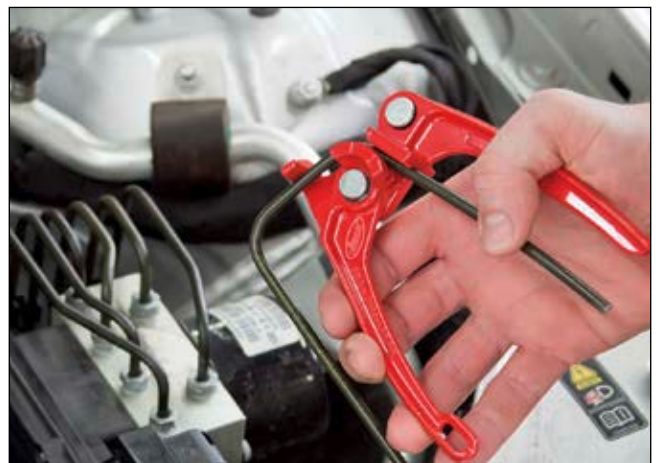



**V7259**, EAN 4047728072595

## Brake line bending tool $\varnothing$ 4.75 mm

- Bending device for easy duplication of brake lines that keep their shape



**V7120**, EAN 4047728077200

## Brake line holding tool

- Non-damaging grip on  $\varnothing$  4.75 mm brake lines thanks to optimised clamping
- The brake line can be re-bent in the installed state to replicate the exact shape of the original
- For steel, copper-nickel and plastic-coated brake lines

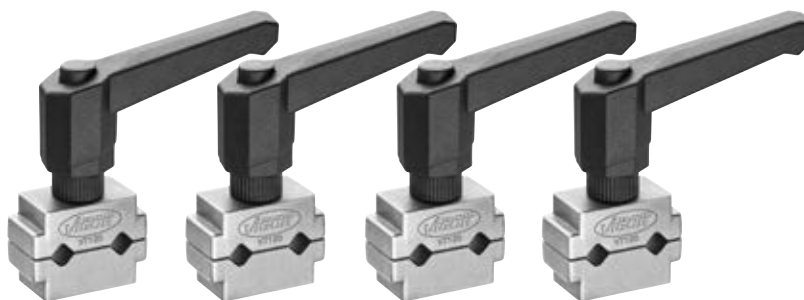

## **Wheels / tyres: for the very best in travel comfort**

Wheels and tyres are crucial for the safety and performance of any vehicle. Our selection of tools and equipment for wheels and tyres offers everything you need to carry out installation, maintenance and repairs professionally. From impact sockets to steering wheel levels and tyre tread gauges – we ensure that you can work with precision and efficiency.

With our products, you can ensure that every wheel is perfectly aligned and every tyre is optimally maintained. This not only improves the driving characteristics and increases the service life of the tyres – but also makes a significant contribution to safety. Whether you need a seasonal tyre change or special repairs, our tools are at your side.

Rely on our robust and reliable wheel and tyre solutions to guarantee you and your customers the best travel comfort and safety.

## **Wheels / tyres**

**Impact sockets**

**281–284**

**Service jacks and jack stands**

**285–288**

**Wheel / tyre tools**

**289–292**



# Impact sockets



**V6311**, EAN 4047728**077798**

## Impact socket · TESLA

- 22.2 mm hexagon or 7/8"
- 21 mm wheel nuts can deform and expand plastically due to weather conditions

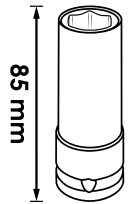

**V4309**, EAN 4047728**043090**

## Impact socket · MERCEDES BENZ

- Operating wheel bolts with a MERCEDES-BENZ special profile
- For the following models:
  - C-Class · GLK (W204)
  - E-Class (W211 · W212 · W207)
  - SLK (W172)
  - M-Class (W164 · W166)
  - CL-Class (W216)
  - S-Class (W221, W222)
  - MAYBACH
- For impact operation

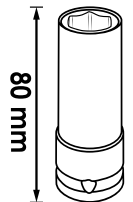

**V6309**, EAN 4047728**075534**

## Impact socket set

- Operation of damaged 19 mm FORD wheel nuts
- For e.g.: FORD B-Max · C-Max · Fiesta · Focus · Mondeo · Transit
- Contents:
  - 18.5 mm impact socket for wheel nuts with missing chrome cap
  - 19.5 mm impact socket for wheel nuts with deformed chrome cap

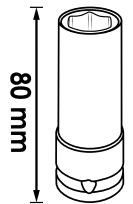
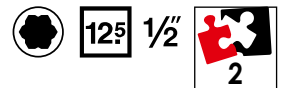

**V6313**, EAN 4047728**083331**

## Impact socket set

- Operation of damaged 21 mm wheel nuts
- 20.5 mm impact socket for wheel nuts with missing chrome cap
- 21.5 mm impact socket for wheel nuts with deformed chrome cap



**NEW**

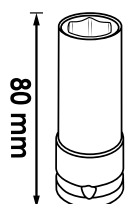
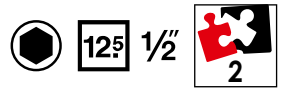

VIGOR No.	■	L mm	EAN 4047728+
V6313-20.5	12.5 1/2	80	083348
V6313-21.5	12.5 1/2	80	083355



**V5930**, EAN 4047728**059305**

**Impact socket · long**

- Damage-free operation of wheel bolts by rotating plastic sleeve
- For impact operation



Size 17 mm



Comparison of standard socket to extra long socket

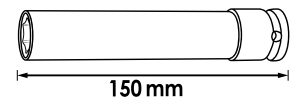

**V5931**, EAN 4047728**060318**

**Impact socket · long**

- Damage-free operation of wheel bolts by rotating plastic sleeve
- For impact operation



Size 19 mm



Comparison of standard socket to extra long socket

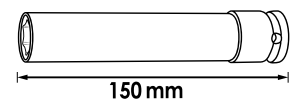

**V5932**, EAN 4047728**079617**

**Impact socket · long**

- Damage-free operation of wheel bolts by rotating plastic sleeve
- For impact operation



Size 21 mm



Comparison of standard socket to extra long socket

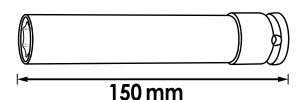

# Impact sockets



V6312/12, EAN 4047728083423

## Impact socket set

- Damage-free operation of wheel bolts by rotating plastic sleeve
- Comprehensive set with all necessary nut-drivers
- Size 15 · 17 · 18.5 · 19 · 19.5 · 20.5 · 21 · 21.5 · 22 · 22.2
- KIA · HYUNDAI · MERCEDES-BENZ special profiles



**NEW**



**V5933/3**, EAN 4047728**079624**

## Impact socket set · extra long

- Damage-free operation of wheel bolts by rotating plastic sleeve
- Extra long design
- Sizes 17 · 19 · 21 mm
- For impact operation

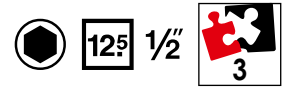

VIGOR No.	□	∅	Size	mm	EAN 4047728+
V5930	12.5	26	17 mm	150	059305
V5931	12.5	28	19 mm	150	060318
V5932	12.5	30	21 mm	150	079617



**V2522**, EAN 4047728**025225**

## Impact socket set

- For impact operation

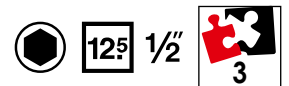

VIGOR No.	Size	mm	EAN 4047728+
V2472	17 mm	85	024723
V2473	19 mm	85	024730
V2474	21 mm	85	024747



**V2257**, EAN 4047728**022576**

## Impact socket set

- For impact operation

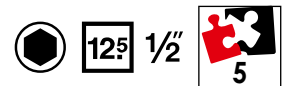

VIGOR No.	Size	mm	EAN 4047728+
V2471	15 mm	85	024716
V2472	17 mm	85	024723
V2473	19 mm	85	024730
V2474	21 mm	85	024747
V2475	22 mm	85	024754



# Service jacks and jack stands



**V2481**, EAN 4047728**024815**

## Hydraulic aluminium service jack 1.35 tonnes

- Wheel change on the vehicle or repairs under the vehicle, for which a lifting platform is not necessary
- $\approx$  10 kg

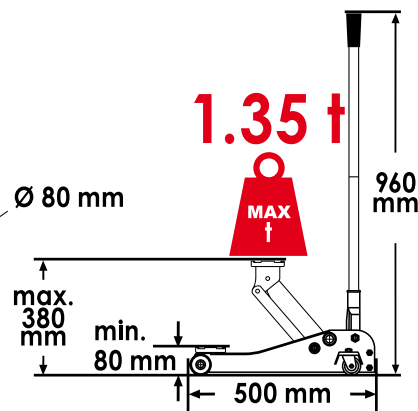
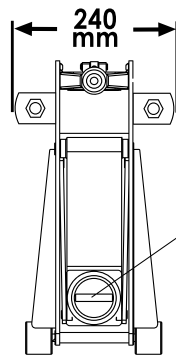

Aluminium – only 10 kg

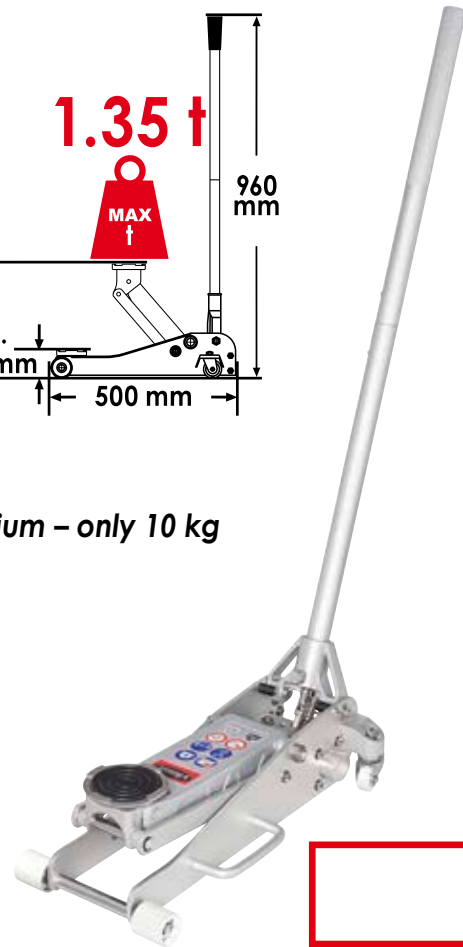

VIGOR No.	Designation	EAN 4047728+
V2631	Fixed castor (pair)	026314
V2632	Swivel castor (pair)	026321
V2639	Hydraulic unit	026390
V2640	Rubber pad	026406

**V6028**, EAN 4047728**060288**

## Hydraulic service jack 2 tonnes · ultra-flat

- Wheel change on the vehicle or repairs under the vehicle, for which a lifting platform is not necessary
- Solid rubber pad for firm hold
- Fast lift thanks to turbo-lift function
- Robust steel body - guarantees high quality
- Quiet castors made from Polyurethane
- $\approx$  32 kg

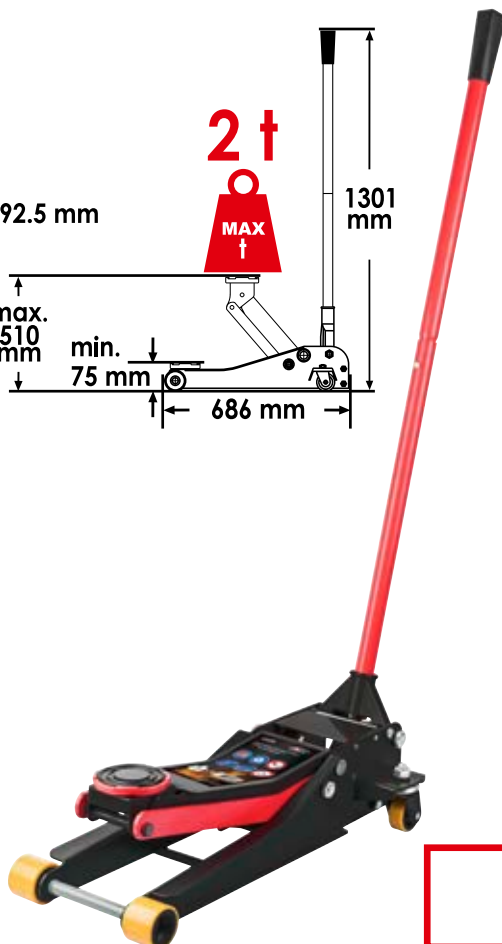
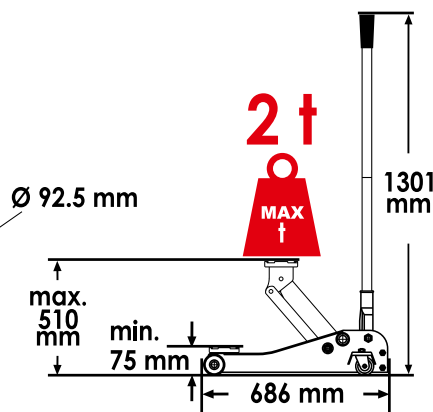
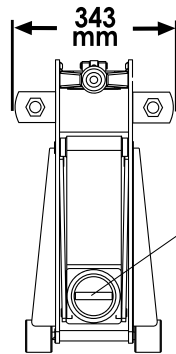

VIGOR No.	Designation	EAN 4047728+
V6028-1	Fixed castor (pair)	062503
V6028-2	Swivel castor (pair)	062497
V6028-3	Rubber pad	062480
V6028-4	Hydraulic unit for V6028	062473



## V6031, EAN 4047728071109

### Hydraulic service jack 2 tonnes · extra long

- Wheel change on the vehicle or repairs under the vehicle, for which a lifting platform is not necessary
- $\approx$  42 kg

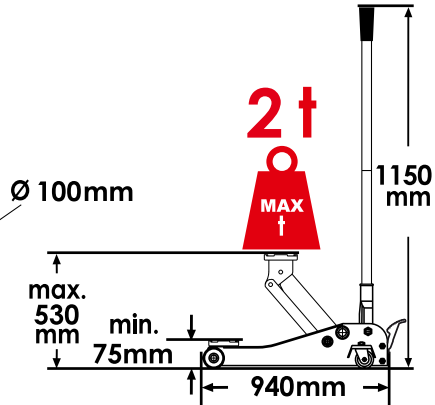
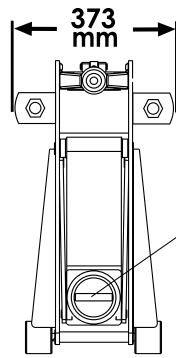

VIGOR No.	Designation	EAN 4047728+
V6031-1	Fixed castor (pair)	075879
V6031-2	Swivel castor (pair)	075886
V6031-3	Rubber pad	075893

## V6029, EAN 4047728069786

### Hydraulic service jack 3 tonnes

- Wheel change on the vehicle or repairs under the vehicle, for which a lifting platform is not necessary
- $\approx$  31 kg
- Compact design
- Quiet castors made from Polyurethane

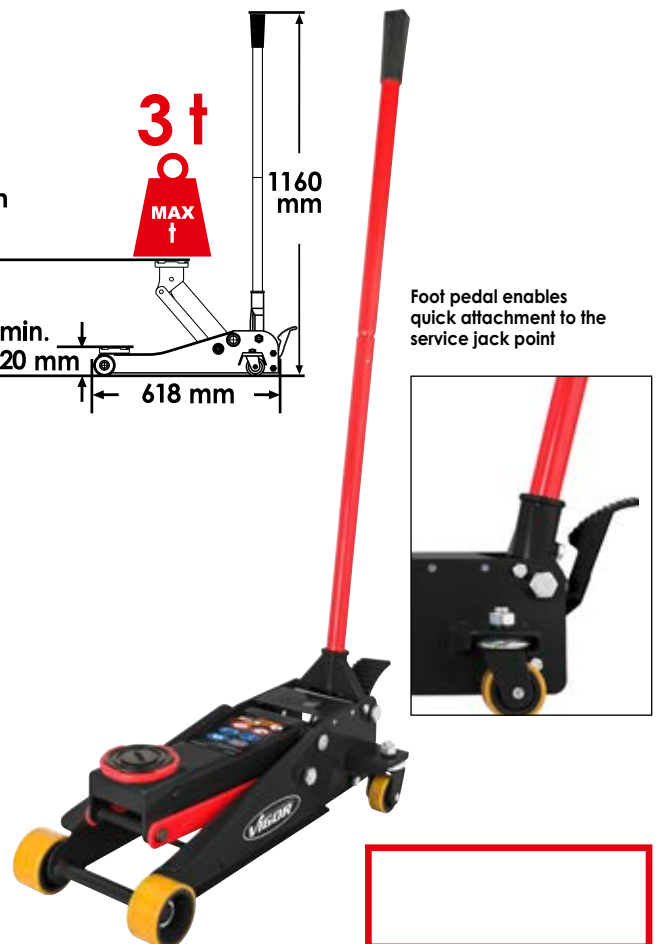
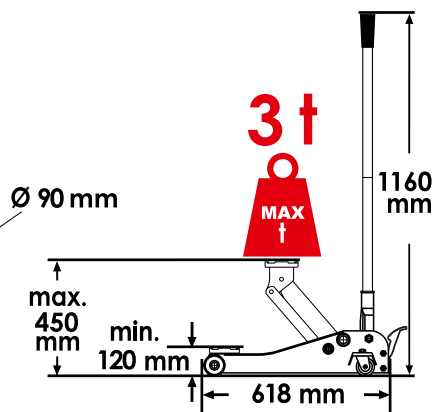
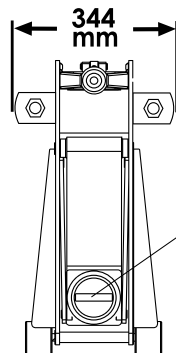

Foot pedal enables quick attachment to the service jack point

VIGOR No.	Designation	EAN 4047728+
V6029-1	Fixed castor (pair)	075855
V6029-2	Swivel castor (pair)	075848
V6029-3	Rubber pad	075862



# Service jacks and jack stands



**V2478**, EAN 4047728024785

## Hydraulic bottle jack 6 tonnes

- Vertical and horizontal applications
- $\approx$  4.4 kg



**V2477**, EAN 4047728024778

## Jack stand set 3 tonnes

- $\approx$  5.2 kg per pair
- Loading capacity: 3 tonnes
- Height 315 – 460 mm
- Depth: 230 mm



VIGOR No.	Designation	EAN
V2762	Rubber pad	027625



**V2648**, EAN 4047728**026482**

**Jack stand set 6 tonnes**

- 11 kg per pair
- Loading capacity: 6 tonnes
- Height 370 – 575 mm
- Depth: 300 mm

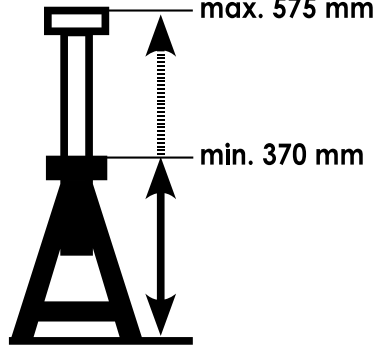

VIGOR No.	Designation	EAN 4047728+
V2762	Rubber pad	027625



## V2512, EAN 4047728025126

### Balance weight remover set

- Removal of balance weights from light-alloy rims on passenger cars and motorcycles
- Solvent resistant
- Blunt edges may be sharpened with a file
- Also suitable for removing labels and stickers
- No damage to surfaces



VIGOR No.	Height mm	Length mm	EAN 4047728+
V2513	19	500	025133
V2514	22	500	025140
V2515	25	500	025157
V2516	38	500	025164



## V1657, EAN 4047728016575

### Balance weight pliers

- Fastening, loosening and cutting balance weights

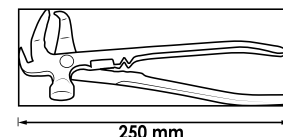

## V1584, EAN 4047728015844

### Tyre tread depth gauge

- Detecting wear patterns on tyres, brake blocks and brake pads
- Zero-setting in any position
- 3 V (CR 2032)–240 mAh



Large LCD display  
Can be switched between mm/inches



**V1423**, EAN 4047728014236

## Tyre pressure gauge

- Quick tyre pressure check
- Small and handy
- Digital display
- Measuring ranges:
  - 0.15 - 7 bar
  - 2 - 99.5 PSI
  - 15 - 70 KPA
- 3 V (CR 2032) - 240 mAh



Automatic shut-off  
after 90 sec.

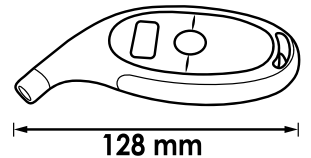

## Rubber hammer

- Loosening rusted rims during a wheel change



Plastic handle

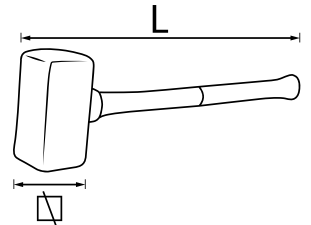

Non-rebound due  
to steel-ball filling

VIGOR No.	mm	kg	EAN 4047728+
V2235	50	2.5 kg	022354
V2234	74	5 kg	022347

**V1571**, EAN 4047728015714

## Steering wheel level

- Alignment of the steering wheel during axle alignments and work around the steering column
- Quick installation
- Simple adjustment to the steering wheel
- Easy to read
- Universal use for passenger cars, vans and trucks
- Use of the steering wheel level prevents incorrect steering wheel positions
- An exact axle alignment should always be carried out using a calibrated alignment device

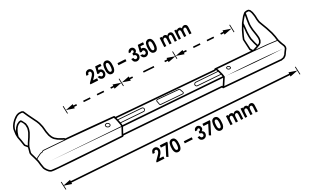

**V7181**, EAN 4047728**071819**

## Tap and die set for wheel bolts and wheel nuts

- Damaged or rusty threads can result in incorrect torque values
- Repairing and cleaning of wheel bolts and wheel nuts with inside and outside thread
- Can be used directly on the vehicle
- TIN-HSS coated surface
- In plastic case
- Suitable for the thread sizes:
  - M12x1.25 mm
  - M12x1.5 mm
  - M14x1.5 mm



*Damaged or rusty threads can result in incorrect torque values*

### Inside thread



### Outside thread

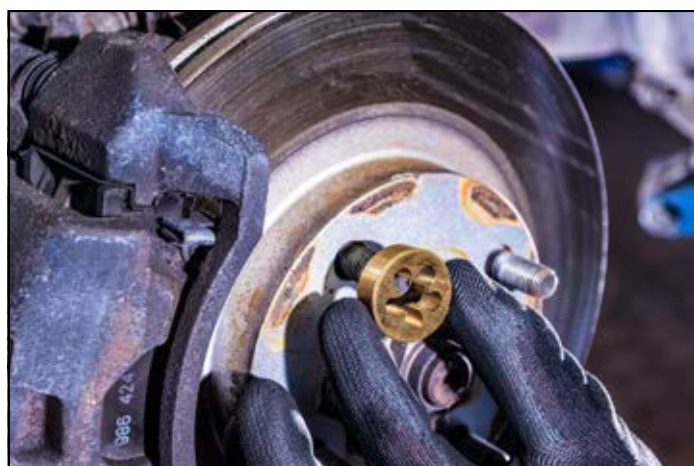

VIGOR No.	Designation	Design	EAN 4047728+
V7181-1	Die · M12x1.25 TIN		071840
V7181-2	Die · M12x1.5 TIN		071833
V7181-3	Die · M14x1.5 mm TIN		071826
V7181-4	Hand tap · M12x1.25 TIN		071864
V7181-5	Hand tap · M12x1.5 TIN		071857
V7181-6	Hand tap · M14x1.5 TIN		071871



**V7001**, EAN 4047728**075060**

## Universal rim lock removal set

- Malleable rim keys for loosening almost all rim locks
- Also for rim locks with clover leaf profile, among others
- Malleable rim keys adapt to the profile by hammer strike
- Can be used on both sides
- Multiple deformation of a key side not possible
- Contents:
  - 8 rim keys
  - 2 adapters
  - Socket □ 12.5 mm (1/2") - size 24 mm
  - Impact body
  - Centring pin
  - Hand guard trim



**V7001/4**, EAN 4047728**075336**

## Rim key set

- Key set with Ø 13 mm and 15 mm can be used on both sides
- For universal rim lock removal set V7001
- Material: AHSS (carbon steel)

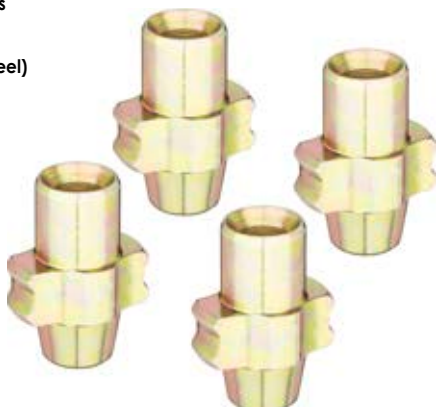

## Body: precision and quality for every vehicle

The body of a vehicle is not only an aesthetic feature – it also plays a crucial role in the safety and integrity of the vehicle. Our assortment of body tools helps you to carry out repairs, restorations and modifications with the utmost precision. From bearing pullers and plastic repair sets to induction heaters – we offer a wide range of products tailored to the specific needs of bodywork.

Whether it's everyday touch-ups or extensive restorations – our body tools will help you tackle any project with confidence and achieve results that are sure to impress both you and your customers.

## Body

**Wiper arm puller set**

**294**

**Repair and installation sets**

**295**

**Induction heater and accessories**

**296–298**



**V2523**, EAN 4047728**025232**

## Wiper arm puller set

- Universally usable
- For easy removal of all common wiper arms
- Optimum usability options with rusted and stuck wiper arms
- Best possible protection for integrated wiper nozzles when used with a sliding hammer



VIGOR No.	Designation	Design	EAN 4047728+
V4153	Puller · universal		041539
V4154	Sliding hammer		041546
V4155	Pressure spindle		041553
V4156	Spindle extension		041560
V4157	Spindle attachment		041577
V4159	Gripper no. 1		041591
V4160	Gripper no. 2		041607
V4161	Gripper no. 3		041614
V4163	Gripper no. 5		041638
V4164	Gripper no. 6		041645
V4165	Gripper no. 7		041652
V4158	Gripper no. 8		041584





**V3551N**, EAN 4047728**075084**

## Repair set for plastic parts

- Repair and reinforcement of plastic parts, such as cracked light bars and housing parts
- Extensive and practical for household, workshop or handicrafts
- 3-in-1 function with replaceable fixtures
- Stainless steel staples
- Power: 50 watts
- Maximum useful life: 35 min
- Charging time: 3.5 hours
- Included in delivery:
  - 50 type W repair staples / Ø 0.6 mm
  - 50 type W repair staples / Ø 0.8 mm
  - 5 welding rods each, material PE, PS, ABS
  - 10 welding rods, material PP
  - 2 reinforced grids

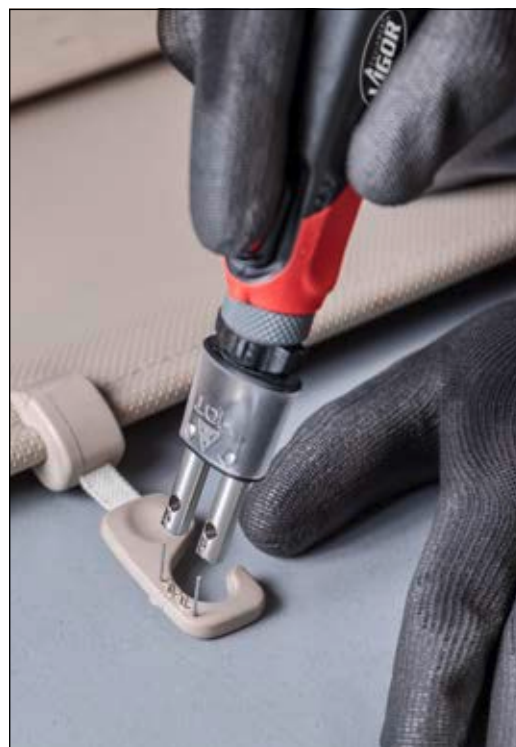

VIGOR No.	Designation	Design		EAN 4047728+
<b>V3670N</b>	Replacement staples · 0.8 mm · V-formed		100	<b>075671</b>
<b>V3671N</b>	Replacement staples · 0.6 mm · V-formed		100	<b>075688</b>
<b>V3672N</b>	Replacement staples · 0.8 mm · W-formed		100	<b>075695</b>
<b>V3673N</b>	Replacement staples · 0.6 mm · W-formed		100	<b>075701</b>
<b>V3676N</b>	Replacement staples · 0.6 mm · U-formed		100	<b>075718</b>
<b>V3677N</b>	Replacement staples · 0.8 mm · U-formed		100	<b>075725</b>
<b>V3551N-ABS</b>	Plastic welding rods Abs		10	<b>077170</b>
<b>V3551N-PE</b>	Plastic welding rods Pe		10	<b>077149</b>
<b>V3551N-PP</b>	Plastic welding rods Pp		10	<b>077156</b>
<b>V3551N-PS</b>	Plastic welding rods Ps		10	<b>077163</b>
<b>V3551N-W</b>	Reinforced grids		5	<b>077132</b>



**V4891**, EAN 4047728**048910**

## Induction heater

- Quick, simple removal of parts on vehicles by heating
- Extremely versatile in the car body and commercial vehicle sector due to extensive standard accessories
- Precise heating in just a few seconds with cutting-edge microprocessor technology
- Easy to transport thanks to plastic case
- Prevention of overheating with a simultaneously high degree of efficiency due to two fans
- Connecting cable: 3 m
- Reel hose length: 700 mm
- Controlled fan cooling
- Tube coils: heating pipes, bolts, profiles of various diameters
- Flexible coil: for loosening parts that are difficult to access due to the use of a special winding wire
- Flat coil for heating the car body and sheet metal, makes it easier to remove stickers, sealants etc.
- Robust IGBT transistor technology
- Short circuit and idling test
- Automatic adaptation to resonance frequency
- Frequency: 25 kHz – 60 kHz
- 1.5 kW output

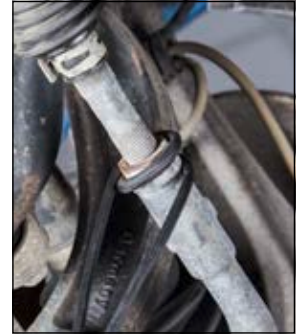
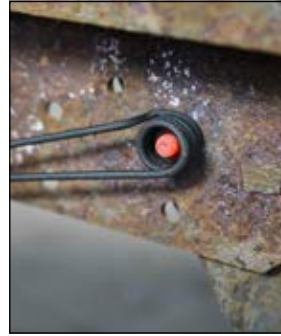

*Accurately positioned heating within a few seconds due to cutting-edge microprocessor technology*



Including 4 coils



**V4891-1**, EAN 4047728**049573**

## Tube coil

- Total length: 222 mm
- Vertical alignment
- Inside diameter 19 mm, up to maximum M8



**V4891-2**, EAN 4047728**049580**

## Flexible coil

- Total length: 750 mm
- Flexible use on individual motor vehicle components
- For hard-to-reach places

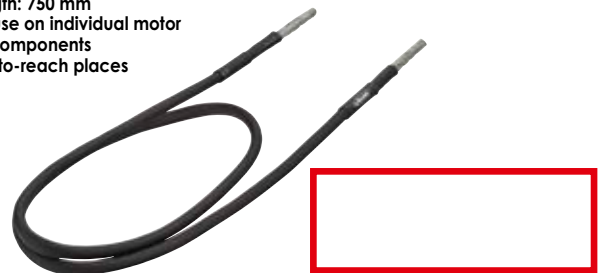

**V4891-3**, EAN 4047728**049597**

## Tube coil

- Total length: 225 mm
- Vertical alignment
- Inside diameter 26 mm, up to maximum M12



**V4891-4**, EAN 4047728**049603**

## Flat coil

- Optimal for heating surfaces
- Heating of flat screws
- Total length: 227 mm
- Inside diameter: 24 mm
- Outer diameter 45 mm

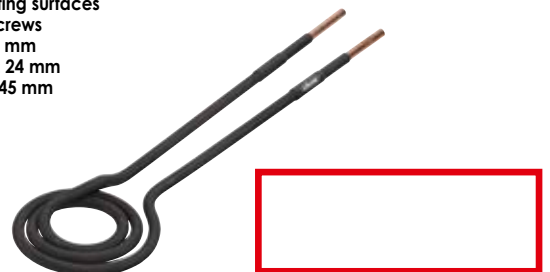

**V4891/6**, EAN 4047728062206

## Expansion set for induction coils

- Set consisting of:
  - V4891-5 (Focus coil for punctual heating)
  - V4891-6 (Tube coil)
  - V4891-7 (Tube coil)
  - V4891-8 (Flexible coil, ceramic protection)
  - V4891-9 (Tube coil)
  - V4891-10 (tube coil, lateral)
- Compatible with induction heater V4891 and V4891-1.0



**V4891-5**, EAN 4047728062152

## Focus coil · for punctual heating

- For heating components which can not be reached with standard coils
- Coil for heating with pinpoint accuracy, to concentrate the energy
- During heating, a distance of approx. 2 – 4 mm from the workpiece must be maintained to prevent damage to the coil
- Total length: 210 mm



**V4891-6**, EAN 4047728062169

## Tube coil

- Total length: 220 mm
- Vertical alignment
- Inside diameter 15 mm, up to maximum M6



**V4891-7**, EAN 4047728062176

## Tube coil

- Total length: 240 mm
- Horizontal alignment
- Inside diameter 45 mm, up to maximum M22

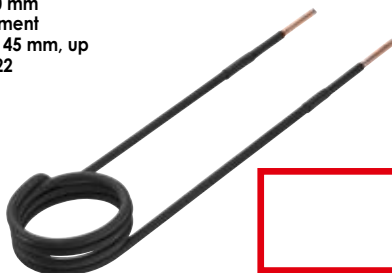

**V4891-8**, EAN 4047728062183

## Flexible coil · ceramic protection

- Total length: 800 mm
- Higher temperature resistance
- The ceramic coating extends the service life
- Self-adjusting distance for smaller components

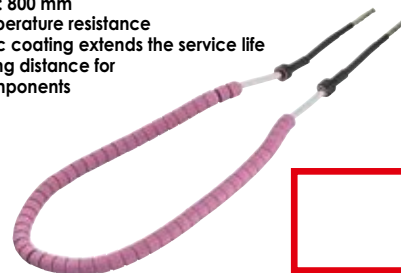

**V4891-9**, EAN 4047728062190

## Tube coil

- Total length: 220 mm
- Vertical alignment
- Inside diameter 45 mm, up to maximum M22



**V4891-10**, EAN 4047728062343

## Tube coil · lateral

- Total length: 230 mm
- Horizontal alignment
- Inside diameter 23 mm, up to maximum M10

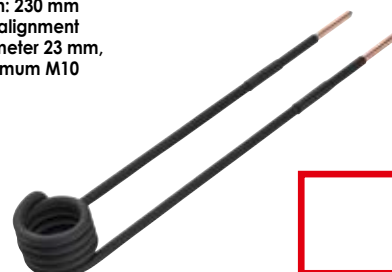

**V4891-3.5**, EAN 4047728072779

**Induction heater · truck 3.5 KW**

- Powerful 3.5 KW variant for motor vehicles and commercial vehicle applications
- Efficient method of heating, without damaging surrounding components
- Water-cooled
- Portable, despite high performance
- Output power can be precisely adjusted for the application field
- Force can be output in increments between 10-100%
- As-delivered condition including coolant
- Precise heating of components and elements
- Operating information via LED on the coil head
- Additional fan in the housing provides overheating protection for the hardware components
- Precise heating in just a few seconds with cutting-edge microprocessor technology



**V4891-3.5-1**, EAN 4047728072786

**Expansion coil · Wheel bolt**

- Extra slim design allows for precise heating of wheel bolts



**V4891-3.5-2**, EAN 4047728072793

**Standard coil · lateral**



**V4891-3.5-3**, EAN 4047728072809

**Reducer**

- Reducer for adapting plug-in coil V4891-3.5-4



**V4891-3.5-4**, EAN 4047728072816

**Plug-in coil · 26 mm**

- Only together with V4891-3.5-3



**V4891-3.5-6**, EAN 4047728072892

**Round coil · 32 mm**



**V4891-3.5-5**, EAN 4047728072823

**Coolant · 3 l**



**V3863**, EAN 4047728**038638**

## Shock absorber assembly tool set

- Installation / removal on shock absorbers with rebound spring
- Clamping pieces with V-formed plastic inserts enable fixation in final stop position without causing any damage
- For: BMW · FIAT · FORD · MERCEDES-BENZ · NISSAN · PEUGEOT · TOYOTA
- Contents:
  - Special base component
  - Sturdy threaded spindle M12 with special receptacle
  - Universal clamping piece with V-formed plastic inserts

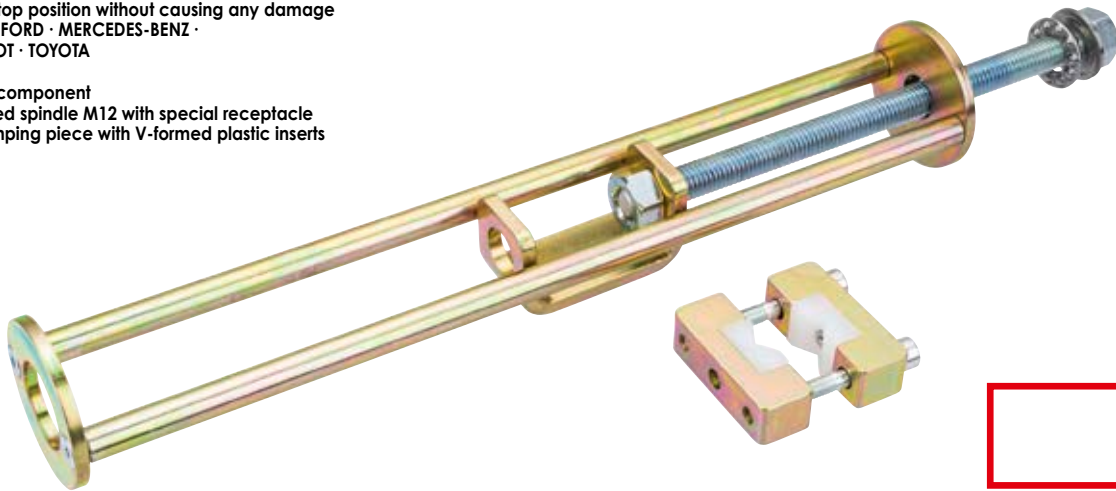

**V3661**, EAN 4047728**036610**  
Clamping piece with plastic protective jaws (universal)



**V4126N**, EAN 4047728**078566**

## Clamping screw removal tool set

- To actuate the clamping screw on the VAG multi-link axle in the installed state
- No pressing or pulling on the aluminium steering knuckle
- Drilling guides guarantee exact drilling of the steel screw
- For example:
  - AUDI A4 model year 2015 → · A5 model year 2016 → · A6 model year 2018 → · A7 model year 2017 → · Q5 model year 2016 → · Q7 model year 2015 → · Q8 model year 2018 → · E-Tron model year 2018 →
  - VW Touareg model year 2017 →
- Contents:
  - 3 high-performance drills (HSS cobalt) size: 6 · 8.5 · 10 mm
  - 1 pressure clamp
  - 1 drift punch



VIGOR No.	∅	EAN 4047728+
<b>V4248</b>	6	<b>042482</b>
<b>V4249</b>	8.5	<b>042499</b>
<b>V4250</b>	10	<b>042505</b>



**V6452**, EAN 4047728**064521**

## Shock absorber tool set

- Professional repair work on spring struts (counterholding the piston rod when removing and installing)
- Operation of shock absorbing nuts on strut bearings
- For the most common vehicle types

• Contents:

- Open reversible ratchet, size 21 mm, 12-point
- Open 6-point sockets:
  - 12.5 mm (1/2"), SW 16 · 17 · 18 · 19 · 21 · 22 · 24 mm
  - 12.5 mm (1/2") screwdriver socket, size 6 · 7 · 8 mm
  - 12.5 mm (1/2") extension: 250 mm
  - 12.5 mm (1/2") sockets, oval 5x8 mm, 6x8 mm



VIGOR No.	Designation	Design	EAN 4047728+
V6452-1	Reversible ratchet · open		075220
V6452-5	Socket special profile · MERCEDES-BENZ · 5 mm		075206
V6452-6	Socket special profile · MERCEDES-BENZ · 6 mm		075213
V6452-16	Socket · 16 mm		075091
V6452-17	Socket · 17 mm		075107
V6452-18	Socket · 18 mm		075114
V6452-19	Socket · 19 mm		075121
V6452-21	Socket · 21 mm		075138
V6452-22	Socket · 22 mm		075145
V6452-24	Socket · 24 mm		075152
V6452-250	Sliding T-handle · 250 mm		075169
V6452-H6	6-point socket · 6 mm		075176
V6452-H7	6-point socket · 7 mm		075183
V6452-H8	6-point socket · 8 mm		075190



**V6956**, EAN 4047728069564

## Universal axle lever

- Proper, careful installation and removal of axle components such as ball joints and wishbones for example
- Chain adjustment enables flexible use and adaptation to different dimensions and circumstances
- High quality spindle ensures easy working and a high transmission of force
- Direct use on the vehicle without requiring a second person
- Rubber-insulated supporting surface ensures secure hold on the vehicle
- For operation with reversible ratchet or air ratchet

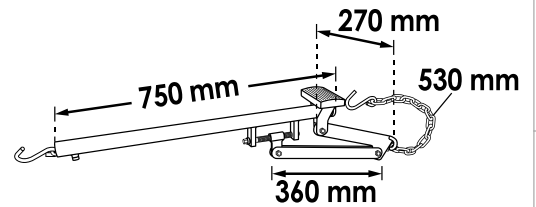

**V4642**, EAN 4047728046428

## Cardan shaft puller · universal

- Proper disassembly of the homokinetic joint and the rubber boots of the drive shaft
- Extra-wide frame, also for large hinges

*Specially shaped clamping jaws ensure a secure grip on the drive shaft*

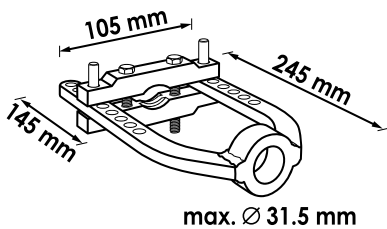

**V7525**, EAN 4047728**075251**

## Universal pressing support

- Removal and installation of bearings and bushings together with workshop presses
- Optimised three-point alignment of workpieces on the workshop press
- Extensive adjustability allows almost all workpieces to be aligned parallel to the workshop press, thus increasing safety during use
- Lateral stop position for a secure hold on the workshop press
- Swivel base enables quick and easy positioning on the base
- Maximum permitted loading capacity: 20 tonnes





**V4636N**, EAN 4047728078719

## Inner bearing extractor

- For inner bearing rings that rest against the wheel hub
- For rings in the clamping range 33 – 60 mm
- Replaceable cones with  $\varnothing$  32 mm and  $\varnothing$  40 mm for extensive market coverage
- Also suitable for models with ABS cage, e.g. VW Golf 4
- Fixing screw prevents the arms from slipping off
- Operation with reversible ratchet



## Included in delivery

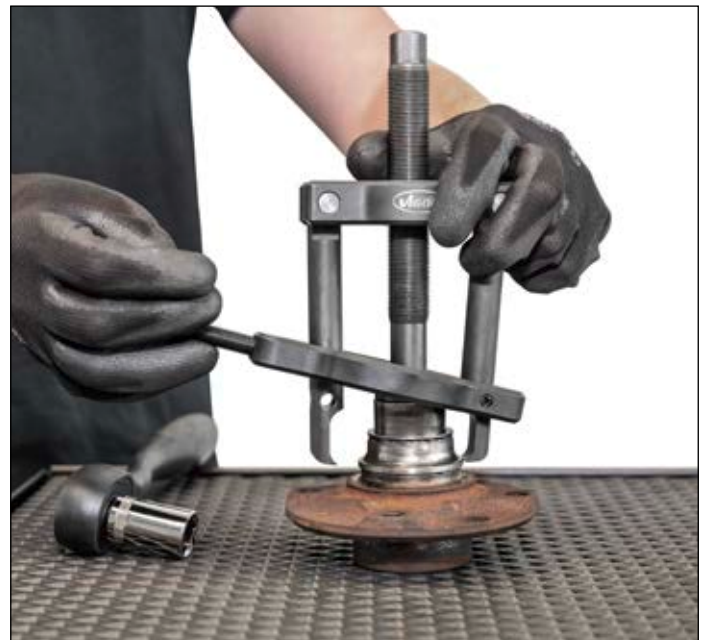
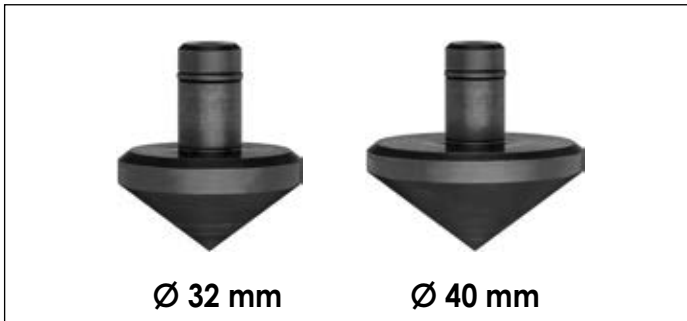

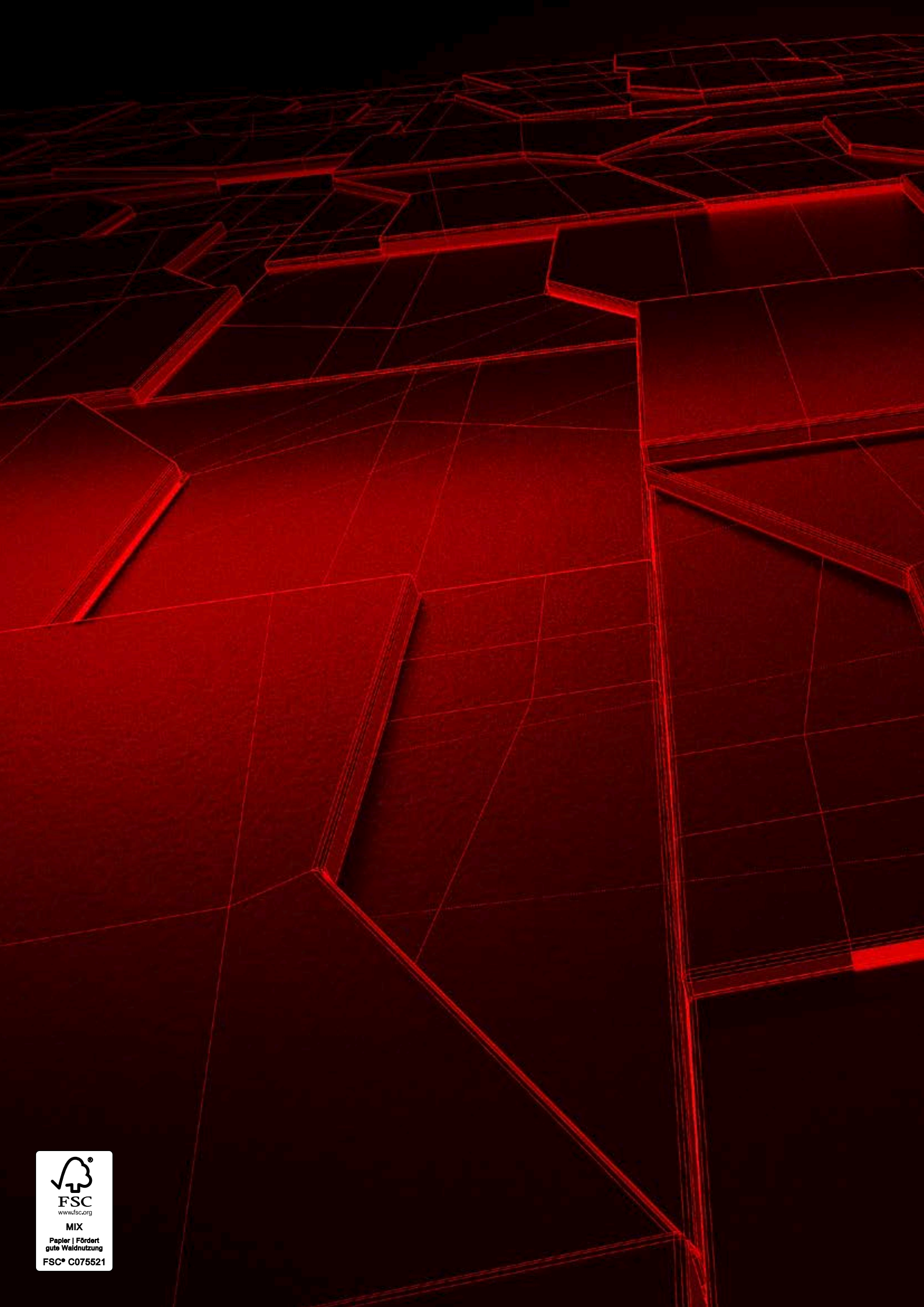



EINFACH VIGOR.



Please contact us:

Copyright 2025/26 by VIGOR GmbH

VIGOR GmbH · Am Langen Siepen 13-15 · D-42857 Remscheid · GERMANY [info@vigor-equipment.com](mailto:info@vigor-equipment.com) · [www.vigor-equipment.com](http://www.vigor-equipment.com)

Products available as long as stock lasts! All rights reserved regarding technical modifications. Figures may not always correspond to the original and are thus not binding! We accept no liability for printing errors!